

1 2 3 4 5 6 7 8

A

B

C

D

E

F

A

B

C

D

E

F

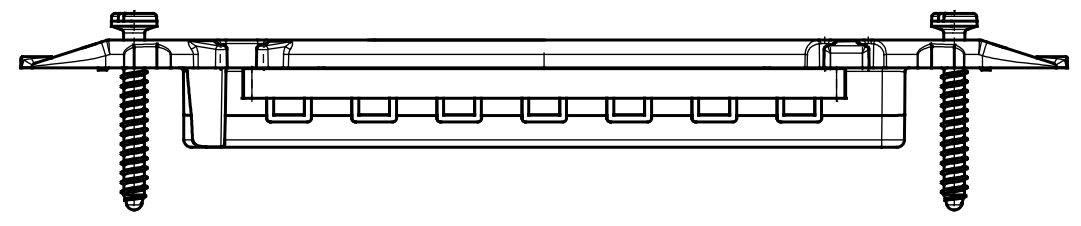

135.5

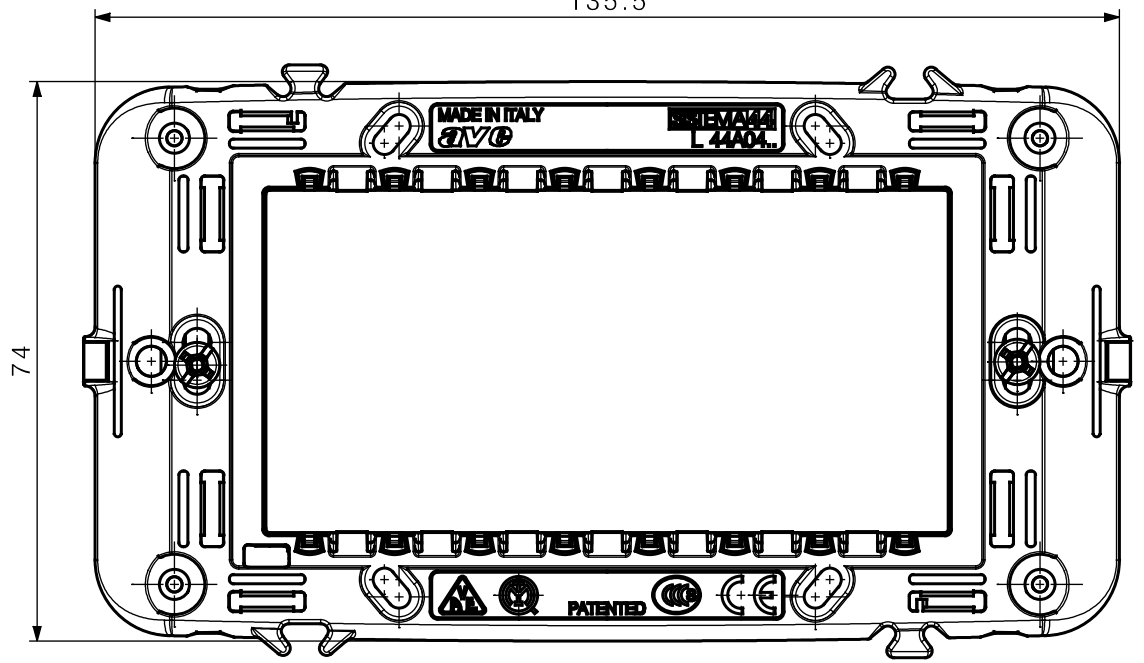

74

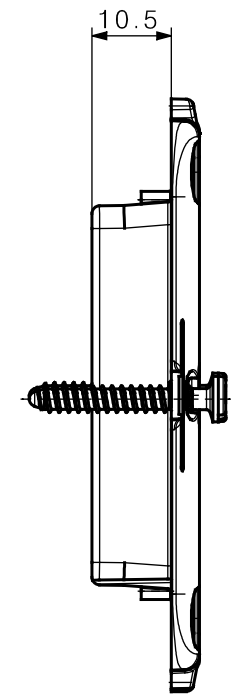

10.5

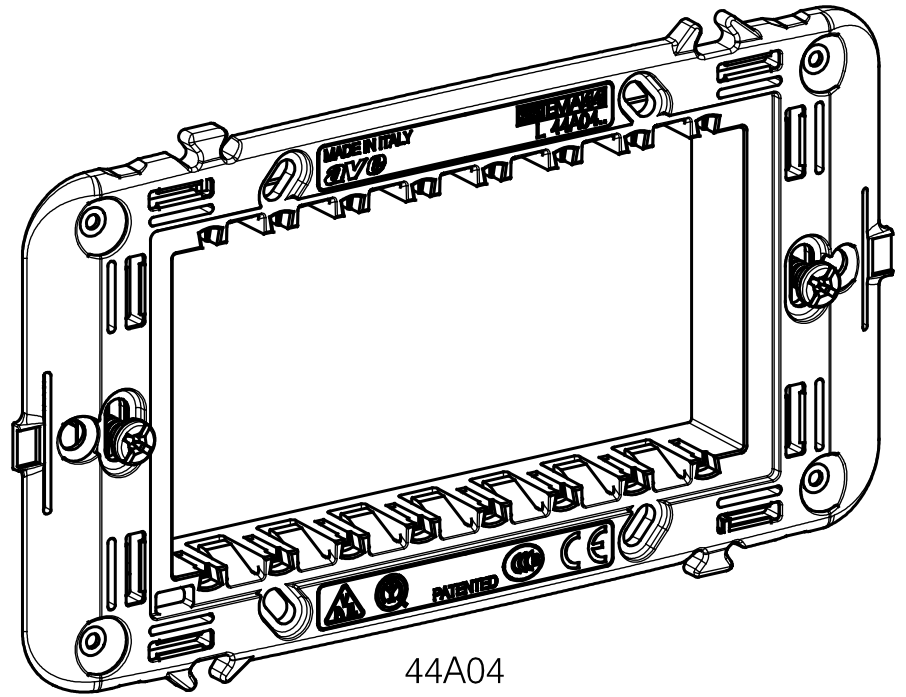
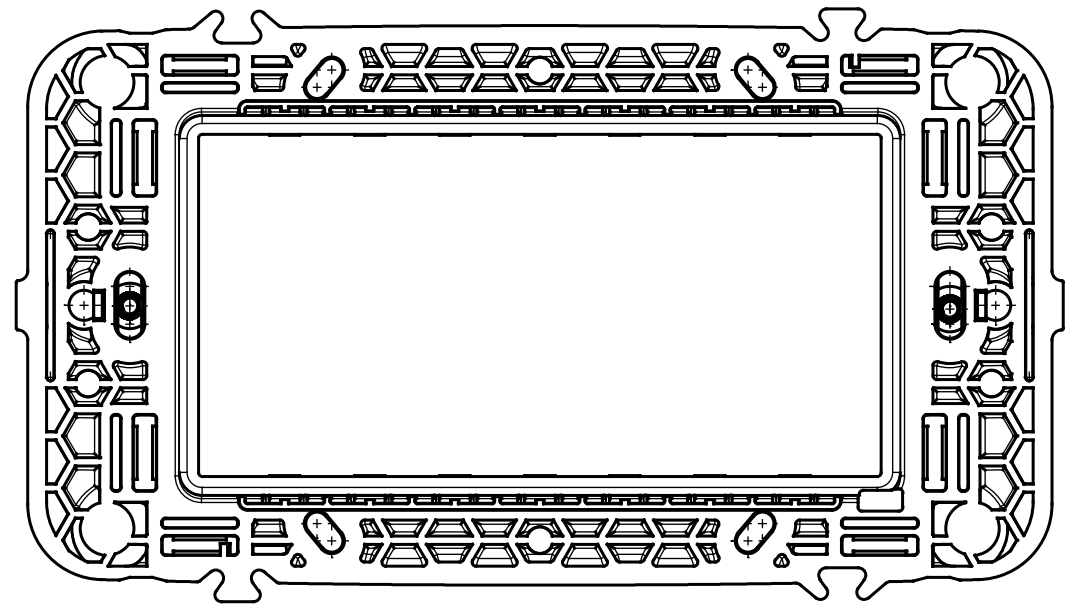

44A04

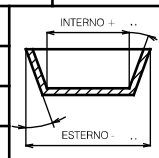
| | | | | | |
|--|------|-----------------------------|---|---------------------------------------|--------------------|
| REV. | DIS. | CONTR. | DATA | DESCRIZIONE | DOCUMENTO |
| .. | .. | .. | .. | .. | .. |
| TOLLERANZE GEN. : AVE N° SP0001 AGG.02 | | TOLLERANZE GENERALI D120 | | TOLL. GENERALE DI DISASSAMENTO 0,1 | MATERIALE .. |
| | | | | TRATTAMENTO .. | |
|  | | CAD. : CATIA V5 |  | INGOMBRI ARMATURA 4 MOD SISTEMA 44 | |
| | | SEZ. : .. | | SCALA 1:1 | |
| | | FILE : .. | | | |
| | | ENTE : PRE | | | |
| | | DATA : 14/03/19 | VOLUME (mm³) .. | PROGETTO N° | DISEGNO N° |
| CART_PART.DWG AGG.00 | | DIS. : SD | CONTR. : DS | APPR. : DR | 1300 |
| | | | | 44A04 | REVISIONE N° 00 |
| LA PROPRIETA' DI QUESTO DISEGNO E' RISERVATA A TERMINI DI LEGGE CON DIVIETO DI RIPRODUZIONE O DI COMUNICAZIONE A TERZI SENZA PREVENTIVA AUTORIZZAZIONE SCRITTA | | | | | |

1 2 3 4 5 6 7 8