







Pulsanti 250V~
Push-buttons 250V~

Domus	Class	Descrizione Description	Info	€	□ □
		<p>□ 441056F ■ 449056F</p> <p>Doppio pulsante 1P NA + 1P NA 10A con frecce direzionali - illuminabile (solo versione Domus - Class) - senza interblocco: è consentita la chiusura contemporanea dei 2 circuiti - 1 modulo</p> <p><i>1P NO + 1P NO 10A double push-button with arrows - lightable - without interblock : the simultaneous closure of the 2 circuits is allowed - 1 module</i></p>	1	10	
441056F	449056F				
		<p>□ 441017 ■ 449017</p> <p>Pulsante 1P NA+NC 10A a tirante - cordone in materiale isolante 1,5 m - 1 modulo</p> <p><i>1P NO+NC 10A cord operated push-button - insulating material cord 1,5 m - 1 module</i></p>	1	10	
441017	449017				
		<p>□ 441005TP/2</p> <p>Pulsante 1P NA 10A con targhetta portanome retroilluminabile - illuminazione a mezzo lampada con attacco E10 10x28 mm tipo T10 1,5W max ad incandescenza o led - fornito senza lampada - fornito con cartoncino portanome personalizzabile - 2 moduli</p> <p><i>1P NO 10A push-button with lightable name tag - illumination by incandescent or led lamp E10 10x28 mm T10 1,5W max type - supplied with customizable name tag card - supplied without lamp - 2 modules</i></p>	1	6	
441005TP/2					
		<p>■ 442025RS/2</p> <p>Pulsante di emergenza 1P NA+NC 10A a tasto largo illuminabile - rosso - 2 moduli</p> <p><i>1P NO+NC 10A large emergency push-button - red - 2 modules</i></p>	1	6	
442025RS/2					

- Note:**
- ✓ gli articoli illuminabili sono forniti senza lampada di segnalazione
 - ✓ 44..056F consentendo la chiusura contemporanea di due circuiti non sono adatti all'inversione di marcia di motori (es. tapparelle, ecc.)
- Notes:**
- ✓ lightable articles are supplied without lamp
 - ✓ Since 44..056F allow the simultaneous closure of two circuits, they are not suitable for motor reversing (ex. rolling shutter, ecc.)

Sistema 45

Pulsante con targhetta portanome Push button with name tag

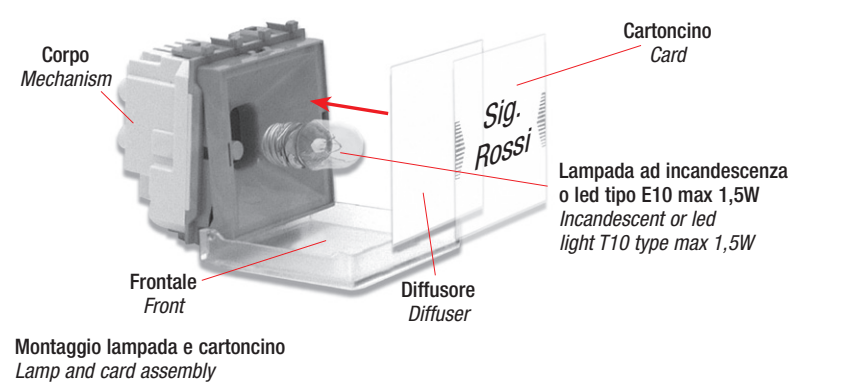

Le dimensioni, salvo diversamente specificato, sono in mm
Dimensions, except where otherwise specified, are in mm

□ Imballo Minimo pcs
Min. Packaging pcs

□ Imballo Standard pcs
Std. Packaging pcs