













# Aspiratori centrifughi "FLOo" - IPX4

## Centrifugal fans IPX4 - "FLOo"

ID 1111215583  
WWW.TUV.COM

Descrizione Description		Info	€	□	□	625
 <p><b>VNDC80</b> <b>VNDC80T</b> <b>VNDC80HT</b></p>  	<p><b>VNDC80</b> Aspiratore centrifugo compatto Ø80mm - motore con cuscinetti a sfera - portata massima 104 m³/h - per installazione in bagno, toilette, cucine e piccoli/medi ambienti - montaggio a superficie o ad incasso. Versione base. <i>Compact centrifugal duct fan Ø80mm - ball bearing motor - max air flow 104 m³/h - for installation in bathrooms, toilets, kitchens and small/medium living areas - surface or flush mounting. Basic version.</i></p>			1	1	
	<p><b>VNDC80T</b> Aspiratore centrifugo compatto Ø80mm - motore con cuscinetti a sfera - portata massima 104 m³/h - per installazione in bagno, toilette, cucine e piccoli/medi ambienti - montaggio a superficie o ad incasso. Versione con timer. <i>Compact centrifugal duct fan Ø80mm - ball bearing motor - max air flow 104 m³/h - for installation in bathrooms, toilets, kitchens and small/medium living areas - surface or flush mounting. Timer version.</i></p>			1	1	
	<p><b>VNDC80HT</b> Aspiratore centrifugo compatto Ø80mm - motore con cuscinetti a sfera - portata massima 104 m³/h - per installazione in bagno, toilette, cucine e piccoli/medi ambienti - montaggio a superficie o ad incasso. Versione con umidostato &amp; timer. <i>Compact centrifugal duct fan Ø80mm - ball bearing motor - max air flow 104 m³/h - for installation in bathrooms, toilets, kitchens and small/medium living areas - surface or flush mounting. Humidistat &amp; timer version.</i></p>			1	1	
	<p><b>VNDC100</b> Aspiratore centrifugo compatto Ø100mm - motore con cuscinetti a sfera - portata massima 104 m³/h - per installazione in bagno, toilette, cucine e piccoli/medi ambienti. - montaggio a superficie o ad incasso. Versione base. <i>Compact centrifugal duct fan Ø100mm - ball bearing motor - max air flow 104 m³/h - for installation in bathrooms, toilets, kitchens and small/medium living areas - surface or flush mounting. Basic version.</i></p>			1	1	
 <p><b>VNDC100</b> <b>VNDC100T</b> <b>VNDC100HT</b></p>  	<p><b>VNDC100T</b> Aspiratore centrifugo compatto Ø100mm - motore con cuscinetti a sfera - portata massima 104 m³/h - per installazione in bagno, toilette, cucine e piccoli/medi ambienti - montaggio a superficie o ad incasso. Versione con timer. <i>Compact centrifugal duct fan Ø100mm - ball bearing motor - max air flow 104 m³/h - for installation in bathrooms, toilets, kitchens and small/medium living areas - surface or flush mounting. Timer version.</i></p>			1	1	
	<p><b>VNDC100HT</b> Aspiratore centrifugo compatto Ø100mm - motore con cuscinetti a sfera - portata massima 104 m³/h - per installazione in bagno, toilette, cucine e piccoli/medi ambienti - montaggio a superficie o ad incasso. Versione con umidostato &amp; timer. <i>Compact centrifugal duct fan Ø100mm - ball bearing motor - max air flow 104 m³/h - for installation in bathrooms, toilets, kitchens and small/medium living areas - surface or flush mounting. Humidistat &amp; timer version.</i></p>			1	1	

### Dimensioni (mm) Dimensions (mm)

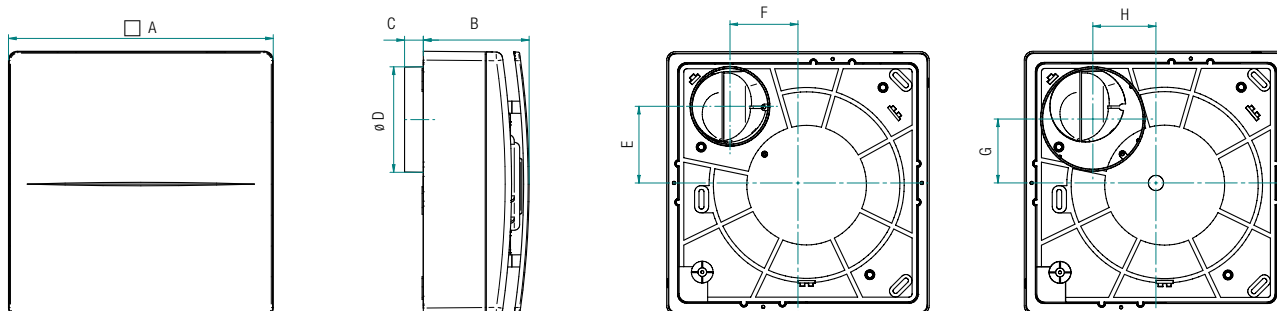

Codice Code	A	B	C	ØD	E	F	G	H
VNDC80 - VNDC80T - VNDC80HT	241,5	96,5	17	73,5	70,5	62,5	-	-
VNDC100 - VNDC100T - VNDC100HT	241,5	96,5	17	96	-	-	59	58

Le dimensioni, salvo diversamente specificato, sono in mm  
Dimensions, except where otherwise specified, are in mm

Imballo Minimo pcs  
Min. Packaging pcs

Imballo Standard pcs  
Std. Packaging pcs

VENTILAZIONE  
VENTILATION