



**Design:**  
B. Dall'Eco  
L. Merletti

# Serie Civili Sistema 44

## System 44 Wiring Accessories

SERIE CIVILI  
WIRING ACCESSORIES



161

Sistema 44  
44 System

Placche  
Vera 44  
VETRO  
Vera 44 GLASS front plates

**162**

Placche  
Vera 44  
ALLUMINIO  
Vera 44 ALUMINIUM front plates

**184**

Placche  
Vera 44  
LEGNO e CORIAN®  
Vera 44 WOOD and CORIAN® front plates

**204**

Placche  
ZAMA 44  
ZAMA 44 front plates

**214**

Placche  
YOUNG 44  
YOUNG 44 front plates

**226**

Placche  
TECNOPOLIMERO 44  
MOULDED 44 front plates

**240**

Placche  
PERSONAL 44  
PERSONAL 44 front plates

**252**

CONFIGURATORE e  
Placche personalizzabili  
CUSTOMIZABLE plates configurator

**258**

# Placche

## Front Plates

162

### I colori delle placche "Ave Touch" VETRO "Ave Touch" GLASS front plate colours



**44PVT1BL**  
Bianco  
finitura lucida  
*Clear white*



**44PVT1GO**  
Grigio argentato  
finitura opaca  
*Frosted silver grey*



**44PVT1NAL**  
Nero assoluto  
finitura lucida  
*Clear absolute black*

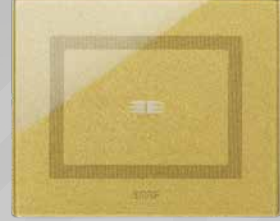

**44PVT1GOLD**  
Gold - finitura lucida  
*Clear gold*



**44PVT1VO**  
Verde acqua - finitura opaca  
*Frosted water green*

### I colori delle placche "Vera 44" VETRO "Vera 44" front plates colours for rectangular box



**44PV3BL**  
Bianco - finitura lucida  
*Clear white*



**44PV3GO**  
Grigio argentato  
finitura opaca  
*Frosted silver grey*

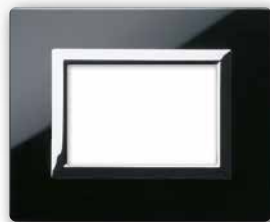

**44PV3NAL**  
Nero assoluto  
finitura lucida  
*Clear absolute black*

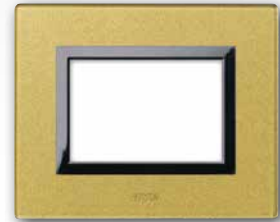

**44PV3GOLD**  
Gold - finitura lucida  
*Clear gold*



**44PV3VO**  
Verde acqua - finitura opaca  
*Frosted water green*

**I formati placche "Ave Touch"**  
*AVE Touch front plates size*

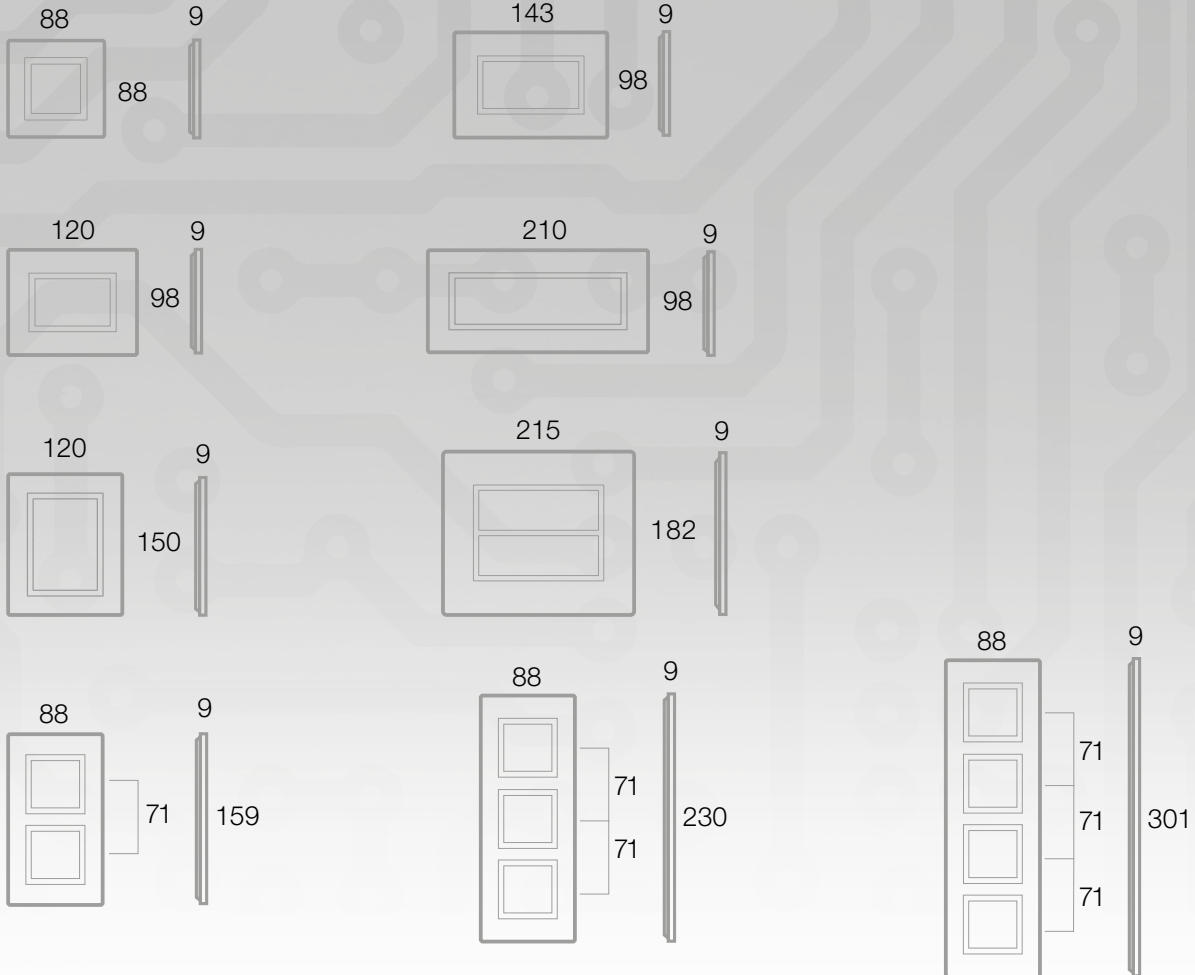

**Ring di finitura** *Finishing ring*

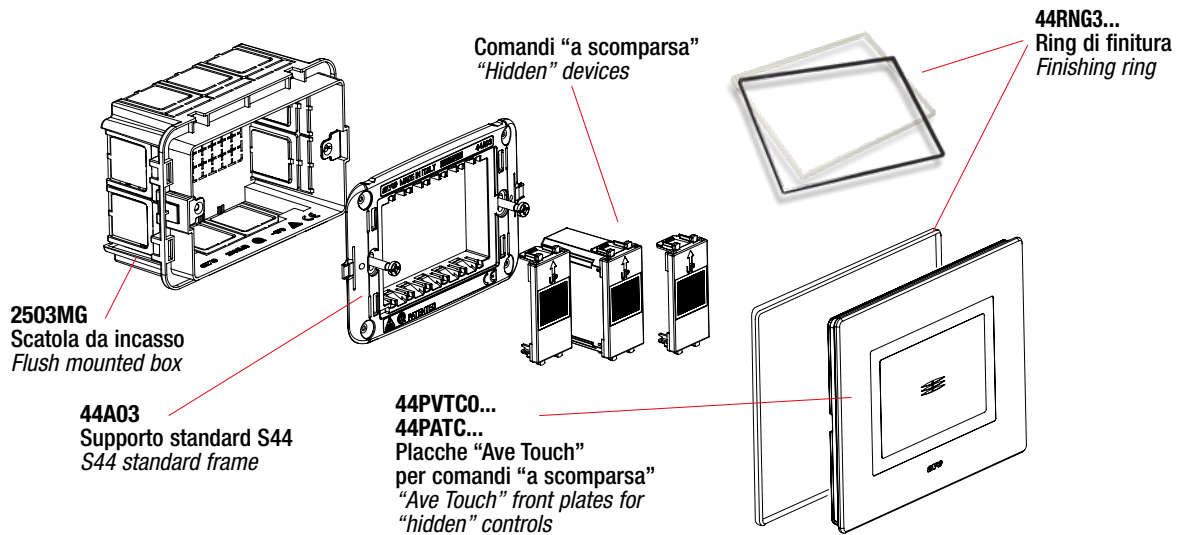





# Soluzioni AVE Touch

AVE Touch Solutions



Placche "Ave Touch" in vetro per scatola tonda o quadrata  
"Ave Touch" glass front plates for round or square box

164



BL



GO



GOLD



NAL



VO

Descrizione Description

Info

€

□

□

Per 1 comando "a scomparsa"  
For 1 "hidden" control

□ 44PVTG21BL	1	1
Bianco finitura lucida Clear white		
■ 44PVTG21GO	1	1
Grigio argentato finitura opaca Frosted silver grey		
■ 44PVTG21GOLD	1	1
Oro finitura lucida Clear gold		
■ 44PVTG21NAL	1	1
Nero assoluto finitura lucida Clear absolute black		
■ 44PVTG21VO	1	1
Verde acqua finitura opaca Frosted water green		

**Note:** ✓ complete di n° 2 tappi copriforo 442TC13R  
✓ assicurarsi che la placca sia perfettamente aderente agli apparecchi di comando "a scomparsa"

**Note:** ✓ supplied with 2 blank inserts 442TC13R  
✓ make sure that the front plate sticks perfectly to the "hidden" control devices

Supporto da utilizzare  
To be used with

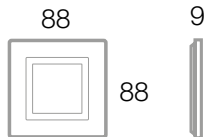

44A02  
44A02SG  
44A02VT

Scatole utilizzabili  
Available boxes



2501



2501P



2502



251CG

Pareti in muratura  
Brickwork walls

Pareti in cartongesso  
Hollow walls

Ring di finitura Finishing ring

Descrizione Description

Info

€

□

□



44RNG22B	2	50
Bianco Ral 9010 RAL 9010 white		
44RNG22N	2	50
Grigio scuro lucido Polished dark grey		



Per la disponibilità contattare la rete commerciale  
For availability please contact sales dept.



Disponibilità fino ad esaurimento scorte  
Available until stock out







Prodotto per scatola rettangolare inglese  
Product for British standard rectangular box



Prodotto per Export  
For Export only

Placche "Ave Touch" in vetro per scatola tonda o quadrata  
 "Ave Touch" glass front plates for round or square box

		Descrizione Description	Info	€	□	□
		<b>Per 2 comandi "a scomparsa"</b> For 2 "hidden" controls	□ 44PVTG22BL	1	1	
BL	GO		Bianco finitura lucida Clear white			
			■ 44PVTG22GO	1	1	
GOLD	NAL		Grigio argentato finitura opaca Frosted silver grey			
			■ 44PVTG22GOLD	1	1	
		Oro finitura lucida Clear gold				
		■ 44PVTG22NAL	1	1		
		Nero assoluto finitura lucida Clear absolute black				
		■ 44PVTG22VO	1	1		
		Verde acqua finitura opaca Frosted water green				
		<b>Nota:</b> assicurarsi che la placca sia perfettamente aderente agli apparecchi di comando "a scomparsa" <b>Note:</b> make sure that the front plate sticks perfectly to the "hidden" control devices				



Sistema 45

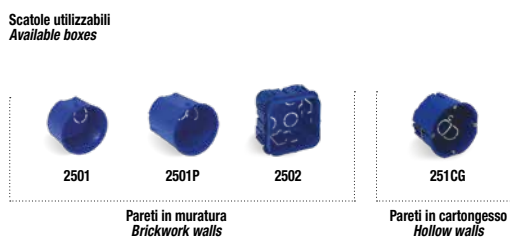
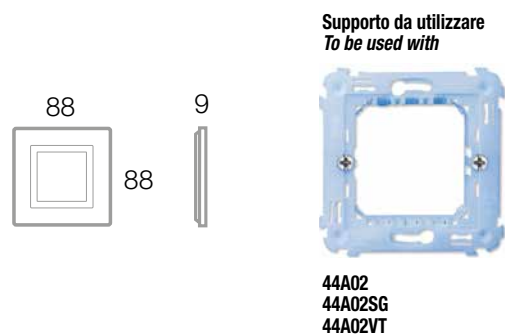

Ring di finitura Finishing ring		Descrizione Description	Info	€	□	□
		44RNG22B	2	50		
		Bianco Ral 9010 RAL 9010 white				
		44RNG22N	2	50		
		Grigio scuro lucido Polished dark grey				



# Soluzioni AVE Touch

AVE Touch Solutions



Placche "Ave Touch" in vetro per scatola 3 moduli (interasse 83,5 mm)  
"Ave Touch" glass front plates for rectangular 3 modules box (fixing centres 83,5 mm)

166



BL



GO

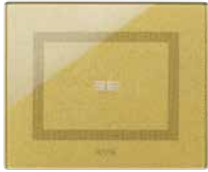

GOLD



NAL



VO

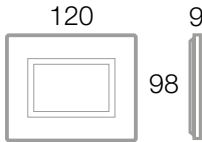

Descrizione Description

Info

€

□

□

Per 1 comando "a scomparsa"  
For 1 "hidden" control

□ 44PVTC01BL 1 1  
Bianco finitura lucida  
Clear white

■ 44PVTC01GO 1 1  
Grigio argentato finitura opaca  
Frosted silver grey

■ 44PVTC01GOLD 1 1  
Oro finitura lucida  
Clear gold

■ 44PVTC01NAL 1 1  
Nero assoluto finitura lucida  
Clear absolute black

■ 44PVTC01VO 1 1  
Verde acqua finitura opaca  
Frosted water green

Note: ✓ complete di n° 2 tappi copriforo 442TC13A  
✓ assicurarsi che la placca sia perfettamente aderente agli apparecchi di comando "a scomparsa"

Note: ✓ supplied with 2 blank inserts 442TC13A  
✓ make sure that the front plate sticks perfectly to the "hidden" control devices

Supporto da utilizzare  
To be used with



44A03

Scatole utilizzabili  
Available boxes



Pareti in muratura Brickwork walls



Pareti in cartongesso Hollow walls

Ring di finitura Finishing ring

Descrizione Description

Info

€

□

□



44RNG3B 2 50  
Bianco Ral 9010  
RAL 9010 white

44RNG3N 2 50  
Grigio scuro lucido  
Polished dark grey



Per la disponibilità contattare la rete commerciale  
For availability please contact sales dept.



Disponibilità fino ad esaurimento scorte  
Available until stock out



Prodotto per scatola rettangolare inglese  
Product for British standard rectangular box



Prodotto per Export  
For Export only

Placche "Ave Touch" in vetro per scatola 3 moduli (interasse 83,5 mm)  
 "Ave Touch" glass front plates for rectangular 3 modules box (fixing centres 83,5 mm)

Descrizione Description		Info	€	□	□
 		<b>Per 2 comandi "a scomparsa"</b> <i>For 2 "hidden" controls</i>			
<b>BL</b>	<b>GO</b>	<b>□ 44PVT02BL</b> Bianco finitura lucida <i>Clear white</i>	1	1	
		<b>■ 44PVT02GO</b> Grigio argentato finitura opaca <i>Frosted silver grey</i>	1	1	
		<b>■ 44PVT02GOLD</b> Oro finitura lucida <i>Clear gold</i>	1	1	
		<b>■ 44PVT02NAL</b> Nero assoluto finitura lucida <i>Clear absolute black</i>	1	1	
		<b>■ 44PVT02VO</b> Verde acqua finitura opaca <i>Frosted water green</i>	1	1	
		<b>Note:</b> ✓ complete di n° 1 tappo copriforo 442TC13A ✓ assicurarsi che la placca sia perfettamente aderente agli apparecchi di comando "a scomparsa" <b>Note:</b> ✓ supplied with 1 blank insert 442TC13A ✓ make sure that the front plate sticks perfectly to the "hidden" control devices			

VO

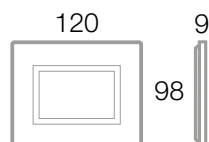

Supporto da utilizzare  
 To be used with



44A03

Scatole utilizzabili  
 Available boxes



Pareti in muratura Brickwork walls



Pareti in cartongesso Hollow walls

Ring di finitura Finishing ring		Descrizione Description	Info	€	□	□
		<b>44RNG3B</b> Bianco Ral 9010 <i>RAL 9010 white</i>	2	50		
		<b>44RNG3N</b> Grigio scuro lucido <i>Polished dark grey</i>	2	50		



# Soluzioni AVE Touch

AVE Touch Solutions



Placche "Ave Touch" in vetro per scatola 3 moduli (interasse 83,5 mm)  
"Ave Touch" glass front plates for rectangular 3 modules box (fixing centres 83,5 mm)

168



BL



GO

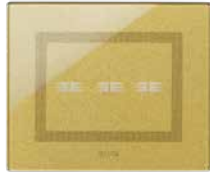

GOLD



NAL



VO

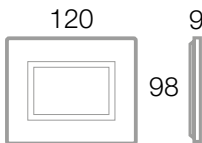

Descrizione Description

Info

€

□

□

Per 3 comandi "a scomparsa"  
For 3 "hidden" controls

□ 44PVT3BL 1 1

Bianco finitura lucida  
Clear white

■ 44PVT3GO 1 1

Grigio argentato finitura opaca  
Frosted silver grey

■ 44PVT3GOLD 1 1

Oro finitura lucida  
Clear gold

■ 44PVT3NAL 1 1

Nero assoluto finitura lucida  
Clear absolute black

■ 44PVT3VO 1 1

Verde acqua finitura opaca  
Frosted water green

Nota: assicurarsi che la placca sia perfettamente aderente agli apparecchi di comando "a scomparsa"

Note: make sure that the front plate sticks perfectly to the "hidden" control devices

Supporto da utilizzare  
To be used with



44A03

Scatole utilizzabili  
Available boxes



Pareti in muratura Brickwork walls



Pareti in cartongesso Hollow walls

Ring di finitura Finishing ring

Descrizione Description

Info

€

□

□



44RNG3B 2 50

Bianco Ral 9010  
RAL 9010 white

44RNG3N 2 50

Grigio scuro lucido  
Polished dark grey



Per la disponibilità contattare la rete commerciale  
For availability please contact sales dept.



Disponibilità fino ad esaurimento scorte  
Available until stock out



Prodotto per scatola rettangolare inglese  
Product for British standard rectangular box



Prodotto per Export  
For Export only

Placche "Ave Touch" in vetro per scatola 4 moduli (interasse 108,5 mm)  
 "Ave Touch" glass front plates for rectangular 4 modules box (fixing centres 108,5 mm)

Descrizione Description		Info	€	□	□
		<b>Per 3 comandi "a scomparsa"</b> For 3 "hidden" controls			
<b>BL</b>	<b>GO</b>	<b>□ 44PVT03BL</b> Bianco finitura lucida Clear white	a commessa upon request	1	1
		<b>■ 44PVT03GO</b> Grigio argentato finitura opaca Frosted silver grey	a commessa upon request	1	1
<b>NAL</b>	<b>VO</b>	<b>■ 44PVT03NAL</b> Nero assoluto finitura lucida Clear absolute black	a commessa upon request	1	1
		<b>■ 44PVT03VO</b> Verde acqua finitura opaca Frosted water green	a commessa upon request	1	1

**Note:** ✓ complete di n° 2 tappi copriforo 442TC13R  
 ✓ assicurarsi che la placca sia perfettamente aderente agli apparecchi di comando "a scomparsa"  
**Note:** ✓ supplied with 2 blank inserts 442TC13R  
 ✓ make sure that the front plate sticks perfectly to the "hidden" control devices

Supporto da utilizzare  
To be used with



44A04

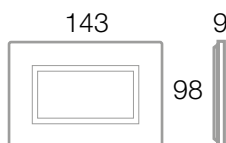

Scatole utilizzabili  
Available boxes



Pareti in muratura Brickwork walls



Pareti in cartongesso Hollow walls

Ring di finitura Finishing ring		Descrizione Description	Info	€	□	□
		<b>44RNG4B</b> Bianco Ral 9010 RAL 9010 white		2	50	
		<b>44RNG4N</b> Grigio scuro lucido Polished dark grey		2	50	



# Soluzioni AVE Touch

AVE Touch Solutions



Placche "Ave Touch" in vetro per scatola 4 moduli (interasse 108,5 mm)  
"Ave Touch" glass front plates for rectangular 4 modules box (fixing centres 108,5 mm)

170



BL



GO

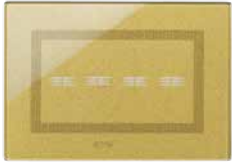

GOLD



NAL



VO

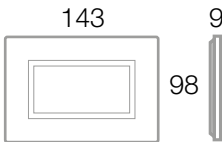

Descrizione Description Info € □ ▢

Per 4 comandi "a scomparsa"  
For 4 "hidden" controls

□ 44PVT4BL Bianco finitura lucida Clear white	1	1
■ 44PVT4GO Grigio argentato finitura opaca Frosted silver grey	1	1
■ 44PVT4GOLD Oro finitura lucida Clear gold	1	1
■ 44PVT4NAL Nero assoluto finitura lucida Clear absolute black	1	1
■ 44PVT4VO Verde acqua finitura opaca Frosted water green	1	1

Nota: assicurarsi che la placca sia perfettamente aderente agli apparecchi di comando "a scomparsa"

Note: make sure that the front plate sticks perfectly to the "hidden" control devices

Supporto da utilizzare  
To be used with



44A04

Scatole utilizzabili  
Available boxes



2504 253X4  
Pareti in muratura Brickwork walls



254CGPR 254CG 253X4CG  
Pareti in cartongesso Hollow walls

Ring di finitura Finishing ring Descrizione Description Info € □ ▢



44RNG4B Bianco Ral 9010 RAL 9010 white	2	50
44RNG4N Grigio scuro lucido Polished dark grey	2	50



Per la disponibilità contattare la rete commerciale  
For availability please contact sales dept.



Disponibilità fino ad esaurimento scorte  
Available until stock out







Prodotto per scatola rettangolare inglese  
Product for British standard rectangular box



Prodotto per Export  
For Export only



Placche "Ave Touch" in vetro per scatola 6-7 moduli (interasse 158,5 mm)  
 "Ave Touch" glass front plates for rectangular 6-7 modules box (fixing centres 158,5 mm)

	Descrizione <i>Description</i>	Info	€	<input type="checkbox"/>	<input type="checkbox"/>
	<b>Per 4 comandi "a scomparsa"</b> <i>For 4 "hidden" controls</i>				
	<input type="checkbox"/> <b>44PVT04BL</b> Bianco finitura lucida <i>Clear white</i>	a commessa <i>upon request</i>		1	1
	<input checked="" type="checkbox"/> <b>44PVT04GO</b> Grigio argentato finitura opaca <i>Frosted silver grey</i>	a commessa <i>upon request</i>		1	1
	<input checked="" type="checkbox"/> <b>44PVT04NAL</b> Nero assoluto finitura lucida <i>Clear absolute black</i>	a commessa <i>upon request</i>		1	1
	<input checked="" type="checkbox"/> <b>44PVT04VO</b> Verde acqua finitura opaca <i>Frosted water green</i>	a commessa <i>upon request</i>		1	1

**Note:** ✓ complete di n° 3 tappi copriforo 442TC13A  
 ✓ assicurarsi che la placca sia perfettamente aderente agli apparecchi di comando "a scomparsa"  
**Note:** ✓ *supplied with 3 blank inserts 442TC13A*  
 ✓ *make sure that the front plate sticks perfectly to the "hidden" control devices*

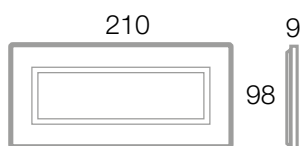

**Supporto da utilizzare**  
*To be used with*



**44A07**

**Scatole utilizzabili**  
*Available boxes*



**2506**  
 Pareti in muratura *Brickwork walls*



**256CG**  
 Pareti in cartongesso *Hollow walls*



# Soluzioni AVE Touch

AVE Touch Solutions



Placche "Ave Touch" in vetro per scatola 6-7 moduli (interasse 158,5 mm)

"Ave Touch" glass front plates for rectangular 6-7 modules box (fixing centres 158,5 mm)

172

Descrizione Description

Info

€

□

□



BL



GO



GOLD



NAL



VO

Per 7 comandi "a scomparsa"  
For 7 "hidden" controls

□ 44PVTC7BL	1	1
Bianco finitura lucida Clear white		
■ 44PVTC7GO	1	1
Grigio argentato finitura opaca Frosted silver grey		
■ 44PVTC7GOLD	1	1
Oro finitura lucida Clear gold		
■ 44PVTC7NAL	1	1
Nero assoluto finitura lucida Clear absolute black		
■ 44PVTC7VO	1	1
Verde acqua finitura opaca Frosted water green		

**Nota:** assicurarsi che la placca sia perfettamente aderente agli apparecchi di comando "a scomparsa"

**Note:** make sure that the front plate sticks perfectly to the "hidden" control devices

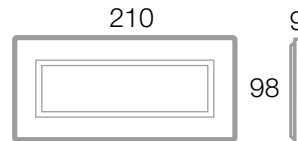

Supporto da utilizzare  
To be used with



44A07

Scatole utilizzabili  
Available boxes



Pareti in muratura Brickwork walls



Pareti in cartongesso Hollow walls



Per la disponibilità contattare la rete commerciale  
For availability please contact sales dept.



Disponibilità fino ad esaurimento scorte  
Available until stock out



Prodotto per scatola rettangolare inglese  
Product for British standard rectangular box



Prodotto per Export  
For Export only

Placche "Ave Touch" in vetro per scatola BL02P  
 "Ave Touch" glass front plates for BL02P box

		Descrizione <i>Description</i>	Info	€	<input type="checkbox"/>	<input type="checkbox"/>
		<b>Per 6 (3+3) comandi "a scomparsa"</b> <i>For 6 (3+3) "hidden" controls</i>				
<b>BL</b>	<b>GO</b>	<input type="checkbox"/> <b>44PVT33BL</b> Bianco finitura lucida <i>Clear white</i>	1	1		
		<input checked="" type="checkbox"/> <b>44PVT33GO</b> Grigio argentato finitura opaca <i>Frosted silver grey</i>	1	1		
		<input checked="" type="checkbox"/> <b>44PVT33NAL</b> Nero assoluto finitura lucida <i>Clear absolute black</i>	1	1		
		<input checked="" type="checkbox"/> <b>44PVT33VO</b> Verde acqua finitura opaca <i>Frosted water green</i>	1	1		
<b>NAL</b>	<b>VO</b>	<b>Nota:</b> assicurarsi che la placca sia perfettamente aderente agli apparecchi di comando "a scomparsa" <i>Note:</i> make sure that the front plate sticks perfectly to the "hidden" control devices				

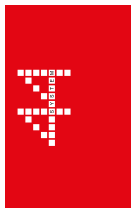

Sistema 45

Supporto da utilizzare  
*To be used with*

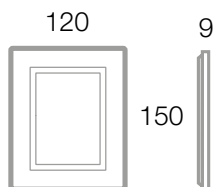

44A33

Scatole utilizzabili  
*Available boxes*





# Soluzioni AVE Touch

AVE Touch Solutions



Placche "Ave Touch" in vetro per scatola 3 moduli (interasse 83,5 mm)  
"Ave Touch" glass front plates for rectangular 3 modules box (fixing centres 83,5 mm)

174



BL



GO

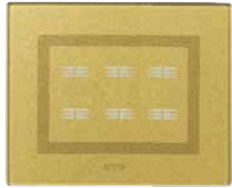

GOLD



NAL



VO

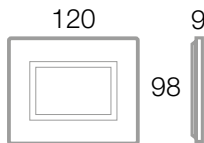

Scatole utilizzabili  
Available boxes



Pareti in muratura Brickwork walls



Pareti in cartongesso Hollow walls

Descrizione Description

Info

€

□

□

Per 6 (3+3) comandi "a scomparsa"  
For 6 (3+3) "hidden" controls

□ 44PVT16BL Bianco finitura lucida Clear white	1	1
■ 44PVT16GO Grigio argentato finitura opaca Frosted silver grey	1	1
■ 44PVT16GOLD Oro finitura lucida Clear gold	1	1
■ 44PVT16NAL Nero assoluto finitura lucida Clear absolute black	1	1
■ 44PVT16VO Verde acqua finitura opaca Frosted water green	1	1

Nota: assicurarsi che la placca sia perfettamente aderente agli apparecchi di comando "a scomparsa"

Note: make sure that the front plate sticks perfectly to the "hidden" control devices

Supporto da utilizzare  
To be used with



44A03

Ring di finitura Finishing ring

Descrizione Description

Info

€

□

□



44RNG3B Bianco Ral 9010 RAL 9010 white	2	50
44RNG3N Grigio scuro lucido Polished dark grey	2	50



Per la disponibilità contattare la rete commerciale  
For availability please contact sales dept.



Disponibilità fino ad esaurimento scorte  
Available until stock out



Prodotto per scatola rettangolare inglese  
Product for British standard rectangular box



Prodotto per Export  
For Export only

**Placche "Ave Touch" in vetro per scatola 3 moduli (interasse 83,5 mm)**  
**"Ave Touch" glass front plates for rectangular 3 modules box (fixing centres 83,5 mm)**

		Descrizione Description	Info	€	<input type="checkbox"/>	<input type="checkbox"/>
		<b>Per 1 modulo pulsante "a scomparsa" con targhetta portanome</b> <b>For 1 "hidden" push-button module with name tag</b> <input type="checkbox"/> <b>44PVT88BL</b> 1 1 Bianco finitura lucida <i>Clear white</i> <input checked="" type="checkbox"/> <b>44PVT88GO</b> 1 1 Grigio argentato finitura opaca <i>Frosted silver grey</i> <input checked="" type="checkbox"/> <b>44PVT88NAL</b> 1 1 Nero assoluto finitura lucida <i>Clear absolute black</i> <input checked="" type="checkbox"/> <b>44PVT88VO</b> 1 1 Verde acqua finitura opaca <i>Frosted water green</i>				
<b>BL</b>	<b>GO</b>					
						
<b>NAL</b>	<b>VO</b>					
<b>Nota: assicurarsi che la placca sia perfettamente aderente agli apparecchi di comando "a scomparsa"</b> <b>Note: make sure that the front plate sticks perfectly to the "hidden" control devices</b>						



Sistema 45

		Descrizione Description	Info	€	<input type="checkbox"/>	<input type="checkbox"/>
		<b>Per 1 modulo segnalazione luminosa/illuminazione "a scomparsa"</b> <b>For 1 "hidden" light/lighting signal module</b> <input type="checkbox"/> <b>44PVT76BL</b> 1 1 Bianco finitura lucida <i>Clear white</i> <input checked="" type="checkbox"/> <b>44PVT76GO</b> 1 1 Grigio argentato finitura opaca <i>Frosted silver grey</i> <input checked="" type="checkbox"/> <b>44PVT76NAL</b> 1 1 Nero assoluto finitura lucida <i>Clear absolute black</i> <input checked="" type="checkbox"/> <b>44PVT76VO</b> 1 1 Verde acqua finitura opaca <i>Frosted water green</i>				
<b>BL</b>	<b>GO</b>					
						
<b>NAL</b>	<b>VO</b>					
		<b>Supporto da utilizzare</b> <b>To be used with</b>  <b>44A03</b>				

Ring di finitura Finishing ring	Descrizione Description	Info	€	<input type="checkbox"/>	<input type="checkbox"/>
	<b>44RNG3B</b> Bianco Ral 9010 <i>RAL 9010 white</i>	2	50		
	<b>44RNG3N</b> Grigio scuro lucido <i>Polished dark grey</i>	2	50		

Le dimensioni, salvo diversamente specificato, sono in mm  
 Dimensions, except where otherwise specified, are in mm

Imballo Minimo pcs  
 Min. Packaging pcs

Imballo Standard pcs  
 Std. Packaging pcs



# Soluzioni AVE Touch

AVE Touch Solutions



Placche "Ave Touch" in vetro per scatola 3 moduli (interasse 83,5 mm)

"Ave Touch" glass front plates for rectangular 3 modules box (fixing centres 83,5 mm)

176

Descrizione Description

Info

€

□

□



BL



GO

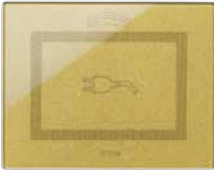

GOLD



NAL



VO

A scivolamento per copertura 3 mod. S44 - simbolo "spina"  
Sliding for covering 3 mod. S44 - "plug" symbol

□ 44PVTC3BL	1	1
Bianco finitura lucida Clear white		
■ 44PVTC3GO	1	1
Grigio argentato finitura opaca Frosted silver grey		
■ 44PVTC3GOLD	1	1
Oro finitura lucida Clear gold		
■ 44PVTC3NAL	1	1
Nero assoluto finitura lucida Clear absolute black		
■ 44PVTC3VO	1	1
Verde acqua finitura opaca Frosted water green		

**Note:** ✓ da utilizzare solo con supporti speciali 44ATC03B o 44ATC03GSL  
 ✓ simbolo spina illuminabile con inserto a led fornito in dotazione con il supporto  
 ✓ utilizzabile con tutti i prodotti 1, 2 o 3 moduli standard Sistema 44 ad esclusione dei codici a pag. 177

**Note:** ✓ to be used only with special frame 44ATC03B or 44ATC03GSL  
 ✓ "plug" symbol lightable by led supplied with the frame  
 ✓ it can be used with all the system 44 standard products 1-2 or 3 modules except for the codes on page 177

Supporti da utilizzare  
To be used with

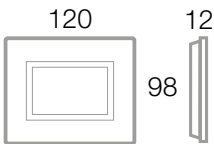

44ATC03ALS



44ATC03B



44ATC03GSL

## Esempio di utilizzo Application example



Scatole utilizzabili  
Available boxes



2503MG 253X4  
Pareti in muratura Brickwork walls



253CGPR 253CG 253X4CG  
Pareti in cartongesso Hollow walls



Per la disponibilità contattare la rete commerciale  
For availability please contact sales dept.



Disponibilità fino ad esaurimento scorte  
Available until stock out





Prodotto per scatola rettangolare inglese  
Product for British standard rectangular box



Prodotto per Export  
For Export only

**Placche "Ave Touch" in vetro per scatola 3 moduli (interasse 83,5 mm)**  
**"Ave Touch" glass front plates for rectangular 3 modules box (fixing centres 83,5 mm)**

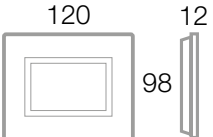
Descrizione Description		Info	€	□	□
		<b>A scivolamento per copertura 3 mod. S44</b> <i>Sliding for covering 3 mod. S44</i>			
<b>BL</b>	<b>GO</b>	<b>□ 44PVTGN3BL</b> Bianco finitura lucida <i>Clear white</i>	1	1	
		<b>■ 44PVTGN3GO</b> Grigio argentato finitura opaca <i>Frosted silver grey</i>	1	1	
<b>NAL</b>	<b>VO</b>	<b>■ 44PVTGN3NAL</b> Nero assoluto finitura lucida <i>Clear absolute black</i>	1	1	
		<b>■ 44PVTGN3VO</b> Verde acqua finitura opaca <i>Frosted water green</i>	1	1	
<p><b>Note:</b> ✓ da utilizzare solo con supporti speciali 44ATC03B o 44ATC03GSL          ✓ utilizzabile con tutti i prodotti 1, 2 o 3 moduli standard Sistema 44 ad esclusione dei codici riportati qui sotto.</p> <p><b>Note:</b> ✓ to be used only with special frame 44ATC03B or 44ATC03GSL          ✓ it can be used with all the system 44 standard products 1-2 or 3 modules except the codes here below.</p>					
					

Sistema 45

**Esempi di personalizzazione Customization examples**

# TUBO

Soluzioni per sistemi d'aspirazione centralizzata  
 Centralised vacuum system solutions



**AERTECNICA**  
think clean

Per informazioni commerciali contattare il numero verde **800 050816** oppure scrivere a: **info@aertecnica.com**

For any commercial information please call the toll-free number **800 050816** (valid only for domestic market) or send an email to: **info@aertecnica.com**

**Prodotti non installabili con placche "a Scivolamento" Products that can not be installed with sliding front plates**



**Prodotti non installabili con placche "a Scivolamento" in scatole per pareti cave Products that can not be installed with sliding front plates in boxes for hollow walls**

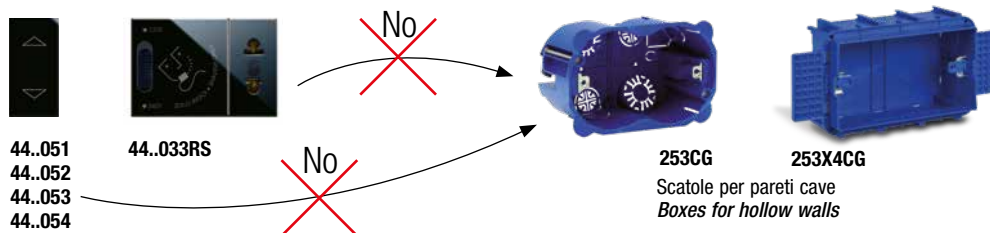

Le dimensioni, salvo diversamente specificato, sono in mm  
 Dimensions, except where otherwise specified, are in mm

□ Imballo Minimo pcs  
 Min. Packaging pcs

□ Imballo Standard pcs  
 Std. Packaging pcs



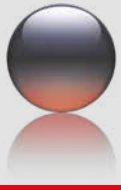

**Caratteristiche Tecniche** Technical Features

	<p><b>Scatole Boxes</b></p>	<p><b>Supporti accoppiabili</b> Frames that can be coupled</p> <p>n° 2 44A02 n° 2 44A02SG n° 2 44A02VT</p>
	<p><b>Standard Export</b></p> <p><b>Scatole Boxes</b></p> <p>2502      2501      2501P</p>	<p><b>Supporti accoppiabili</b> Frames that can be coupled</p> <p>n° 2 44A02 n° 2 44A02SG n° 2 44A02VT</p>
	<p><b>Standard Export</b></p> <p><b>Scatole Boxes</b></p> <p>2502      2501      2501P</p>	<p><b>Supporti accoppiabili</b> Frames that can be coupled</p> <p>n° 3 44A02 n° 3 44A02SG n° 3 44A02VT</p>
	<p><b>Scatole Boxes</b></p> <p>2502      2501      2501P</p>	<p><b>Supporti accoppiabili</b> Frames that can be coupled</p> <p>n° 4 44A02 n° 4 44A02SG n° 4 44A02VT</p>

**Vetro**  
Glass



Per la disponibilità contattare la rete commerciale  
For availability please contact sales dept.

Disponibilità fino ad esaurimento scorte  
Available until stock out

# Prodotto per scatola rettangolare inglese  
Product for British standard rectangular box

Prodotto per Export  
For Export only



Placche "Vera 44" per scatola tonda o quadrata  
"Vera 44" front plates for round or square box

Vetro Glass	Cod. Code	Colore Colour	Cornicetta Inner frame	Info	€	□	□
	44PV21BL	Bianco finitura lucida - 1 modulo <i>Clear white - 1 module</i>	Bianco Ral 9010 <i>Ral 9010 white</i>			1	1
	44PV21GO	Grigio argentato finitura opaca 1 modulo <i>Frosted silver grey - 1 module</i>	Grigio scuro lucido <i>Polished dark grey</i>			1	1
	44PV21GOLD	Oro finitura lucida - 1 modulo <i>Clear gold - 1 module</i>	Grigio scuro lucido <i>Polished dark grey</i>			1	1
	44PV21NAL	Nero assoluto finitura lucida 1 modulo <i>Clear absolute black - 1 module</i>	Cromo <i>Chrome</i>			1	1
	44PV21VO	Verde acqua finitura opaca 1 modulo <i>Frosted water green - 1 module</i>	Bianco Ral 9010 <i>Ral 9010 white</i>			1	1
	44PV22BL	Bianco finitura lucida - 2 moduli <i>Clear white - 2 modules</i>	Bianco Ral 9010 <i>Ral 9010 white</i>			1	1
	44PV22GO	Grigio argentato finitura opaca 2 moduli <i>Frosted silver grey - 2 modules</i>	Grigio scuro lucido <i>Polished dark grey</i>			1	1
	44PV22GOLD	Oro finitura lucida - 2 moduli <i>Clear gold - 2 modules</i>	Grigio scuro lucido <i>Polished dark grey</i>			1	1
	44PV22NAL	Nero assoluto finitura lucida 2 moduli <i>Clear absolute black - 2 modules</i>	Cromo <i>Chrome</i>			1	1
	44PV22VO	Verde acqua finitura opaca 2 moduli <i>Frosted water green - 2 modules</i>	Bianco Ral 9010 <i>Ral 9010 white</i>			1	1

179

Sistema 45

Cornicette di ricambio Spare inner frames

	Cod. Code	Colore Colour	Info	€	□	□
	44CRV21B	Bianco Ral 9010 <i>Ral 9010 white</i>			2	50
	44CRV21N	Grigio scuro lucido <i>Polished dark grey</i>			2	50
	44CRV21CR	Cromo <i>Chrome</i>			2	50
	44CRV22B	Bianco Ral 9010 <i>Ral 9010 white</i>			2	50
	44CRV22N	Grigio scuro lucido <i>Polished dark grey</i>			2	50
	44CRV22CR	Cromo <i>Chrome</i>			2	50

Ring di finitura Finishing ring

	Cod. Code	Colore Colour	Info	€	□	□
	44RNG22B	Bianco Ral 9010 <i>Ral 9010 white</i>			2	50
	44RNG22N	Grigio scuro lucido <i>Polished dark grey</i>			2	50

Le dimensioni, salvo diversamente specificato, sono in mm  
Dimensions, except where otherwise specified, are in mm

 Imballo Minimo pcs  
Min. Packaging pcs

 Imballo Standard pcs  
Std. Packaging pcs



# Placche





## Front Plates



### Placche "Vera 44" per scatola tonda o quadrata

#### "Vera 44" front plates for round or square box

180

Vetro Glass	Cod. Code	Colore Colour	Cornicetta Inner frame	Info	€	□	□
	44PV24BL	Bianco finitura lucida 2+2 moduli <i>Clear white - 2+2 modules</i>	Bianco Ral 9010 <i>Ral 9010 white</i>			1	1
	44PV24GO	Grigio argentato finitura opaca 2+2 moduli <i>Frosted silver grey - 2+2 modules</i>	Grigio scuro lucido <i>Polished dark grey</i>			1	1
	44PV24GOLD	Oro finitura lucida - 2+2 moduli <i>Clear gold</i>	Grigio scuro lucido <i>Polished dark grey</i>			1	1
	44PV24NAL	Nero assoluto finitura lucida 2+2 moduli <i>Clear absolute black - 2+2 modules</i>	Cromo <i>Chrome</i>			1	1
	44PV24VO	Verde acqua finitura opaca 2+2 moduli <i>Frosted water green - 2+2 modules</i>	Bianco Ral 9010 <i>Ral 9010 white</i>			1	1
	44PV26BL	Bianco finitura lucida 2+2+2 moduli <i>Clear white - 2+2+2 modules</i>	Bianco Ral 9010 <i>Ral 9010 white</i>			1	1
	44PV26GO	Grigio argentato finitura opaca 2+2+2 moduli <i>Frosted silver grey - 2+2+2 modules</i>	Grigio scuro lucido <i>Polished dark grey</i>			1	1
	44PV26GOLD	Oro finitura lucida - 2+2+2 moduli <i>Clear gold</i>	Grigio scuro lucido <i>Polished dark grey</i>			1	1
	44PV26NAL	Nero assoluto finitura lucida 2+2+2 moduli <i>Clear absolute black - 2+2+2 modules</i>	Cromo <i>Chrome</i>			1	1
	44PV26VO	Verde acqua finitura opaca 2+2+2 moduli <i>Frosted water green - 2+2+2 modules</i>	Bianco Ral 9010 <i>Ral 9010 white</i>			1	1
	44PV28BL	Bianco finitura lucida 2+2+2+2 moduli <i>Clear white - 2+2+2+2 modules</i>	Bianco Ral 9010 <i>Ral 9010 white</i>			6	6
	44PV28GO	Grigio argentato finitura opaca 2+2+2 moduli <i>Frosted silver grey - 2+2+2 modules</i>	Grigio scuro lucido <i>Polished dark grey</i>			6	6
	44PV28GOLD	Oro finitura lucida 2+2+2+2 moduli <i>Clear gold - 2+2+2+2 modules</i>	Grigio scuro lucido <i>Polished dark grey</i>			6	6
	44PV28NAL	Nero assoluto finitura lucida 2+2+2+2 moduli <i>Clear absolute black - 2+2+2+2 modules</i>	Cromo <i>Chrome</i>			6	6
	44PV28VO	Verde acqua finitura opaca 2+2+2+2 moduli <i>Frosted water green - 2+2+2+2 modules</i>	Bianco Ral 9010 <i>Ral 9010 white</i>			6	6

### Cornicette di ricambio Spare inner frames

Cod. Code	Colore Colour	Info	€	□	□
44CRV22B	Bianco Ral 9010 <i>Ral 9010 white</i>			2	50
44CRV22N	Grigio scuro lucido <i>Polished dark grey</i>			2	50
44CRV22CR	Cromo <i>Chrome</i>			2	50



Per la disponibilità contattare la rete commerciale  
For availability please contact sales dept.



Disponibilità fino ad esaurimento scorte  
Available until stock out



Prodotto per scatola rettangolare inglese  
Product for British standard rectangular box



Prodotto per Export  
For Export only

## Placche "Vera 44" per scatola rettangolare

"Vera 44" front plates for rectangular box

3 MODULI 3 MODULES	Cod. Code	Colore Colour	Cornicetta Inner frame	Info	€	<input type="checkbox"/>	<input type="checkbox"/>
	<b>Vetro Glass</b>						
	44PV3BL	Bianco finitura lucida <i>Clear white</i>	Bianco Ral 9010 <i>Ral 9010 white</i>	1	1		
	44PV3G0	Grigio argentato finitura opaca <i>Frosted silver grey</i>	Grigio scuro lucido <i>Polished dark grey</i>	1	1		
	44PV3GOLD	Oro finitura lucida <i>Clear gold</i>	Grigio scuro lucido <i>Polished dark grey</i>	1	1		
	44PV3NAL	Nero assoluto finitura lucida <i>Clear absolute black</i>	Cromo <i>Chrome</i>	1	1		
44PV3VO	Verde acqua finitura opaca <i>Frosted water green</i>	Bianco Ral 9010 <i>Ral 9010 white</i>	1	1			

181

Sistema 45

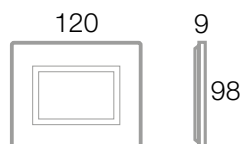

Supporto da utilizzare  
To be used with



44A03

### Cornicette di ricambio Spare inner frames

	Cod. Code	Colore Colour	Info	€	<input type="checkbox"/>	<input type="checkbox"/>
	44CRV3B	Bianco Ral 9010 <i>Ral 9010 white</i>	2	50		
	44CRV3N	Grigio scuro lucido <i>Polished dark grey</i>	2	50		
	44CRV3CR	Cromo <i>Chrome</i>	2	50		

### Ring di finitura Finishing ring

	Cod. Code	Colore Colour	Info	€	<input type="checkbox"/>	<input type="checkbox"/>
	44RNG3B	Bianco Ral 9010 <i>Ral 9010 white</i>	2	50		
	44RNG3N	Grigio scuro lucido <i>Polished dark grey</i>	2	50		

Le dimensioni, salvo diversamente specificato, sono in mm  
Dimensions, except where otherwise specified, are in mm

Imballo Minimo pcs  
Min. Packaging pcs

Imballo Standard pcs  
Std. Packaging pcs



# Placche



## Front Plates



### Placche "Vera 44" per scatola rettangolare

#### "Vera 44" front plates for rectangular box

182

VETRO GLASS	Cod. Code	Colore Colour	Cornicetta Inner frame	Info	€	□	□
  143 9 98	44PV4BL	Bianco finitura lucida 4 moduli <i>Clear white - 4 modules</i>	Bianco Ral 9010 <i>Ral 9010 white</i>			1	1
	44PV4GO	Grigio argentato finitura opaca 4 moduli <i>Frosted silver grey - 4 modules</i>	Grigio scuro lucido <i>Polished dark grey</i>			1	1
	44PV4GOLD	Oro finitura lucida - 4 moduli 4 moduli <i>Clear gold - 4 modules</i>	Grigio scuro lucido <i>Polished dark grey</i>			1	1
	44PV4NAL	Nero assoluto finitura lucida 4 moduli <i>Clear absolute black - 4 modules</i>	Cromo <i>Chrome</i>			1	1
  210 9 98	44PV4VO	Verde acqua finitura opaca 4 moduli <i>Frosted water green - 4 modules</i>	Bianco Ral 9010 <i>Ral 9010 white</i>			1	1
	44PV7BL	Bianco finitura lucida 7 moduli <i>Clear white - 7 modules</i>	Bianco Ral 9010 <i>Ral 9010 white</i>			1	1
	44PV7GO	Grigio argentato finitura opaca 7 moduli <i>Frosted silver grey - 7 modules</i>	Grigio scuro lucido <i>Polished dark grey</i>			1	1
	44PV7GOLD	Oro finitura lucida 7 moduli <i>Clear gold - 7 modules</i>	Grigio scuro lucido <i>Polished dark grey</i>			1	1
	44PV7NAL	Nero assoluto finitura lucida 7 moduli <i>Clear absolute black - 7 modules</i>	Cromo <i>Chrome</i>			1	1
	44PV7VO	Verde acqua finitura opaca 7 moduli <i>Frosted water green - 7 modules</i>	Bianco Ral 9010 <i>Ral 9010 white</i>			1	1

Supporti da utilizzare  
To be used with





44A04

Supporti da utilizzare  
To be used with



44A07

### Cornicette di ricambio Spare inner frames

	Cod. Code	Colore Colour	Info	€	□	□
	44CRV4B	Bianco Ral 9010 <i>Ral 9010 white</i>			2	50
	44CRV4N	Grigio scuro lucido <i>Polished dark grey</i>			2	50
	44CRV4CR	Cromo <i>Chrome</i>			2	50
	44CRV7B	Bianco Ral 9010 <i>Ral 9010 white</i>			2	30
	44CRV7N	Grigio scuro lucido <i>Polished dark grey</i>			2	30
	44CRV7CR	Cromo <i>Chrome</i>			2	30

### Ring di finitura Finishing ring

	Cod. Code	Colore Colour	Info	€	□	□
	44RNG4B	Bianco Ral 9010 <i>Ral 9010 white</i>			2	50
	44RNG4N	Grigio scuro lucido <i>Polished dark grey</i>			2	50



Per la disponibilità contattare  
la rete commerciale  
For availability please contact  
sales dept.



Disponibilità fino ad  
esaurimento scorte  
Available until stock out



Prodotto per scatola  
rettangolare inglese  
Product for British standard  
rectangular box



Prodotto  
per Export  
For Export  
only

## Placche "Vera 44" per scatola BL02P "Vera 44" front plates for BL02P box

6(3+3) MODULI 6(3+3) MODULES	Cod. Code	Colore Colour	Cornicetta Inner frame	Info	€	□	□
	44PV33BL	Bianco finitura lucida Clear white	Bianco Ral 9010 Ral 9010 white			1	1
	44PV33GO	Grigio argentato finitura opaca Frosted silver grey	Grigio scuro lucido Polished dark grey			1	1
	44PV33NAL	Nero assoluto finitura lucida Clear absolute black	Cromo Chrome			1	1

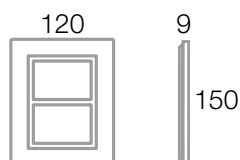

Supporto da utilizzare  
To be used with  
44A12

44A33

Scatola da utilizzare  
To be used with



BL02P

Pareti in muratura  
Brickwork walls



BL02CG

Pareti in cartongesso  
Hollow walls

Prodotti Installabili  
Product to be installed



TS01

Touch Screen  
4,3"



44.AP01

Diffusore acustico  
Loudspeaker

## Cornicette di ricambio Spare inner frames

	Cod. Code	Colore Colour	Info	€	□	□
	44CRV33B	Bianco Ral 9010 Ral 9010 white			2	50
	44CRV33CR	Cromo Chrome			2	50
	44CRV33CR/AP	Cromo - versione senza traversino centrale da utilizzare con diffusori sonori 441AP01 o 442AP01 Chrome - version without central cross bar to be used with 441AP01 or 442AP01 loudspeakers			2	50

## Placche "Vera 44" per scatola BL05P e BL05CG "Vera 44" front plates for BL05P and BL05CG boxes

12(6+6) MODULI 12(6+6) MODULES	Cod. Code	Colore Colour	Info	€	□	□
	44PV12BL	Bianco finitura lucida Clear white	Bianco Ral 9010 Ral 9010 white			1 1
	44PV12NAL	Nero assoluto finitura lucida Clear absolute black	Cromo Chrome			1 1

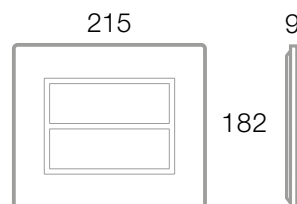

Supporto da utilizzare  
To be used with



44A12

Le dimensioni, salvo diversamente specificato, sono in mm  
Dimensions, except where otherwise specified, are in mm

□ Imballo Minimo pcs  
Min. Packaging pcs

□ Imballo Standard pcs  
Std. Packaging pcs



# Placche

## Front Plates

184

**I colori delle placche "Ave Touch" e VERA 44 ALLUMINIO**  
*AVE Touch and Vera 44 Aluminium front plates colours*

**Design:**  
 L. Merletti



**44PATC3ALS**  
 Alluminio naturale spazzolato  
*Natural brushed aluminium*



**44PATC3ANS**  
 Alluminio antracite spazzolato  
*Anthracite brushed aluminium*

### ALLUMINIO ALUMINIUM



**44PA3ALS**  
 Alluminio naturale spazzolato  
*Natural brushed aluminium*



**44PA3ANS**  
 Alluminio antracite spazzolato  
*Anthracite brushed aluminium*

### Ring di finitura Finishing ring

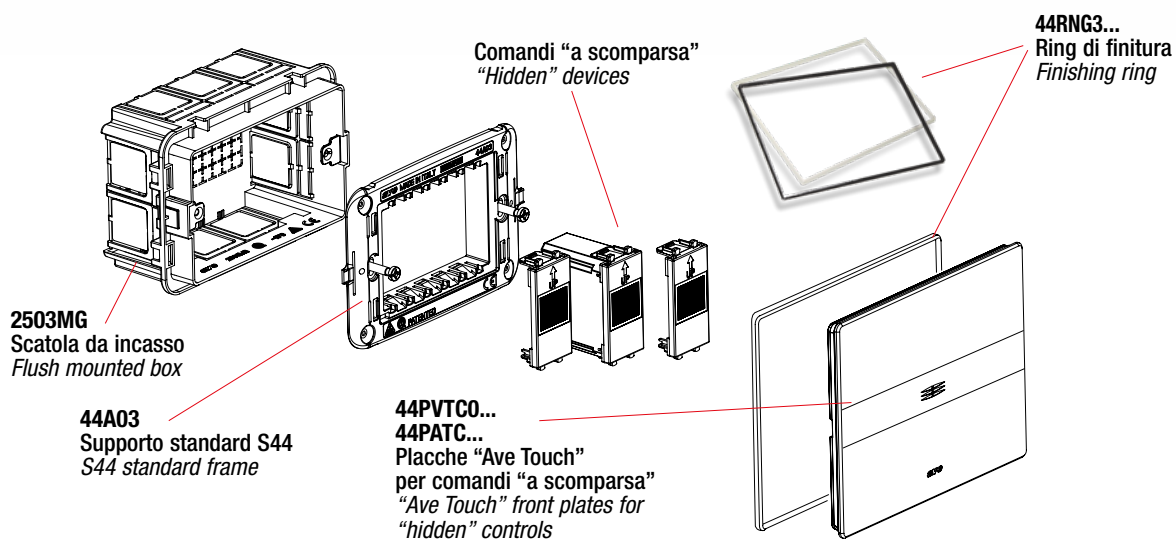



**I formati placche "Ave Touch" ALLUMINIO**  
*AVE Touch Aluminium front plates size*

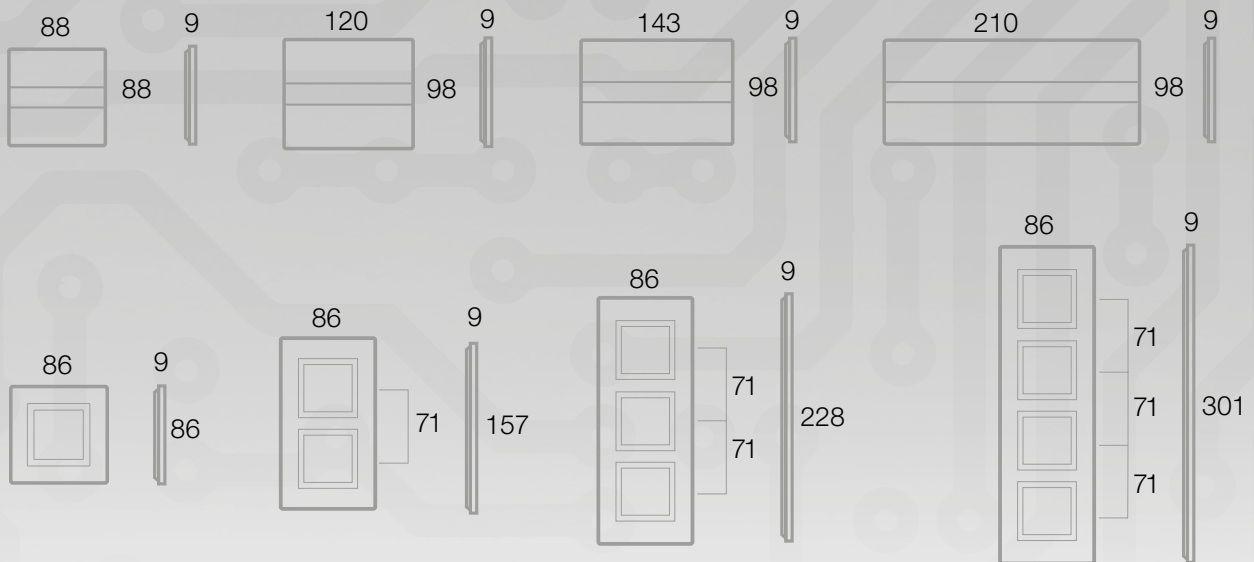

**I formati placche VERA 44 ALLUMINIO**  
*VERA 44 Aluminium front plates size*

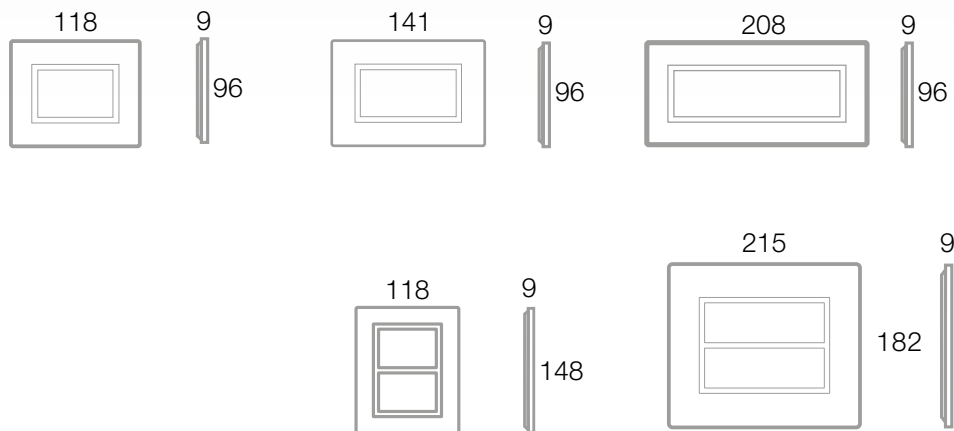



# Soluzioni AVE Touch

AVE Touch Solutions



Placche "Ave Touch" in alluminio per scatola tonda o quadrata  
"Ave Touch" aluminium front plates for round or square box

186



ALS



ANS

Descrizione Description

Info

€

□

□

Fino a 2 comandi "a scomparsa"  
Up to 2 "hidden" controls

■ 44PATC22ALS	1	1
Alluminio naturale spazzolato Natural brushed aluminium		
■ 44PATC22ANS	1	1
Alluminio antracite spazzolato Anthracite brushed aluminium		

**Nota:** assicurarsi che la placca sia perfettamente aderente agli apparecchi di comando "a scomparsa"

**Note:** make sure that the front plate sticks perfectly to the "hidden" control devices

Supporto da utilizzare  
To be used with

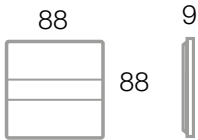

44A02  
44A02SG  
44A02VT

Scatole utilizzabili  
Available boxes



Pareti in muratura  
Brickwork walls

Pareti in cartongesso  
Hollow walls

Ring di finitura Finishing ring

Descrizione Description

Info

€

□

□



44RNG22B	2	50
Bianco Ral 9010 RAL 9010 white		
44RNG22N	2	50
Grigio scuro lucido Polished dark grey		



Per la disponibilità contattare la rete commerciale  
For availability please contact sales dept.



Disponibilità fino ad esaurimento scorte  
Available until stock out





Prodotto per scatola rettangolare inglese  
Product for British standard rectangular box



Prodotto per Export  
For Export only

**Placche "Ave Touch" in alluminio per scatola 3 moduli (interasse 83,5 mm)**  
**"Ave Touch" aluminium front plates for 3 modules box (fixing centres 83,5 mm)**

	Descrizione <i>Description</i>	Info	€	□	□
 <b>ALS</b>	<b>Fino a 3 comandi "a scomparsa"</b> <i>Up to 3 "hidden" controls</i>				
	<b>44PATC3ALS</b> Alluminio naturale spazzolato <i>Natural brushed aluminium</i>	1	1		
 <b>ANS</b>	<b>44PATC3ANS</b> Alluminio antracite spazzolato <i>Anthracite brushed aluminium</i>	1	1		
	<b>Nota:</b> assicurarsi che la placca sia perfettamente aderente agli apparecchi di comando "a scomparsa" <b>Note:</b> make sure that the front plate sticks perfectly to the "hidden" control devices				

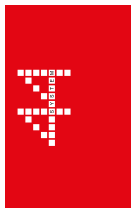

Sistema 45

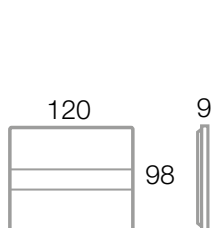

**Supporto da utilizzare**  
*To be used with*



**44A03**

**Scatole utilizzabili**  
*Available boxes*



**Pareti in muratura** *Brickwork walls*



**Pareti in cartongesso** *Hollow walls*

Ring di finitura <i>Finishing ring</i>	Descrizione <i>Description</i>	Info	€	□	□
	<b>44RNG3B</b> Bianco Ral 9010 <i>RAL 9010 white</i>	2	50		
	<b>44RNG3N</b> Grigio scuro lucido <i>Polished dark grey</i>	2	50		

Le dimensioni, salvo diversamente specificato, sono in mm  
 Dimensions, except where otherwise specified, are in mm

□ Imballo Minimo pcs  
 Min. Packaging pcs

□ Imballo Standard pcs  
 Std. Packaging pcs



# Soluzioni AVE Touch

AVE Touch Solutions



Placche "Ave Touch" in alluminio per scatola 4 moduli (interasse 108,5 mm)  
"Ave Touch" aluminium front plates for 4 modules box (fixing centres 108,5 mm)

188



ALS



ANS

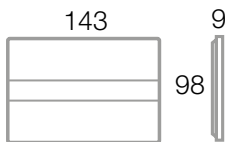

Descrizione Description

Info

€

□

□

Fino a 4 comandi "a scomparsa"  
Up to 4 "hidden" controls

■ 44PATC4ALS 1 1  
Alluminio naturale spazzolato  
Natural brushed aluminium

■ 44PATC4ANS 1 1  
Alluminio antracite spazzolato  
Anthracite brushed aluminium

Nota: assicurarsi che la placca sia perfettamente aderente agli apparecchi di comando "a scomparsa"

Note: make sure that the front plate sticks perfectly to the "hidden" control devices

Supporto da utilizzare  
To be used with



44A04

Scatole utilizzabili  
Available boxes

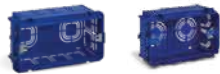

2504 253X4

Pareti in muratura Brickwork walls



254CGPR 254CG 253X4CG

Pareti in cartongesso Hollow walls

Ring di finitura Finishing ring

Descrizione Description

Info

€

□

□



44RNG4B 2 50  
Bianco Ral 9010  
RAL 9010 white

44RNG4N 2 50  
Grigio scuro lucido  
Polished dark grey



Per la disponibilità contattare la rete commerciale  
For availability please contact sales dept.



Disponibilità fino ad esaurimento scorte  
Available until stock out





Prodotto per scatola rettangolare inglese  
Product for British standard rectangular box



Prodotto per Export  
For Export only

Placche "Ave Touch" in alluminio per scatola 6-7 moduli (interasse 158,5 mm)  
 "Ave Touch" aluminium front plates for 6-7 modules box (fixing centres 158,5 mm)

	Descrizione Description	Info	€	□	□	189
 <b>ALS</b>	<b>Fino a 7 comandi "a scomparsa"</b> <i>Up to 7 "hidden" controls</i>					
	<b>■ 44PATC7ALS</b>	Alluminio naturale spazzolato <i>Natural brushed aluminium</i>	1	1		
 <b>ANS</b>						
	<b>■ 44PATC7ANS</b>	Alluminio antracite spazzolato <i>Anthracite brushed aluminium</i>	1	1		
<p><b>Nota:</b> assicurarsi che la placca sia perfettamente aderente agli apparecchi di comando "a scomparsa"  <i>Note: make sure that the front plate sticks perfectly to the "hidden" control devices</i></p>						



Sistema 45

Supporto da utilizzare  
 To be used with

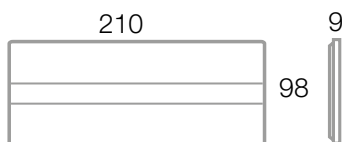

44A07

Scatole utilizzabili  
 Available boxes



Pareti in muratura *Brickwork walls*



Pareti in cartongesso *Hollow walls*



# Soluzioni AVE Touch

AVE Touch Solutions



Placche "Ave Touch" in alluminio per scatola 3 moduli (interasse 83,5 mm)  
"Ave Touch" aluminium front plates for 3 modules box (fixing centres 83,5 mm)

190

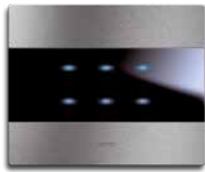

ALS



ANS

Descrizione Description

Info

€

□

□

Fino a 6 (3+3) comandi "a scomparsa"  
Up to 6 (3+3) "hidden" controls

■ 44PATC16ALS	1	1
Alluminio naturale spazzolato Natural brushed aluminium		
■ 44PATC16ANS	1	1
Alluminio antracite spazzolato Anthracite brushed aluminium		

**Nota:** assicurarsi che la placca sia perfettamente aderente agli apparecchi di comando "a scomparsa"

**Note:** make sure that the front plate sticks perfectly to the "hidden" control devices

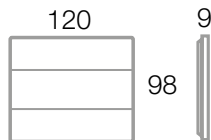

Supporto da utilizzare  
To be used with



44A03

Scatole utilizzabili  
Available boxes



Pareti in muratura Brickwork walls



Pareti in cartongesso Hollow walls

Ring di finitura Finishing ring

Descrizione Description

Info

€

□

□



44RNG3B	2	50
Bianco Ral 9010 RAL 9010 white		
44RNG3N	2	50
Grigio scuro lucido Polished dark grey		



Per la disponibilità contattare la rete commerciale  
For availability please contact sales dept.



Disponibilità fino ad esaurimento scorte  
Available until stock out





Prodotto per scatola rettangolare inglese  
Product for British standard rectangular box



Prodotto per Export  
For Export only

**Placche "Ave Touch" in alluminio per scatola 3 moduli (interasse 83,5 mm)**  
**"Ave Touch" aluminium front plates for 3 modules box (fixing centres 83,5 mm)**

	Descrizione <i>Description</i>	Info	€	<input type="checkbox"/>	<input type="checkbox"/>
 <b>ALS</b>	<b>Per 1 modulo pulsante "a scomparsa" con targhetta portanome</b> <b>For 1 "hidden" push-button module with name tag</b>				
	<b>44PATC88ALS</b> Alluminio naturale spazzolato <i>Natural brushed aluminium</i>	1	1		
 <b>ANS</b>	<b>44PATC88ANS</b> Alluminio antracite spazzolato <i>Anthracite brushed aluminium</i>	1	1		
	<b>Nota: assicurarsi che la placca sia perfettamente aderente agli apparecchi di comando "a scomparsa"</b> <b>Note: make sure that the front plate sticks perfectly to the "hidden" control devices</b>				

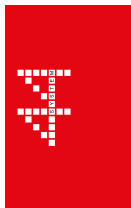

Sistema 45

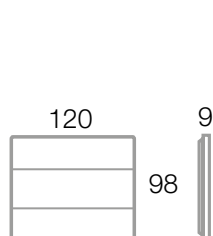

**Supporto da utilizzare**  
**To be used with**



**44A03**

**Scatole utilizzabili**  
**Available boxes**



**Pareti in muratura** *Brickwork walls*



**Pareti in cartongesso** *Hollow walls*

Ring di finitura <i>Finishing ring</i>	Descrizione <i>Description</i>	Info	€	<input type="checkbox"/>	<input type="checkbox"/>
	<b>44RNG3B</b> Bianco Ral 9010 <i>RAL 9010 white</i>	2	50		
	<b>44RNG3N</b> Grigio scuro lucido <i>Polished dark grey</i>	2	50		

Le dimensioni, salvo diversamente specificato, sono in mm  
 Dimensions, except where otherwise specified, are in mm

Imballo Minimo pcs  
 Min. Packaging pcs

Imballo Standard pcs  
 Std. Packaging pcs





# Soluzioni AVE Touch

AVE Touch Solutions



Placche "Ave Touch" in alluminio per scatola 3 moduli (interasse 83,5 mm)  
"Ave Touch" aluminium front plates for 3 modules box (fixing centres 83,5 mm)

192

Descrizione Description

Info

€

□

□



ALS



ANS

A scivolamento per copertura 3 mod. S44 - simbolo "spina"  
Sliding for covering 3 mod. S44 - "plug" symbol

■ 44PATCS3ALS	1	1
Alluminio naturale spazzolato Natural brushed aluminium		
■ 44PATCS3ANS	1	1
Alluminio antracite spazzolato Anthracite brushed aluminium		

**Note:** ✓ da utilizzare solo con supporti speciali 44ATC03ALS o 44ATC03GSL  
✓ simbolo spina illuminabile con inserto a led fornito in dotazione con l'appoggio  
✓ utilizzabile con tutti i prodotti 1, 2 o 3 moduli standard Sistema 44 ad esclusione dei codici a pag. 177

**Note:** ✓ to be used only with special frame 44ATC03ALS or 44ATC03GSL  
✓ "plug" symbol lightable by led supplied with the frame  
✓ it can be used with all the system 44 standard products 1-2 or 3 modules except for the codes on page 177

Supporti da utilizzare  
To be used with



44ATC03ALS



44ATC03GSL

Scatole utilizzabili  
Available boxes



Pareti in muratura Brickwork walls



Pareti in cartongesso Hollow walls

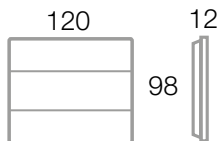

Esempio di utilizzo Application example



Per la disponibilità contattare la rete commerciale  
For availability please contact sales dept.



Disponibilità fino ad esaurimento scorte  
Available until stock out





Prodotto per scatola rettangolare inglese  
Product for British standard rectangular box



Prodotto per Export  
For Export only

Placche "Ave Touch" in alluminio per scatola 3 moduli (interasse 83,5 mm)  
 "Ave Touch" aluminium front plates for 3 modules box (fixing centres 83,5 mm)

	Descrizione <i>Description</i>	Info	€	□	□
	<b>A scivolamento per copertura 3 moduli S44</b> <i>Sliding for covering 3 modules S44</i>	■ <b>44PATCN3ALS</b>		1	1
ALS		Alluminio naturale spazzolato <i>Natural brushed aluminium</i>			
		■ <b>44PATCN3ANS</b>		1	1
ANS		Alluminio antracite spazzolato <i>Anthracite brushed aluminium</i>			
<b>Note:</b> ✓ da utilizzare solo con supporti speciali 44ATC03ALS o 44ATC03GSL ✓ utilizzabile con tutti i prodotti 1, 2 o 3 moduli standard Sistema 44 ad esclusione dei codici a pag. 103 <b>Note:</b> ✓ <i>to be used only with special frame 44ATC03ALS or 44ATC03GSL</i> ✓ <i>it can be used with all the system 44 standard products 1-2 or 3 modules except for the codes on page 103</i>					



Sistema 45

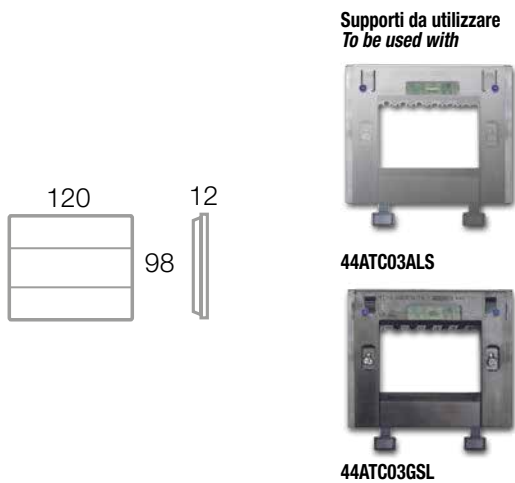

**Esempio di utilizzo** *Application example*





# Soluzioni AVE Touch

AVE Touch Solutions



Placche "Ave Touch" in alluminio per scatola 3 moduli (interasse 83,5 mm)  
"Ave Touch" aluminium front plates for 3 modules box (fixing centres 83,5 mm)

194



ALS



ANS

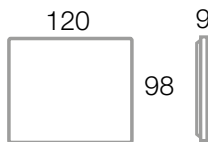

Descrizione Description

Info

€

□

□

Comando facilitato per diversamente abili - personalizzabile  
Easier control for disabled - customizable

■ 44PATC3ALS/DA 1 1

Alluminio naturale spazzolato  
Natural brushed aluminium

■ 44PATC3ANS/DA 1 1

Alluminio antracite spazzolato  
Anthracite brushed aluminium

**Nota:** assicurarsi che la placca sia perfettamente aderente agli apparecchi di comando "a scomparsa"

**Note:** make sure that the front plate sticks perfectly to the "hidden" control devices

Supporto da utilizzare  
To be used with



44A03

Scatole utilizzabili  
Available boxes



Pareti in muratura Brickwork walls



Pareti in cartongesso Hollow walls

Ring di finitura Finishing ring

Descrizione Description

Info

€

□

□



44RNG3B 2 50

Bianco Ral 9010  
RAL 9010 white

44RNG3N 2 50

Grigio scuro lucido  
Polished dark grey



Per la disponibilità contattare la rete commerciale  
For availability please contact sales dept.



Disponibilità fino ad esaurimento scorte  
Available until stock out



Prodotto per scatola rettangolare inglese  
Product for British standard rectangular box



Prodotto per Export  
For Export only

Placche "Ave Touch" in alluminio per scatola 3 moduli (interasse 83,5 mm)  
 "Ave Touch" aluminium front plates for 3 modules box (fixing centres 83,5 mm)



ALS



ANS

Descrizione Description

Info

€

□

□

**3 moduli standard S44 - anche per installazioni "filo muro"**  
**3 modules standard for S44 - also for "wall-lined" installations**

■ 44PA3ALS/FM	1	1
Alluminio naturale spazzolato Natural brushed aluminium		
■ 44PA3ANS/FM	1	1
Alluminio antracite spazzolato Anthracite brushed aluminium		

**Nota:** se le placche vengono utilizzate con i lettori di camera del sistema alberghiero (codd. 44..GA01-M e 44..GA30-M) è necessario richiedere una placca "speciale".  
**Note:** If the front plate is used with room readers of hotel management system (code 44..GA01-M or 44..GA30-M) is necessary to order the "special" front plate.  
 For more information contact our area manager.

Supporto da utilizzare  
 To be used with



44A03

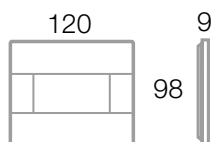

Scatole utilizzabili  
 Available boxes



Pareti in muratura Brickwork walls



Pareti in cartongesso Hollow walls

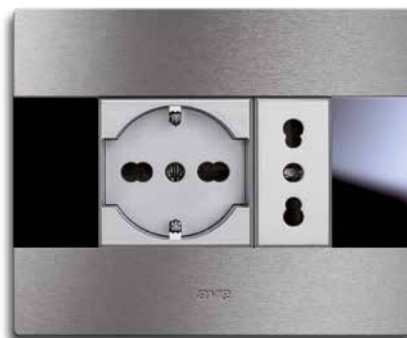

Ring di finitura Finishing ring

Descrizione Description

Info

€

□

□



44RNG3B	2	50
Bianco Ral 9010 RAL 9010 white		
44RNG3N	2	50
Grigio scuro lucido Polished dark grey		



# Soluzioni AVE Touch

AVE Touch Solutions



Placche "Ave Touch" in alluminio per scatola 4 moduli (interasse 108,5 mm)  
"Ave Touch" aluminium front plates for 4 modules box (fixing centres 108,5 mm)

196



ALS



ANS

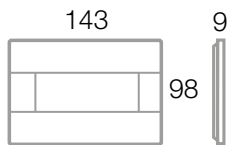

Descrizione Description

Info

€

□

□

4 moduli standard S44  
4 modules standard for S44

■ 44PA4ALS/FM	1	1
Alluminio naturale spazzolato Natural brushed aluminium		
■ 44PA4ANS/FM	1	1
Alluminio antracite spazzolato Anthracite brushed aluminium		

Supporto da utilizzare  
To be used with



44A04

Scatole utilizzabili  
Available boxes



Pareti in muratura Brickwork walls



Pareti in cartongesso Hollow walls

Ring di finitura Finishing ring

Descrizione Description

Info

€

□

□



44RNG4B	2	50
Bianco Ral 9010 RAL 9010 white		
44RNG4N	2	50
Grigio scuro lucido Polished dark grey		



Per la disponibilità contattare la rete commerciale  
For availability please contact sales dept.



Disponibilità fino ad esaurimento scorte  
Available until stock out



Prodotto per scatola rettangolare inglese  
Product for British standard rectangular box



Prodotto per Export  
For Export only

**Placche "Ave Touch" in alluminio per scatola 6-7 moduli (interasse 158,5 mm)**  
**"Ave Touch" aluminium front plates for 6-7 modules box (fixing centres 158,5 mm)**

	Descrizione <i>Description</i>	Info	€	<input type="checkbox"/>	<input type="checkbox"/>	197
 <b>ALS</b>	<b>7 moduli standard S44</b> <i>7 modules standard for S44</i>					
	■ <b>44PA7ALS/FM</b> Alluminio naturale spazzolato <i>Natural brushed aluminium</i>	1	1			
 <b>ANS</b>	■ <b>44PA7ANS/FM</b> Alluminio antracite spazzolato <i>Anthracite brushed aluminium</i>	1	1			

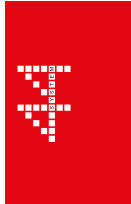

Sistema 45

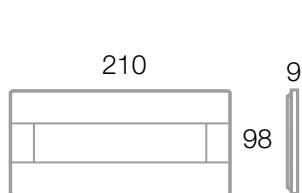

**Supporto da utilizzare**  
*To be used with*



**44A07**

**Scatole utilizzabili**  
*Available boxes*



**Esempio di utilizzo** *Application example*



Le dimensioni, salvo diversamente specificato, sono in mm  
 Dimensions, except where otherwise specified, are in mm

Imballo Minimo pcs  
 Min. Packaging pcs

Imballo Standard pcs  
 Std. Packaging pcs



**Caratteristiche Tecniche** Technical Features

	<p><b>Scatole Boxes</b></p>	<p><b>Supporti accoppiabili</b> Frames that can be coupled</p> <p>n° 2 44A02 n° 2 44A02SG n° 2 44A02VT</p>
	<p><b>Scatole Boxes</b></p> <p>Standard Export    2502    2501    2501P</p>	<p><b>Supporti accoppiabili</b> Frames that can be coupled</p> <p>n° 2 44A02 n° 2 44A02SG n° 2 44A02VT</p>
	<p><b>Scatole Boxes</b></p> <p>Standard Export    2502    2501    2501P</p>	<p><b>Supporti accoppiabili</b> Frames that can be coupled</p> <p>n° 3 44A02 n° 3 44A02SG n° 3 44A02VT</p>
	<p><b>Scatole Boxes</b></p> <p>2502    2501    2501P</p>	<p><b>Supporti accoppiabili</b> Frames that can be coupled</p> <p>n° 4 44A02 n° 4 44A02SG n° 4 44A02VT</p>

Per la disponibilità contattare la rete commerciale  
For availability please contact sales dept.

Disponibilità fino ad esaurimento scorte  
Available until stock out

# Prodotto per scatola rettangolare inglese  
Product for British standard rectangular box

Prodotto per Export  
For Export only



Placche "Vera 44" per scatola tonda o quadrata  
"Vera 44" front plates for round or square box

1 MODULO 1 MODULE	Cod. Code	Colore Colour	Cornicetta Inner frame	Info	€	<input type="checkbox"/>	<input type="checkbox"/>
-------------------	-----------	---------------	------------------------	------	---	--------------------------	--------------------------



Alluminio Aluminium

44PA21ALS	Alluminio naturale spazzolato Natural brushed aluminium	Cromo Chrome	1	1
44PA21ANS	Alluminio antracite spazzolato Anthracite brushed aluminium	Cromo Chrome	1	1

2 MODULI 2 MODULES	Cod. Code	Colore Colour	Cornicetta Inner frame	Info	€	<input type="checkbox"/>	<input type="checkbox"/>
--------------------	-----------	---------------	------------------------	------	---	--------------------------	--------------------------



Alluminio Aluminium

44PA22ALS	Alluminio naturale spazzolato Natural brushed aluminium	Cromo Chrome	1	1
44PA22ANS	Alluminio antracite spazzolato Anthracite brushed aluminium	Cromo Chrome	1	1

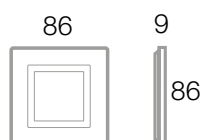

Alluminio e Legno  
Aluminium and Wood



Supporto da utilizzare  
To be used with

44A02  
44A02SG  
44A02VT

Cornicette di ricambio Spare inner frames

Cod. Code	Colore Colour	Info	€	<input type="checkbox"/>	<input type="checkbox"/>
-----------	---------------	------	---	--------------------------	--------------------------



44CRV21B	Bianco Ral 9010 Ral 9010 white	2	50
44CRV21N	Grigio scuro lucido Polished dark grey	2	50
44CRV21CR	Cromo Chrome	2	50
44CRV22B	Bianco Ral 9010 Ral 9010 white	2	50
44CRV22N	Grigio scuro lucido Polished dark grey	2	50
44CRV22CR	Cromo Chrome	2	50

Ring di finitura Finishing ring

Cod. Code	Colore Colour	Info	€	<input type="checkbox"/>	<input type="checkbox"/>
-----------	---------------	------	---	--------------------------	--------------------------



44RNG22B	Bianco Ral 9010 Ral 9010 white	2	50
44RNG22N	Grigio scuro lucido Polished dark grey	2	50



# Placche

## Front Plates



### Placche "Vera 44" per scatola tonda o quadrata

### "Vera 44" front plates for round or square box

200

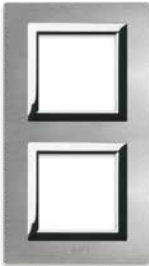
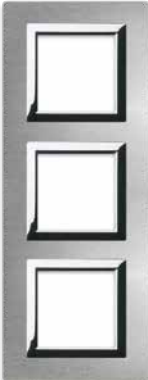
Alluminio	Aluminium	Cod. Code	Colore Colour	Cornicetta Inner frame	Info	€	□	□
		<b>44PA24ALS</b>	Alluminio naturale spazzolato 2+2 moduli <i>Natural brushed aluminium - 2+2 modules</i>	Cromo <i>Chrome</i>			1	1
		<b>44PA24ANS</b>	Alluminio antracite spazzolato 2+2 moduli <i>Anthracite brushed aluminium - 2+2 modules</i>	Cromo <i>Chrome</i>			1	1
		<b>44PA26ALS</b>	Alluminio naturale spazzolato 2+2+2 moduli <i>Natural brushed aluminium - 2+2+2 modules</i>	Cromo <i>Chrome</i>			1	1
		<b>44PA26ANS</b>	Alluminio antracite spazzolato 2+2+2 moduli <i>Anthracite brushed aluminium - 2+2+2 modules</i>	Cromo <i>Chrome</i>			1	1
		<b>44PA28ALS</b>	Alluminio naturale spazzolato 2+2+2+2 moduli <i>Natural brushed aluminium- 2+2+2+2 modules</i>	Cromo <i>Chrome</i>			6	6
		<b>44PA28ANS</b>	Alluminio antracite spazzolato 2+2+2+2 moduli <i>Anthracite brushed aluminium 2+2+2+2 modules</i>	Cromo <i>Chrome</i>			6	6



Supporto da utilizzare  
To be used with

44A02  
44A02SG  
44A02VT

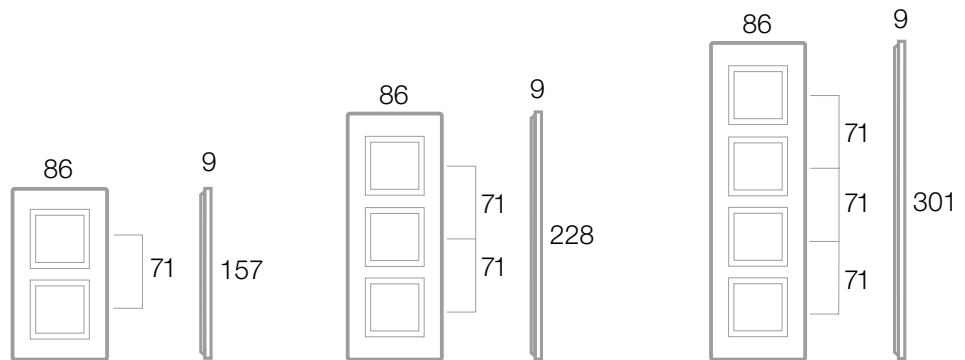

### Cornicette di ricambio Spare inner frames



Cod. Code	Colore Colour	Info	€	□	□
<b>44CRV22B</b>	Bianco Ral 9010 <i>Ral 9010 white</i>			2	50
<b>44CRV22N</b>	Grigio scuro lucido <i>Polished dark grey</i>			2	50
<b>44CRV22CR</b>	Cromo <i>Chrome</i>			2	50



Per la disponibilità contattare la rete commerciale  
For availability please contact sales dept.



Disponibilità fino ad esaurimento scorte  
Available until stock out



Prodotto per scatola rettangolare inglese  
Product for British standard rectangular box



Prodotto per Export  
For Export only

## Placche "Vera 44" per scatola rettangolare

"Vera 44" front plates for rectangular box

Alluminio Aluminium	Cod. Code	Colore Colour	Cornicetta Inner frame	Info	€	□	□
	44PA3ALS	Alluminio naturale spazzolato 3 moduli <i>Natural brushed aluminium 3 modules</i>	Cromo <i>Chrome</i>	1	1		
	44PA3ANS	Alluminio antracite spazzolato 3 moduli <i>Anthracite brushed aluminium 3 modules</i>	Cromo <i>Chrome</i>	1	1		

201

Sistema 45



Alluminio e Legno  
Aluminium and Wood

Supporto da utilizzare  
To be used with



44A03

## Cornicette di ricambio Spare inner frames

	Cod. Code	Colore Colour	Info	€	□	□
	44CRV3B	Bianco Ral 9010 <i>Ral 9010 white</i>	2	50		
	44CRV3N	Grigio scuro lucido <i>Polished dark grey</i>	2	50		
	44CRV3CR	Cromo <i>Chrome</i>	2	50		

## Ring di finitura Finishing ring

	Cod. Code	Colore Colour	Info	€	□	□
	44RNG3B	Bianco Ral 9010 <i>Ral 9010 white</i>	2	50		
	44RNG3N	Grigio scuro lucido <i>Polished dark grey</i>	2	50		



# Placche



## Front Plates



### Placche "Vera 44" per scatola rettangolare

#### "Vera 44" front plates for rectangular box

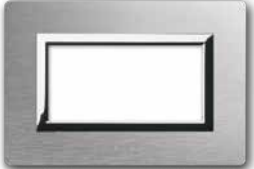
202

Alluminio Aluminium	Cod. Code	Colore Colour	Cornicetta Inner frame	Info	€	□	□
  141 9 96	44PA4ALS	Alluminio naturale spazzolato 4 moduli <i>Natural brushed aluminium 4 modules</i>	Cromo <i>Chrome</i>	1	1		
	44PA4ANS	Alluminio antracite spazzolato 4 moduli <i>Anthracite brushed aluminium 4 modules</i>	Cromo <i>Chrome</i>	1	1		
	44PA7ALS	Alluminio naturale spazzolato 7 moduli <i>Natural brushed aluminium 7 modules</i>	Cromo <i>Chrome</i>	1	1		
	44PA7ANS	Alluminio antracite spazzolato 7 moduli <i>Anthracite brushed aluminium 7 modules</i>	Cromo <i>Chrome</i>	1	1		

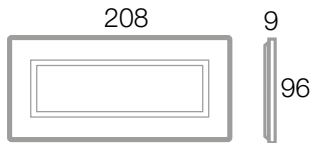

Supporti da utilizzare  
*To be used with*



44A04

Supporti da utilizzare  
*To be used with*



44A07

### Cornicette di ricambio Spare inner frames

	Cod. Code	Colore Colour	Info	€	□	□
	44CRV4B	Bianco Ral 9010 <i>Ral 9010 white</i>		2	50	
	44CRV4N	Grigio scuro lucido <i>Polished dark grey</i>		2	50	
	44CRV4CR	Cromo <i>Chrome</i>		2	50	
	44CRV7B	Bianco Ral 9010 <i>Ral 9010 white</i>		2	30	
	44CRV7N	Grigio scuro lucido <i>Polished dark grey</i>		2	30	
	44CRV7CR	Cromo <i>Chrome</i>		2	30	

### Ring di finitura Finishing ring

	Cod. Code	Colore Colour	Info	€	□	□
	44RNG4B	Bianco Ral 9010 <i>Ral 9010 white</i>		2	50	
	44RNG4N	Grigio scuro lucido <i>Polished dark grey</i>		2	50	



Per la disponibilità contattare la rete commerciale  
For availability please contact sales dept.



Disponibilità fino ad esaurimento scorte  
Available until stock out



Prodotto per scatola rettangolare inglese  
Product for British standard rectangular box



Prodotto per Export  
For Export only

## Placche "Vera 44" per scatola BL02P

"Vera 44" front plates for BL02P box

6(3+3) MODULI 6(3+3) MODULES	Cod. Code	Colore Colour	Cornicetta Inner frame	Info	€	<input type="checkbox"/>	<input type="checkbox"/>
	44PA33ALS	Alluminio naturale spazzolato Natural brushed aluminium	Cromo Chrome			1	1
	44PA33ANS	Alluminio antracite spazzolato Anthracite brushed aluminium	Cromo Chrome			1	1

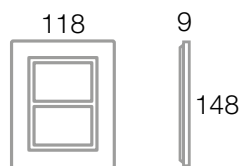

Alluminio e Legno  
Aluminium and Wood

Supporto da utilizzare  
To be used with



44A33

Scatola da utilizzare  
To be used with



BL02P  
Pareti in muratura  
Brickwork walls



BL02CG  
Pareti in cartongesso  
Hollow walls

Prodotti Installabili  
Product to be installed



TS01  
Touch Screen  
4,3"



44.AP01  
Diffusore acustico  
Loudspeaker

203

Sistema 45

## Placche "Vera 44" per scatola BL05P e BL05CG

"Vera 44" front plates for BL05P and BL05CG boxes

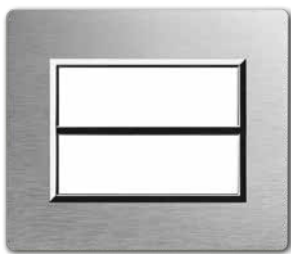
12(6+6) MODULI 12(6+6) MODULES	Cod. Code	Colore Colour	Cornicetta Inner frame	Info	€	<input type="checkbox"/>	<input type="checkbox"/>
	44PA12ALS	Alluminio naturale spazzolato Natural brushed aluminium	Cromo Chrome			1	1
	44PA12ANS	Alluminio antracite spazzolato Anthracite brushed aluminium	Cromo Chrome			1	1

Supporto da utilizzare  
To be used with  
44A12

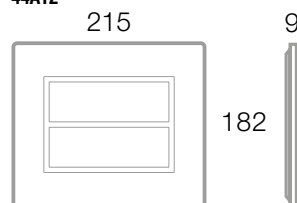

Supporto da utilizzare  
To be used with



44A12

## Cornicette di ricambio Spare inner frames

	Cod. Code	Colore Colour	Info	€	<input type="checkbox"/>	<input type="checkbox"/>
	44CRV33B	Bianco Ral 9010 Ral 9010 white			2	50
	44CRV33CR	Cromo Chrome			2	50
	44CRV33CR/AP	Cromo - versione senza traversino centrale da utilizzare con diffusori sonori 441AP01 o 442AP01 Chrome - version without central cross bar to be used with 441AP01 or 442AP01 loudspeakers			2	50

Le dimensioni, salvo diversamente specificato, sono in mm  
Dimensions, except where otherwise specified, are in mm

Imballo Minimo pcs  
Min. Packaging pcs

Imballo Standard pcs  
Std. Packaging pcs

# Placche

## Front Plates

204

I colori delle placche VERA 44 LEGNO e CORIAN®  
VERA 44 Wood and CORIAN® front plates colours

### LEGNO MASSELLO WOOD



**44PL3RS**  
Rovere sbiancato  
*Whitened oak*



**44PL3WG**  
Wengé  
*Wenge*

### CORIAN®



**44PCN3B**  
Bianco  
*White*

**I formati placche VERA 44 LEGNO e CORIAN®**  
**VERA 44 Wood and CORIAN® front plates size**

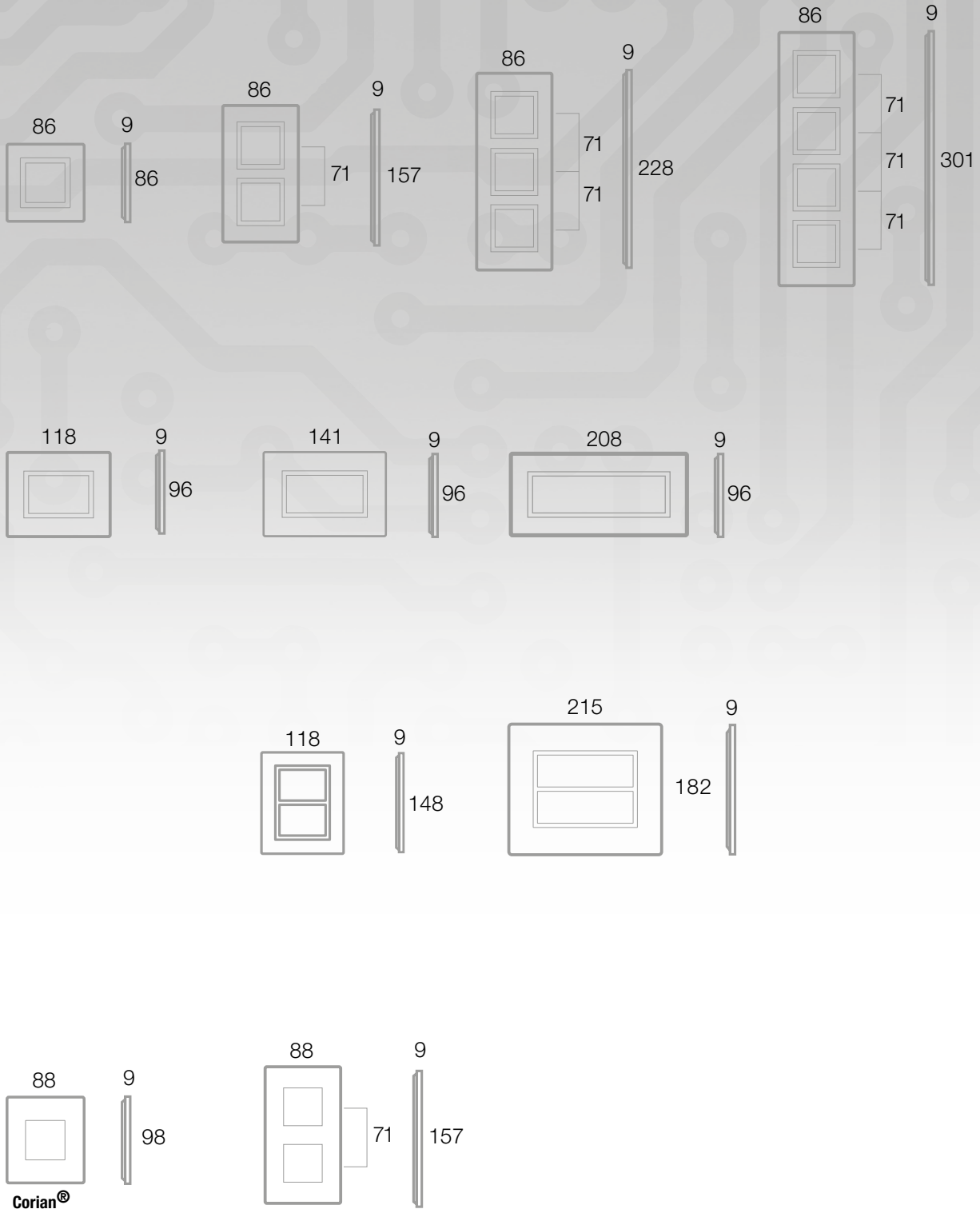





# Placche

## Front Plates



Placche "Vera 44" per scatola tonda o quadrata  
"Vera 44" front plates for round or square box

206

1 MODULO	1 MODULE	Cod. Code	Colore Colour	Cornicetta Inner frame	Info	€	□	□
----------	----------	-----------	---------------	------------------------	------	---	---	---



### Legno massello Wood

44PL21RS	Rovere sbiancato Whitened oak	Cromo Chrome	1	1
44PL21WG	Wengé Wenge	Grigio scuro lucido Polished dark grey	1	1
44PL22RS	Rovere sbiancato Whitened oak	Cromo Chrome	1	1
44PL22WG	Wengé Wenge	Grigio scuro lucido Polished dark grey	1	1



### Corian®

44PCT22B	Bianco White	-	1	1
----------	-----------------	---	---	---

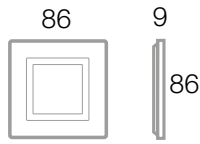

Alluminio e Legno  
Aluminium and Wood

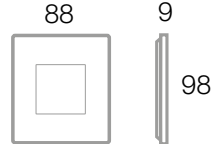

Corian®



44A02  
44A02SG  
44A02VT

Supporto da utilizzare  
To be used with

### Cornicette di ricambio Spare inner frames

Cod. Code	Colore Colour	Info	€	□	□
-----------	---------------	------	---	---	---



44CRV21B	Bianco Ral 9010 Ral 9010 white	2	50
44CRV21N	Grigio scuro lucido Polished dark grey	2	50
44CRV21CR	Cromo Chrome	2	50
44CRV22B	Bianco Ral 9010 Ral 9010 white	2	50
44CRV22N	Grigio scuro lucido Polished dark grey	2	50
44CRV22CR	Cromo Chrome	2	50



### Ring di finitura Finishing ring

Cod. Code	Colore Colour	Info	€	□	□
-----------	---------------	------	---	---	---



44RNG22B	Bianco Ral 9010 Ral 9010 white	2	50
44RNG22N	Grigio scuro lucido Polished dark grey	2	50



Per la disponibilità contattare  
la rete commerciale  
For availability please contact  
sales dept.



Disponibilità fino ad  
esaurimento scorte  
Available until stock out



Prodotto per scatola  
rettangolare inglese  
Product for British standard  
rectangular box



Prodotto  
per Export  
For Export  
only

Placche "Vera 44" per scatola tonda o quadrata  
"Vera 44" front plates for round or square box

4(2+2) MODULI 4(2+2) MODULES	Cod. Code	Colore Colour	Cornicetta Inner frame	Info	€	□	□
------------------------------	-----------	---------------	------------------------	------	---	---	---

207



**Legno massello Wood**

44PL24RS	Rovere sbiancato Whitened oak	Cromo Chrome	1	1
44PL24WG	Wengé Wenge	Grigio scuro lucido Polished dark grey	1	1

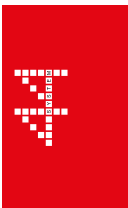

Sistema 45



**Corian®**

44PCT24B	Bianco White	-	1	1
----------	-----------------	---	---	---

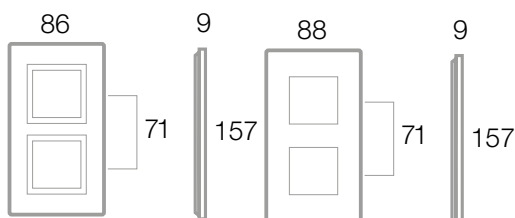

Alluminio e Legno  
Aluminium and Wood

Corian®

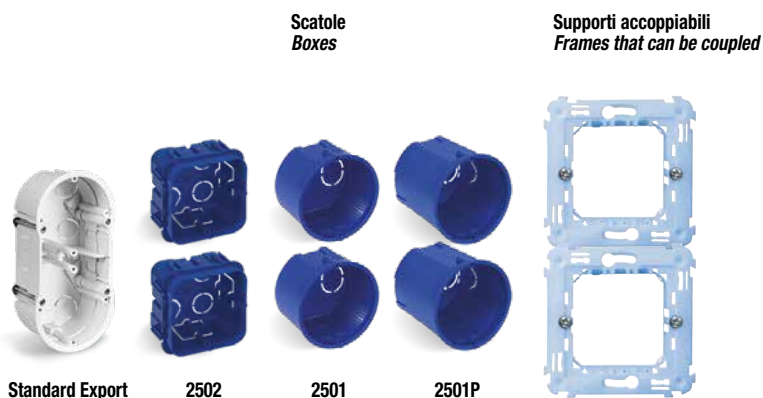

**Cornicette di ricambio Spare inner frames**

Cod. Code	Colore Colour	Info	€	□	□
-----------	---------------	------	---	---	---



44CRV22B	Bianco Ral 9010 Ral 9010 white	2	50
44CRV22N	Grigio scuro lucido Polished dark grey	2	50
44CRV22CR	Cromo Chrome	2	50

Le dimensioni, salvo diversamente specificato, sono in mm  
Dimensions, except where otherwise specified, are in mm

□ Imballo Minimo pcs  
Min. Packaging pcs

□ Imballo Standard pcs  
Std. Packaging pcs



# Placche

## Front Plates



Placche "Vera 44" per scatola tonda o quadrata  
"Vera 44" front plates for round or square box

208

6(2+2+2) MODULI 6(2+2+2) MODULES Cod. Code Colore Colour Cornicetta Inner frame Info € □ □



### Legno massello Wood

44PL26RS	Rovere sbiancato Whitened oak	Cromo Chrome	1	1
44PL26WG	Wengé Wenge	Grigio scuro lucido Polished dark grey	1	1



### Corian®

44PCT26B	Bianco White	-	1	1
----------	-----------------	---	---	---

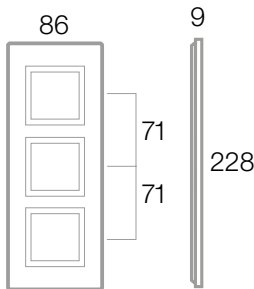

Alluminio e Legno  
Aluminium and Wood

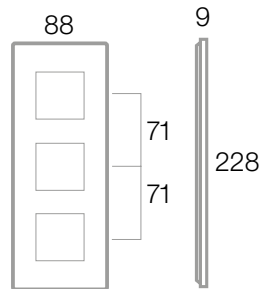

Corian®

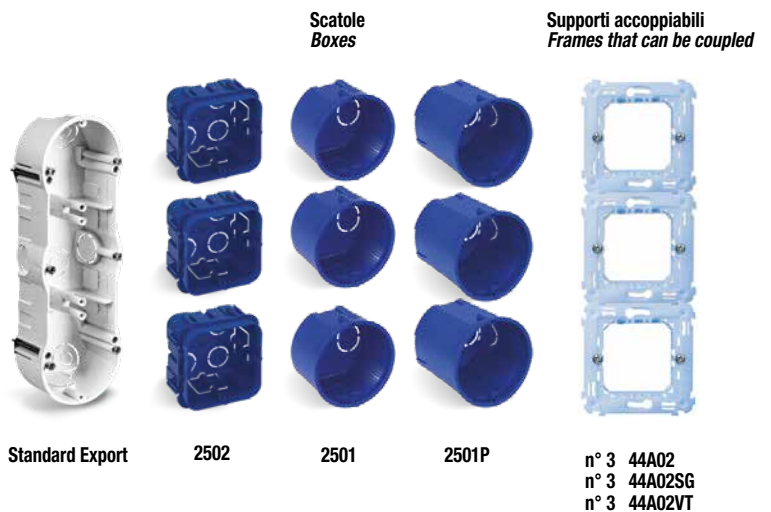

### Cornicette di ricambio Spare inner frames

Cod. Code Colore Colour Info € □ □



44CRV22B	Bianco Ral 9010 Ral 9010 white	2	50
44CRV22N	Grigio scuro lucido Polished dark grey	2	50
44CRV22CR	Cromo Chrome	2	50



Per la disponibilità contattare la rete commerciale  
For availability please contact sales dept.



Disponibilità fino ad esaurimento scorte  
Available until stock out



Prodotto per scatola rettangolare inglese  
Product for British standard rectangular box



Prodotto per Export  
For Export only

**Placche "Vera 44" per scatola tonda o quadrata**  
**"Vera 44" front plates for round or square box**

8(2+2+2+2) MODULI 8(2+2+2+2) MODULES	Cod. Code	Colore Colour	Cornicetta Inner frame	Info	€	□	□
--------------------------------------	-----------	---------------	------------------------	------	---	---	---

209



<b>Corian®</b>							
<b>44PCT28B</b>	Bianco White		-			6	6

Sistema 45

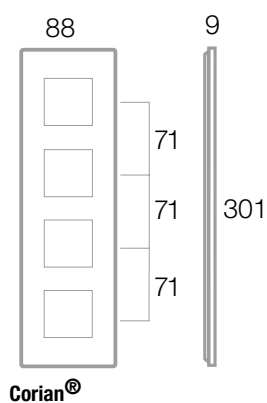

Scatole  
Boxes



2502      2501      2501P

Supporti accoppiabili  
Frames that can be coupled

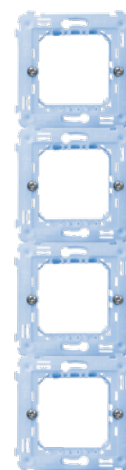

n° 4 44A02  
n° 4 44A02SG  
n° 4 44A02VT



# Placche

## Front Plates



### Placche "Vera 44" per scatola rettangolare

#### "Vera 44" front plates for rectangular box

210

3 MODULI 3 MODULES

Cod. Code Colore Colour

Cornicetta Inner frame

Info

€



### Legno massello Wood

44PL3RS	Rovere sbiancato Whitened oak	Cromo Chrome	1	1
44PL3WG	Wengé Wenge	Grigio scuro lucido Polished dark grey	1	1



### Corian®

44PCN3B	Bianco White	-	1	1
---------	-----------------	---	---	---

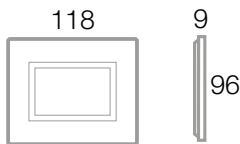

Alluminio e Legno  
Aluminium and Wood

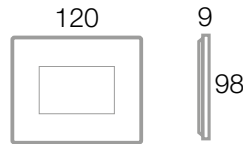

Corian®

### Supporto da utilizzare To be used with



44A03

### Cornicette di ricambio Spare inner frames

Cod. Code	Colore Colour	Info	€	□	□
44CRV3B	Bianco Ral 9010 Ral 9010 white	2	50		
44CRV3N	Grigio scuro lucido Polished dark grey	2	50		
44CRV3CR	Cromo Chrome	2	50		



### Ring di finitura Finishing ring

Cod. Code	Colore Colour	Info	€	□	□
44RNG3B	Bianco Ral 9010 Ral 9010 white	2	50		
44RNG3N	Grigio scuro lucido Polished dark grey	2	50		



Per la disponibilità contattare la rete commerciale  
For availability please contact sales dept.



Disponibilità fino ad esaurimento scorte  
Available until stock out



Prodotto per scatola rettangolare inglese  
Product for British standard rectangular box



Prodotto per Export  
For Export only

Placche "Vera 44" per scatola rettangolare  
"Vera 44" front plates for rectangular box

4 MODULI 4 MODULES	Cod. Code	Colore Colour	Cornicetta Inner frame	Info	€	<input type="checkbox"/>	<input type="checkbox"/>
--------------------	-----------	---------------	------------------------	------	---	--------------------------	--------------------------

211



**Legno massello Wood**

44PL4RS	Rovere sbiancato Whitened oak	Cromo Chrome	1	1
44PL4WG	Wengé Wenge	Grigio scuro lucido Polished dark grey	1	1



**Corian®**

44PCN4B	Bianco White	-	1	1
---------	-----------------	---	---	---

Sistema 45



Alluminio e Legno  
Aluminium and Wood

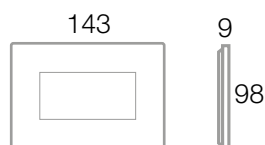

Corian®

**Supporto da utilizzare  
To be used with**



44A04

**Cornicette di ricambio Spare inner frames**

	Cod. Code	Colore Colour	Info	€	<input type="checkbox"/>	<input type="checkbox"/>
	44CRV4B	Bianco Ral 9010 Ral 9010 white	2	50		
	44CRV4N	Grigio scuro lucido Polished dark grey	2	50		
	44CRV4CR	Cromo Chrome	2	50		

**Ring di finitura Finishing ring**

	Cod. Code	Colore Colour	Info	€	<input type="checkbox"/>	<input type="checkbox"/>
	44RNG4B	Bianco Ral 9010 Ral 9010 white	2	50		
	44RNG4N	Grigio scuro lucido Polished dark grey	2	50		



# Placche

## Front Plates

### Placche "Vera 44" per scatola rettangolare

"Vera 44" front plates for rectangular box

212

7 MODULI 7 MODULES

Cod. Code Colore Colour Cornicetta Inner frame

Info € □ □



#### Legno massello Wood

44PL7RS	Rovere sbiancato Whitened oak	Cromo Chrome	1	1
44PL7WG	Wengé Wenge	Grigio scuro lucido Polished dark grey	1	1



#### Corian®

44PCN7B	Bianco White	-	1	1
---------	-----------------	---	---	---

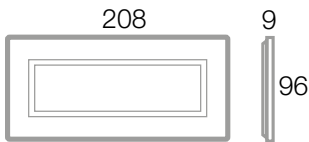

Alluminio e Legno  
Aluminium and Wood

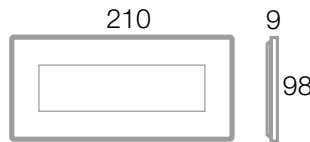

Corian®

#### Supporto da utilizzare

To be used with



44A07

### Cornicette di ricambio Spare inner frames

	Cod. Code	Colore Colour	Info	€	□	□
	44CRV7B	Bianco Ral 9010 Ral 9010 white	2	30		
	44CRV7N	Grigio scuro lucido Polished dark grey	2	30		
	44CRV7CR	Cromo Chrome	2	30		



Per la disponibilità contattare la rete commerciale  
For availability please contact sales dept.



Disponibilità fino ad esaurimento scorte  
Available until stock out



Prodotto per scatola rettangolare inglese  
Product for British standard rectangular box



Prodotto per Export  
For Export only



Placche "Vera 44" per scatola BL02P  
 "Vera 44" front plates for BL02P box

6(3+3) MODULI 6(3+3) MODULES	Cod. Code	Colore Colour	Cornicetta Inner frame	Info	€	□	□
------------------------------	-----------	---------------	------------------------	------	---	---	---

213



Legno massello Wood

44PL33RS	Rovere sbiancato Whitened oak	Cromo Chrome	1	1
44PL33WG	Wengé Wenge	Grigio scuro lucido Polished dark grey	1	1

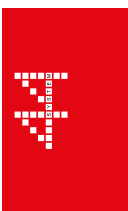

Sistema 45

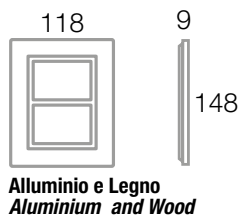

Alluminio e Legno  
Aluminium and Wood

Supporto da utilizzare  
To be used with



44A33

Scatola da utilizzare  
To be used with



BL02P  
Pareti in muratura  
Brickwork walls



BL02CG  
Pareti in cartongesso  
Hollow walls

Prodotti Installabili  
Product to be installed



TS01  
Touch Screen  
4,3"



44.AP01  
Diffusore acustico  
Loudspeaker

Cornicette di ricambio Spare inner frames

Cod. Code	Colore Colour	Info	€	□	□
-----------	---------------	------	---	---	---



44CRV33B	Bianco Ral 9010 Ral 9010 white	2	50
44CRV33CR	Cromo Chrome	2	50
44CRV33CR/AP	Cromo - versione senza traversino centrale da utilizzare con diffusori sonori 441AP01 o 442AP01 Chrome - version without central cross bar to be used with 441AP01 or 442AP01 loudspeakers	2	50

Le dimensioni, salvo diversamente specificato, sono in mm  
 Dimensions, except where otherwise specified, are in mm

□ Imballo Minimo pcs  
 Min. Packaging pcs

□ Imballo Standard pcs  
 Std. Packaging pcs

# Placche

## Front Plates

214

I colori delle placche "Zama 44" per scatola rettangolare  
"Zama 44" front plates colours for rectangular box

Design:  
L. Merletti

Metallo *Metal*



**44P93ALS**  
Alluminio naturale  
*Natural aluminium*



**44P93AO**  
Argento opaco  
*Matt silver*



**44P93B**  
Bianco RAL 9010  
*RAL 9010 white*

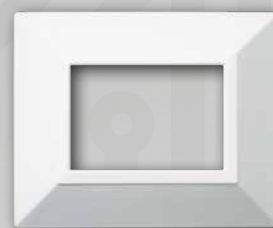

**44P93BMC**  
Bianco lucido micalizzato  
*Micalized polished white*



**44P93GF**  
Grafite  
*Graphite*



**44P93GSM**  
Grigio scuro metallizzato  
*Metallic dark grey*



**44P93GTK**  
Grigio Tekla  
*Tekla grey*



**44P93NAL**  
Nero assoluto lucido  
*Polished absolute black*



**44P93NCS**  
Nichel spazzolato  
*Brushed nickel*



**44P930T**  
Ottone lucido  
*Polished brass*



**44P93PERS**  
Trattamento superficiale verniciabile - NON E' UN COLORE  
*Treated surface (paintable) - IT IS NOT A COLOUR*

**I formati placche ZAMA 44**  
**ZAMA 44 front plates size**

**Metallo Metal**

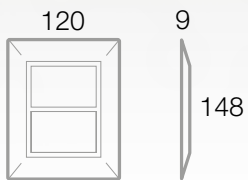
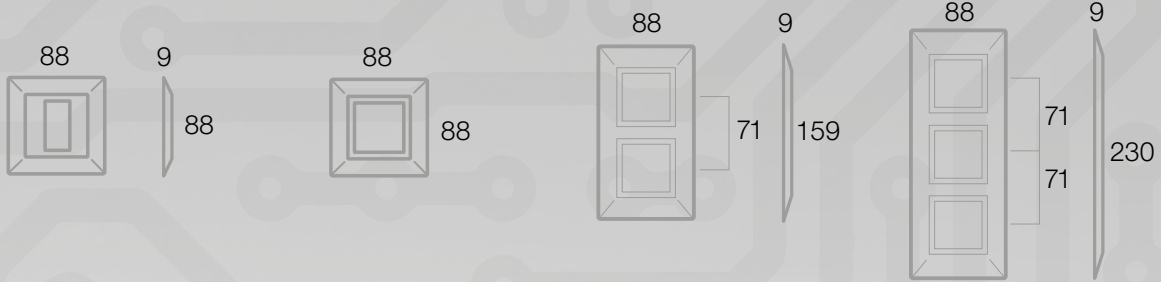

**Plastica Moulded**

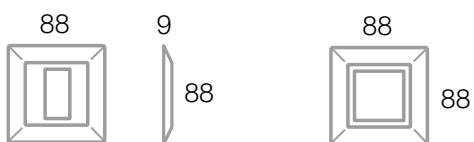



# Placche

## Front Plates



Placche in **plastica** "Pyramis 44" per scatola tonda o quadrata  
 "Pyramis 44" **moulded front plates** for round or square box

216

1 MODULO 1 MODULE



Cod. Code	Colore Colour	Cornicetta Inner frame	Info	€	□	□
44PTK21A0	Argento opaco <i>Matt silver</i>	Grigio scuro lucido <i>Polished dark grey</i>			1	30
44PTK21AP	Arancione opalino - semitrasparente <i>Opaline orange - semi-transparent</i>	Bianco Ral 9010 <i>Ral 9010 white</i>			1	30
44PTK21B	Bianco Ral 9010 <i>Ral 9010 white</i>	Bianco Ral 9010 <i>Ral 9010 white</i>			1	30
44PTK21CHO	Champagne opaco <i>Matt champagne</i>	Bianco Ral 9010 <i>Ral 9010 white</i>			1	30
44PTK21GD	Giada opalino - semitrasparente <i>Opaline jade - semi-transparent</i>	Bianco Ral 9010 <i>Ral 9010 white</i>			1	30
44PTK21GSL	Grigio scuro lucido (colore Life Touch) <i>Polished dark grey (Life Touch colour)</i>	Grigio scuro lucido <i>Polished dark grey</i>			1	30
44PTK21GSM	Grigio scuro metallizzato <i>Metallic dark grey</i>	Grigio scuro lucido <i>Polished dark grey</i>			1	30
44PTK21M	Marmo <i>Marble</i>	Bianco Ral 9010 <i>Ral 9010 white</i>			1	30
44PTK21OT	Ottone lucido <i>Polished brass</i>	Cromo <i>Chrome</i>			1	30
44PTK21PS	Pesca opalino - semitrasparente <i>Opaline peach - semi-transparent</i>	Bianco Ral 9010 <i>Ral 9010 white</i>			1	30
44PTK21RD	Radica opaca <i>Matt briarwood</i>	Cromo <i>Chrome</i>			1	30
44PTK21SA	Sabbia Ral 1013 <i>Ral 1013 sand</i>	Bianco Ral 9010 <i>Ral 9010 white</i>			1	30

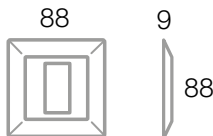

Supporto da utilizzare  
 To be used with



44A02  
 44A02SG  
 44A02VT

### Cornicette di ricambio Spare inner frames

Cod. Code	Colore Colour	Info	€	□	□
44CRK21B	Bianco Ral 9010 <i>Ral 9010 white</i>			2	50
44CRK21N	Grigio scuro lucido <i>Polished dark grey</i>			2	50
44CRK21CR	Cromo <i>Chrome</i>			2	50



Per la disponibilità contattare  
 la rete commerciale  
 For availability please contact  
 sales dept.



Disponibilità fino ad  
 esaurimento scorte  
 Available until stock out



Prodotto per scatola  
 rettangolare inglese  
 Product for British standard  
 rectangular box



Prodotto  
 per Export  
 For Export  
 only

Placche in **plastica** "Pyramis 44" per scatola tonda o quadrata  
 "Pyramis 44" **moulded** front plates for round or square box

2 MODULI 2 MODULES	Cod. Code	Colore Colour	Cornicetta Inner frame	Info	€	□	□
	44PTK22AO	Argento opaco Matt silver	Grigio scuro lucido Polished dark grey			1	30
	44PTK22AP	Arancione opalino - semitrasparente Opaline orange - semi-transparent	Bianco Ral 9010 Ral 9010 white			1	30
	44PTK22B	Bianco Ral 9010 Ral 9010 white	Bianco Ral 9010 Ral 9010 white			1	30
	44PTK22CHO	Champagne opaco Matt champagne	Bianco Ral 9010 Ral 9010 white			1	30
	44PTK22GD	Giada opalino - semitrasparente Opaline jade - semi-transparent	Bianco Ral 9010 Ral 9010 white			1	30
	44PTK22GSL	Grigio scuro lucido (colore Life Touch) Polished dark grey (Life Touch colour)	Grigio scuro lucido Polished dark grey			1	30
	44PTK22M	Marmo Marble	Bianco Ral 9010 Ral 9010 white			1	30
	44PTK22OT	Ottone lucido Polished brass	Cromo Chrome			1	30
	44PTK22PS	Pesca opalino - semitrasparente Opaline peach - semi-transparent	Bianco Ral 9010 Ral 9010 white			1	30
	44PTK22RD	Radica opaca Matt briarwood	Cromo Chrome			1	30
	44PTK22SA	Sabbia Ral 1013 Ral 1013 sand	Bianco Ral 9010 Ral 9010 white			1	30

217

Sistema 45

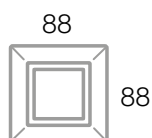

Supporto da utilizzare  
To be used with



44A02  
44A02SG  
44A02VT

Cornicette di ricambio Spare inner frames

	Cod. Code	Colore Colour	Info	€	□	□
	44CRK22B	Bianco Ral 9010 Ral 9010 white			2	50
	44CRK22N	Grigio scuro lucido Polished dark grey			2	50
	44CRK22CR	Cromo Chrome			2	50



# Placche

## Front Plates



Placche in **metallo** "Zama 44" per scatola tonda o quadrata  
 "Zama 44" **metal** front plates for round or square box

BREVETTO DESIGN AVE n° 206  
 AVE DESIGN PATENT n° 206

218

1 MODULO 1 MODULE



Cod. Code	Colore Colour	Cornicetta Inner frame	Info	€	□	□
44PK21ALS	Alluminio naturale Natural aluminium	Cromo Chrome		1	15	
44PK21AO	Argento opaco Matt silver	Grigio scuro lucido Polished dark grey		1	15	
44PK21B	Bianco Ral 9010 Ral 9010 white	Bianco Ral 9010 Ral 9010 white		1	15	
44PK21BMC	Bianco lucido micalizzato Micalized polished white	Bianco Ral 9010 Ral 9010 white		1	15	
44PK21GSM	Grigio scuro metallizzato Metallic dark grey	Cromo Chrome		1	15	
44PK21NCS	Nichel spazzolato Brushed nickel	Grigio scuro lucido Polished dark grey		1	15	
44PK21OT	Ottone lucido Polished brass	Cromo Chrome		1	15	
44PK21PERS	Tattamento superficiale verniciabile NON E' UN COLORE Treated surface (paintable) IT IS NOT A COLOUR	Bianco Ral 9010 (in dotazione) Grigio scuro lucido (in dotazione) RAL 9010 white (included) Polished dark grey (included)		1	15	

- Note:**
- ✓ 44PK21PERS è realizzata con uno speciale trattamento in modo da poter essere dipinta con tutte le vernici/smalti ad acqua oppure idropitture per esterno ed interno comunemente in vendita. Non vanno invece utilizzate vernici a base di alcool o diluibili in alcool e vernici a base nitro o diluibili con solventi a base nitro
  - ✓ Ricordarsi di verniciare la placca prima dell'aggancio della cornicetta e del montaggio sul supporto
  - ✓ 44PK21PERS is specially treated to be painted with any common water-based paint or enamel for indoor and outdoor. Do not use alcohol-based nor nitro-based paints or catalysts.
  - ✓ Paint the front plate before hooking the inner frame and before mounting it.

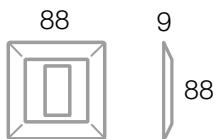

Supporto da utilizzare  
 To be used with



44A02  
 44A02SG  
 44A02VT

### Cornicette di ricambio Spare inner frames



Cod. Code	Colore Colour	Info	€	□	□
44CRK21B	Bianco Ral 9010 Ral 9010 white		2	50	
44CRK21N	Grigio scuro lucido Polished dark grey		2	50	
44CRK21CR	Cromo Chrome		2	50	



Per la disponibilità contattare la rete commerciale  
 For availability please contact sales dept.



Disponibilità fino ad esaurimento scorte  
 Available until stock out



Prodotto per scatola rettangolare inglese  
 Product for British standard rectangular box



Prodotto per Export  
 For Export only

Placche in **metallo** "Zama 44" per scatola tonda o quadrata  
 "Zama 44" **metal** front plates for round or square box

BREVETTO DESIGN AVE N° 206  
 AVE DESIGN PATENT N° 206

2 MODULI 2 MODULES	Cod. Code	Colore Colour	Cornicetta Inner frame	Info	€	□	□
	44PK22ALS	Alluminio naturale Natural aluminium	Cromo Chrome			1	15
	44PK22AO	Argento opaco Matt silver	Grigio scuro lucido Polished dark grey			1	15
	44PK22B	Bianco Ral 9010 Ral 9010 white	Bianco Ral 9010 Ral 9010 white			1	15
	44PK22BMC	Bianco lucido micalizzato Micalized polished white	Bianco Ral 9010 Ral 9010 white			1	15
	44PK22GF	Grafite Graphite	Grigio scuro lucido Polished dark grey			1	15
	44PK22GSM	Grigio scuro metallizzato Metallic dark grey	Cromo Chrome			1	15
	44PK22GTK	Grigio Tekla Tekla grey	Cromo Chrome			1	15
	44PK22NAL	Nero assoluto lucido Polished absolute black	Cromo Chrome			1	15
	44PK22NCS	Nichel spazzolato Brushed nickel	Grigio scuro lucido Polished dark grey			1	15
	44PK22OT	Ottone lucido Polished brass	Cromo Chrome			1	15
	44PK22PERS	Trattamento superficiale verniciabile NON E' UN COLORE Treated surface (paintable) IT IS NOT A COLOUR	Bianco Ral 9010 (in dotazione) Grigio scuro lucido (in dotazione) RAL 9010 white (included) Polished dark grey (included)			1	15

- Note:**
- ✓ 44PK22PERS è realizzata con uno speciale trattamento in modo da poter essere dipinta con tutte le vernici/smalti ad acqua oppure idropitture per esterno ed interno comunemente in vendita. Non vanno invece utilizzate vernici a base di alcool o diluibili in alcool e vernici a base nitro o diluibili con solventi a base nitro
  - ✓ Ricordarsi di verniciare la placca prima dell'aggancio della cornicetta e del montaggio sul supporto
  - ✓ 44PK22PERS is specially treated to be painted with any common water-based paint or enamel for indoor and outdoor. Do not use alcohol-based nor nitro-based paints or catalysts.
  - ✓ Paint the front plate before hooking the inner frame and before mounting it.

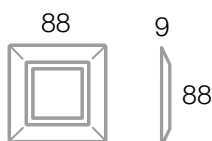

Supporto da utilizzare  
To be used with



44A02  
44A02SG  
44A02VT

Cornicette di ricambio *Spare inner frames*

	Cod. Code	Colore Colour	Info	€	□	□
	44CRK22B	Bianco Ral 9010 Ral 9010 white			2	50
	44CRK22N	Grigio scuro lucido Polished dark grey			2	50
	44CRK22CR	Cromo Chrome			2	50

Le dimensioni, salvo diversamente specificato, sono in mm  
 Dimensions, except where otherwise specified, are in mm

Imballo Minimo pcs  
Min. Packaging pcs

Imballo Standard pcs  
Std. Packaging pcs





# Placche Front Plates



Placche in **metallo** "Zama 44" per scatola tonda o quadrata  
"Zama 44" **metal** front plates for round or square box

BREVETTO DESIGN AVE n° 206  
AVE DESIGN PATENT n° 206

220

4(2+2) MODULI 4(2+2) MODULES	Cod. Code	Colore Colour	Cornicetta Inner frame	Info	€	<input type="checkbox"/>	<input type="checkbox"/>
	44PK24ALS	Alluminio naturale Natural aluminium	Cromo Chrome	1	10		
	44PK24B	Bianco Ral 9010 Ral 9010 white	Bianco Ral 9010 Ral 9010 white	1	10		
	44PK24BMC	Bianco lucido micalizzato Micalized polished white	Bianco Ral 9010 Ral 9010 white	1	10		
	44PK24GF	Grafite Graphite	Grigio scuro lucido Polished dark grey	1	10		
	44PK24GSM	Grigio scuro metallizzato Metallic dark grey	Cromo Chrome	1	10		
	44PK24GTK	Grigio Tekla Tekla grey	Cromo Chrome	1	10		
	44PK24NAL	Nero assoluto lucido Polished absolute black	Cromo Chrome	1	10		
	44PK24NCS	Nichel spazzolato Brushed nickel	Grigio scuro lucido Polished dark grey	1	10		
	44PK24OT	Ottone lucido Polished brass	Cromo Chrome	1	10		
	44PK24PERS	Tattamento superficiale verniciabile NON E' UN COLORE Treated surface (paintable) IT IS NOT A COLOUR	Bianco Ral 9010 (in dotazione) Grigio scuro lucido (in dotazione) RAL 9010 white (included) Polished dark grey (included)	1	10		

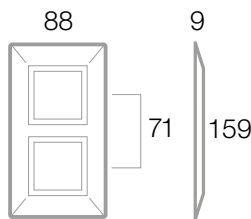

**Note:** ✓ 44PK24PERS è realizzata con uno speciale trattamento in modo da poter essere dipinta con tutte le vernici/smalti ad acqua oppure idropitture per esterno ed interno comunemente in vendita. Non vanno invece utilizzate vernici a base di alcool o diluibili in alcool e vernici a base nitro o diluibili con solventi a base nitro  
 ✓ Ricordarsi di verniciare la placca prima dell'aggancio della cornicetta e del montaggio sul supporto  
 ✓ 44PK24PERS is specially treated to be painted with any common water-based paint or enamel for indoor and outdoor. Do not use alcohol-based nor nitro-based paints or catalysts.  
 ✓ Paint the front plate before hooking the inner frame and before mounting it.

### Soluzione Installativa Installation solution

Supporto da utilizzare  
To be used with



n° 2 44A02  
n° 2 44A02SG  
n° 2 44A02VT

Scatole  
Boxes



Standard Export 2502 2501 2501P



Supporti accoppiabili  
Frames that can be coupled



Placca  
Front plate

### Cornicette di ricambio Spare inner frames

	Cod. Code	Colore Colour	Info	€	<input type="checkbox"/>	<input type="checkbox"/>
	44CRK22B	Bianco Ral 9010 Ral 9010 white	2	50		
	44CRK22N	Grigio scuro lucido Polished dark grey	2	50		
	44CRK22CR	Cromo Chrome	2	50		



Per la disponibilità contattare la rete commerciale  
For availability please contact sales dept.



Disponibilità fino ad esaurimento scorte  
Available until stock out



Prodotto per scatola rettangolare inglese  
Product for British standard rectangular box



Prodotto per Export For Export only

## Placche in metallo "Zama 44" per scatola tonda o quadrata "Zama 44" metal front plates for round or square box

BREVETTO DESIGN AVE N° 206  
AVE DESIGN PATENT N° 206

6(2+2+2) MODULI 6(2+2+2) MODULES	Cod. Code	Colore Colour	Cornicetta Inner frame	Info	€	<input type="checkbox"/>	<input type="checkbox"/>	221
	44PK26ALS	Alluminio naturale Natural aluminium	Cromo Chrome			1	5	
	44PK26B	Bianco Ral 9010 Ral 9010 white	Bianco Ral 9010 Ral 9010 white			1	5	
	44PK26BMC	Bianco lucido micalizzato Micalized polished white	Bianco Ral 9010 Ral 9010 white			1	5	
	44PK26GF	Grafite Graphite	Grigio scuro lucido Polished dark grey			1	5	
	44PK26GSM	Grigio scuro metallizzato Metallic dark grey	Cromo Chrome			1	5	
	44PK26GTK	Grigio Tekla Tekla grey	Cromo Chrome			1	5	
	44PK26NAL	Nero assoluto lucido Polished absolute black	Cromo Chrome			1	5	
	44PK26NCS	Nichel spazzolato Brushed nickel	Grigio scuro lucido Polished dark grey			1	5	
	44PK26OT	Ottone lucido Polished brass	Cromo Chrome			1	5	
	44PK26PERS	Tattamento superficiale verniciabile NON E' UN COLORE Treated surface (paintable) IT IS NOT A COLOUR	Bianco Ral 9010 (in dotazione) Grigio scuro lucido (in dotazione) RAL 9010 vwhite (included) Polished dark grey (included)			1	5	

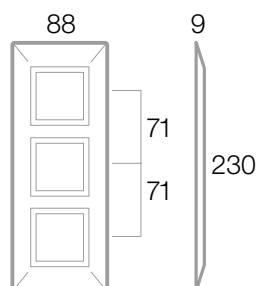

- Note:**
- ✓ 44PK26PERS è realizzata con uno speciale trattamento in modo da poter essere dipinta con tutte le vernici/smalti ad acqua oppure idropitture per esterno ed interno comunemente in vendita. Non vanno invece utilizzate vernici a base di alcool o diluibili in alcool e vernici a base nitro o diluibili con solventi a base nitro
  - ✓ Ricordarsi di verniciare la placca prima dell'aggancio della cornicetta e del montaggio sul supporto
  - ✓ 44PK26PERS is specially treated to be painted with any common water-based paint or enamel for indoor and outdoor. Do not use alcohol-based nor nitro-based paints or catalysts.
  - ✓ Paint the front plate before hooking the inner frame and before mounting it.

### Soluzione Installativa Installation solution

Supporto da utilizzare  
To be used with



n° 3 44A02  
n° 3 44A02SG  
n° 3 44A02VT

Scatole  
Boxes

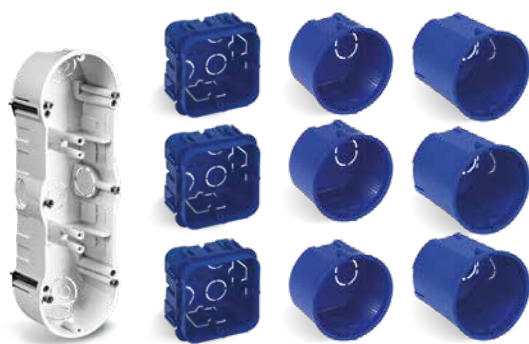

Standard Export

2502

2501

2501P



Supporti accoppiabili  
Frames that can be coupled



Placca  
Front plate

### Cornicette di ricambio Spare inner frames

Cod. Code	Colore Colour	Info	€	<input type="checkbox"/>	<input type="checkbox"/>
44CRK22B	Bianco Ral 9010 Ral 9010 white			2	50
44CRK22N	Grigio scuro lucido Polished dark grey			2	50
44CRK22CR	Cromo Chrome			2	50



Le dimensioni, salvo diversamente specificato, sono in mm  
Dimensions, except where otherwise specified, are in mm

Imballo Minimo pcs  
Min. Packaging pcs

Imballo Standard pcs  
Std. Packaging pcs



# Placche

## Front Plates



### Placche in metallo "Zama 44" per scatola rettangolare "Zama 44" metal front plates for rectangular box

BREVETTO DESIGN AVE n° 206  
AVE DESIGN PATENT n° 206

222

3 MODULI 3 MODULES



Cod. Code	Colore Colour	Cornicetta Inner frame	Info	€	□	□
44P93ALS	Alluminio naturale Natural aluminium	Cromo Chrome		1	12	
44P93AO	Argento opaco Matt silver	Grigio scuro lucido Polished dark grey		1	12	
44P93B	Bianco Ral 9010 Ral 9010 white	Bianco Ral 9010 Ral 9010 white		1	12	
44P93BMC	Bianco lucido micalizzato Micalized polished white	Bianco Ral 9010 Ral 9010 white		1	12	
44P93GF	Grafite Graphite	Grigio scuro lucido Polished dark grey		1	12	
44P93GSM	Grigio scuro metallizzato Metallic dark grey	Cromo Chrome		1	12	
44P93GTK	Grigio Tekla Tekla grey	Cromo Chrome		1	12	
44P93NAL	Nero assoluto lucido Polished absolute black	Cromo Chrome		1	12	
44P93NCS	Nichel spazzolato Brushed nickel	Grigio scuro lucido Polished dark grey		1	12	
44P93OT	Ottone lucido Polished brass	Cromo Chrome		1	12	
44P93PERS	Trattamento superficiale verniciabile NON E' UN COLORE Treated surface (paintable) IT IS NOT A COLOUR	Bianco Ral 9010 (in dotazione) Grigio scuro lucido (in dotazione) RAL 9010 white (included) Polished dark grey (included)		1	12	

- Note:**
- ✓ 44P93PERS è realizzata con uno speciale trattamento in modo da poter essere dipinta con tutte le vernici/smalti ad acqua oppure idropitture per esterno ed interno comunemente in vendita. Non vanno invece utilizzate vernici a base di alcool o diluibili in alcool e vernici a base nitro o diluibili con solventi a base nitro
  - ✓ Ricordarsi di verniciare la placca prima dell'aggancio della cornicetta e del montaggio sul supporto
  - ✓ 44P93PERS is specially treated to be painted with any common water-based paint or enamel for indoor and outdoor. Do not use alcohol-based nor nitro-based paints or catalysts.
  - ✓ Paint the front plate before hooking the inner frame and before mounting it.

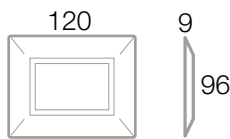

Supporto da utilizzare  
To be used with



44A03

### Cornicette di ricambio Spare inner frames



Cod. Code	Colore Colour	Info	€	□	□
44CR3B	Bianco Ral 9010 Ral 9010 white		2	50	
44CR3N	Grigio scuro lucido Polished dark grey		2	50	
44CR3CR	Cromo Chrome		2	50	



Per la disponibilità contattare la rete commerciale  
For availability please contact sales dept.



Disponibilità fino ad esaurimento scorte  
Available until stock out



Prodotto per scatola rettangolare inglese  
Product for British standard rectangular box



Prodotto per Export  
For Export only

## Placche in metallo "Zama 44" per scatola rettangolare "Zama 44" metal front plates for rectangular box

BREVETTO DESIGN AVE N° 206  
AVE DESIGN PATENT N° 206

4 MODULI 4 MODULES	Cod. Code	Colore Colour	Cornicetta Inner frame	Info	€	□	□
	44P94ALS	Alluminio naturale Natural aluminium	Cromo Chrome			1	10
	44P94AO	Argento opaco Matt silver	Grigio scuro lucido Polished dark grey			1	10
	44P94B	Bianco Ral 9010 Ral 9010 white	Bianco Ral 9010 Ral 9010 white			1	10
	44P94BMC	Bianco lucido micalizzato Micalized polished white	Bianco Ral 9010 Ral 9010 white			1	10
	44P94GF	Grafite Graphite	Grigio scuro lucido Polished dark grey			1	10
	44P94GSM	Grigio scuro metallizzato Metallic dark grey	Cromo Chrome			1	10
	44P94GTK	Grigio Tekla Tekla grey	Cromo Chrome			1	10
	44P94NAL	Nero assoluto lucido Polished absolute black	Cromo Chrome			1	10
	44P94NCS	Nichel spazzolato Brushed nickel	Grigio scuro lucido Polished dark grey			1	10
	44P94OT	Ottone lucido Polished brass	Cromo Chrome			1	10
	44P94PERS	Trattamento superficiale verniciabile NON E' UN COLORE Treated surface (paintable) IT IS NOT A COLOUR	Bianco Ral 9010 (in dotazione) Grigio scuro lucido (in dotazione) RAL 9010 white (included) Polished dark grey (included)			1	10

- Note:**
- ✓ 44P94PERS è realizzata con uno speciale trattamento in modo da poter essere dipinta con tutte le vernici/smalti ad acqua oppure idropitture per esterno ed interno comunemente in vendita. Non vanno invece utilizzate vernici a base di alcool o diluibili in alcool e vernici a base nitro o diluibili con solventi a base nitro
  - ✓ Ricordarsi di verniciare la placca prima dell'aggancio della cornicetta e del montaggio sul supporto
  - ✓ 44P94PERS is specially treated to be painted with any common water-based paint or enamel for indoor and outdoor. Do not use alcohol-based nor nitro-based paints or catalysts.
  - ✓ Paint the front plate before hooking the inner frame and before mounting it.

### Supporto da utilizzare To be used with

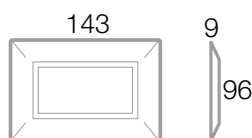

44A04

### Cornicette di ricambio Spare inner frames

	Cod. Code	Colore Colour	Info	€	□	□
	44CR4B	Bianco Ral 9010 Ral 9010 white			2	50
	44CR4N	Grigio scuro lucido Polished dark grey			2	50
	44CR4CR	Cromo Chrome			2	50

Le dimensioni, salvo diversamente specificato, sono in mm  
Dimensions, except where otherwise specified, are in mm

 Imballo Minimo pcs  
Min. Packaging pcs

 Imballo Standard pcs  
Std. Packaging pcs



# Placche

## Front Plates

### Placche in metallo "Zama 44" per scatola rettangolare

"Zama 44" metal front plates for rectangular box

224

7 MODULI 7 MODULES



Cod. Code	Colore Colour	Cornicetta Inner frame	Info	€	□	□
44P97ALS	Alluminio naturale Natural aluminium	Cromo Chrome		1	5	
44P97AO	Argento opaco Matt silver	Grigio scuro lucido Polished dark grey		1	5	
44P97B	Bianco Ral 9010 Ral 9010 white	Bianco Ral 9010 Ral 9010 white		1	5	
44P97BMC	Bianco lucido micalizzato Micalized polished white	Bianco Ral 9010 Ral 9010 white		1	5	
44P97GF	Grafite Graphite	Grigio scuro lucido Polished dark grey		1	5	
44P97GSM	Grigio scuro metallizzato Metallic dark grey	Cromo Chrome		1	5	
44P97GTK	Grigio Tekla Tekla grey	Cromo Chrome		1	5	
44P97NAL	Nero assoluto lucido Polished absolute black	Cromo Chrome		1	5	
44P97NCS	Nichel spazzolato Brushed nickel	Grigio scuro lucido Polished dark grey		1	5	
44P97OT	Ottone lucido Polished brass	Cromo Chrome		1	5	
44P97PERS	Trattamento superficiale verniciabile NON E' UN COLORE Treated surface (paintable) IT IS NOT A COLOUR	Bianco Ral 9010 (in dotazione) Grigio scuro lucido (in dotazione) RAL 9010 white (included) Polished dark grey (included)		1	5	

- Note:**
- ✓ 44P97PERS è realizzata con uno speciale trattamento in modo da poter essere dipinta con tutte le vernici/smalti ad acqua oppure idropitture per esterno ed interno comunemente in vendita. Non vanno invece utilizzate vernici a base di alcool o diluibili in alcool e vernici a base nitro o diluibili con solventi a base nitro
  - ✓ Ricordarsi di verniciare la placca prima dell'aggancio della cornicetta e del montaggio sul supporto
  - ✓ 44P97PERS is specially treated to be painted with any common water-based paint or enamel for indoor and outdoor. Do not use alcohol-based nor nitro-based paints or catalysts.
  - ✓ Paint the front plate before hooking the inner frame and before mounting it.

#### Supporto da utilizzare

To be used with

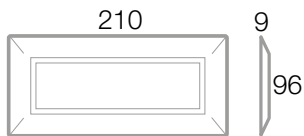

44A07

#### Cornicette di ricambio Spare inner frames

Cod. Code	Colore Colour	Info	€	□	□
44CR7B	Bianco Ral 9010 Ral 9010 white		2	30	
44CR7N	Grigio scuro lucido Polished dark grey		2	30	
44CR7CR	Cromo Chrome		2	30	



Per la disponibilità contattare la rete commerciale  
For availability please contact sales dept.



Disponibilità fino ad esaurimento scorte  
Available until stock out



Prodotto per scatola rettangolare inglese  
Product for British standard rectangular box



Prodotto per Export  
For Export only

## Placche in metallo "Zama 44" per scatola BL02P "Zama 44" metal front plates for BL02P box

BREVETTO DESIGN AVE N° 206  
AVE DESIGN PATENT N° 206

6(3+3) MODULI 6(3+3) MODULES	Cod. Code	Colore Colour	Cornicetta Inner frame	Info	€	□	□
	44P933ALS	Alluminio naturale Natural aluminium	Cromo Chrome			1	1
	44P933B	Bianco Ral 9010 Ral 9010 white	Bianco Ral 9010 Ral 9010 white			1	1
	44P933GSM	Grigio scuro metallizzato Metallic dark grey	Cromo Chrome			1	1
	44P933NAL	Nero assoluto lucido Polished absolute black	Cromo Chrome			1	1
	44P933PERS	Trattamento superficiale verniciabile NON E' UN COLORE Treated surface (paintable) IT IS NOT A COLOUR	Bianco Ral 9010 (in dotazione) Grigio scuro lucido (in dotazione) RAL 9010 white (included) Polished dark grey (included)			1	1

12(6+6) MODULI 12(6+6) MODULES	Cod. Code	Colore Colour	Cornicetta Inner frame	Info	€	□	□
	44P912ALS	Alluminio naturale Natural aluminium	Cromo Chrome			1	1
	44P912AO	Argento opaco Matt silver	Grigio scuro lucido Polished dark grey			1	1
	44P912B	Bianco Ral 9010 Ral 9010 white	Bianco Ral 9010 Ral 9010 white			1	1
	44P912BMC	Bianco lucido micalizzato Micalized polished white	Bianco Ral 9010 Ral 9010 white			1	1
	44P912GSM	Grigio scuro metallizzato Metallic dark grey	Cromo Chrome			1	1
	44P912NAL	Nero assoluto lucido Polished absolute black	Cromo Chrome			1	1
	44P912PERS	Trattamento superficiale verniciabile NON E' UN COLORE Treated surface (paintable) IT IS NOT A COLOUR	Bianco Ral 9010 (in dotazione) Grigio scuro lucido (in dotazione) RAL 9010 white (included) Polished dark grey (included)			1	1

Supporto da utilizzare  
To be used with

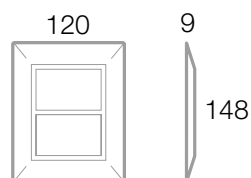

44A33

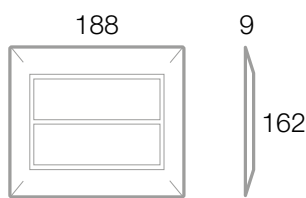

Supporto da utilizzare  
To be used with



44A12

### Cornicette di ricambio Spare inner frames

	Cod. Code	Colore Colour	Info	€	□	□
	44CR33B	Bianco Ral 9010 Ral 9010 white			2	50
	44CR33N	Grigio scuro lucido Polished dark grey			2	50
	44CR33CR	Cromo Chrome			2	50
	44CR33CR/AP	Cromo - versione senza traversino centrale da utilizzare con diffusori sonori 441AP01 o 442AP01 Chrome - version without central cross bar to be used with 441AP01 or 442AP01 loudspeakers			2	50
	44CR12N	Grigio scuro lucido Polished dark grey			2	14
	44CR12CR	Cromo Chrome			2	14

Le dimensioni, salvo diversamente specificato, sono in mm  
Dimensions, except where otherwise specified, are in mm

Imballo Minimo pcs  
Min. Packaging pcs

Imballo Standard pcs  
Std. Packaging pcs

225

Sistema 45



# Placche

## Front Plates

226

Placche "Young Touch" in tecnopolimero per scatola rettangolare  
 "Young Touch" moulded front plate for rectangular box

Design:  
L. Merletti

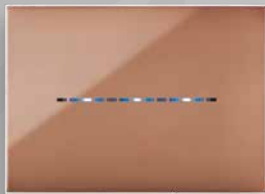

**44PJTC3AVN**  
Avana  
Havana



**44PJTC3AVR**  
Avorio  
Ivory



**44PJTC3B**  
Bianco  
White



**44PJTC3BT**  
Bianco totale  
Total white



**44PJTC3CNR**  
Cenere  
Ash



**44PJTC3GM**  
Grigio metallizzato  
Metallic grey



**44PJTC3GOLD**  
Oro  
Gold



**44PJTC3GSO**  
Gesso  
Plaster

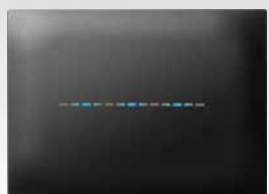

**44PJTC3GTK**  
Grigio Tekla  
Tekla grey



**44PJTC3GTKT**  
Grigio antracite  
Anthracite grey

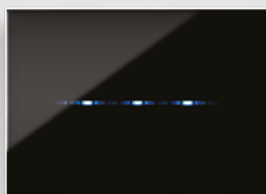

**44PJTC3NAL**  
Nero assoluto  
Absolute black



**44PJTC3SA**  
Sabbia  
Sand



**44PJTC3SAL**  
Salvia  
Sage



**44PJTC3B/3D**  
Bianco 3D  
3D white



**44PJTC3BEG/3D**  
Beige spazzolato 3D  
3D brushed beige

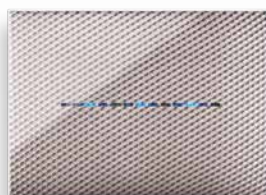

**44PJTC3CBC/3D**  
Carbon chiaro 3D  
3D clear carbon



**44PJTC3CBS/3D**  
Carbon scuro 3D  
3D dark carbon



**44PJTC3ONC/3D**  
Onice 3D  
3D onyx



Placche in tecnopolimero "Young 44" per scatola rettangolare  
"Young 44 moulded" front plates for rectangular box

Design:  
L. Merletti



**44PJ03AVN**  
Avana  
Havana



**44PJ03AVR**  
Avorio  
Ivory



**44PJ03B**  
Bianco  
White

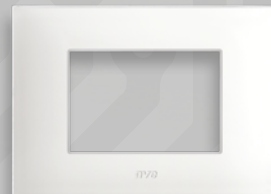

**44PJ03BT**  
Bianco totale  
Total white



**44PJ03CNR**  
Genere  
Ash



**44PJ03GM**  
Grigio metallizzato  
Metallic grey



**44PJ03GOLD**  
Oro  
Gold



**44PJ03GSO**  
Gesso  
Plaster



**44PJ03GTK**  
Grigio Tekla  
Tekla grey



**44PJ03GKT**  
Grigio antracite  
Anthracite grey



**44PJ03NAL**  
Nero assoluto  
Absolute black



**44PJ03SA**  
Sabbia  
Sand



**44PJ03SAL**  
Salvia  
Sage

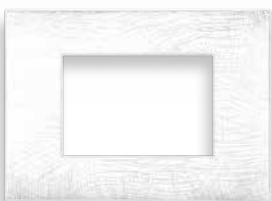

**44PJ03B/3D**  
Bianco 3D  
3D white



**44PJ03BEG/3D**  
Beige spazzolato 3D  
3D brushed beige

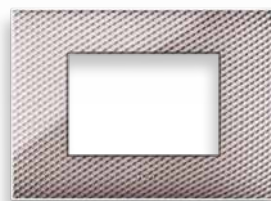

**44PJ03CBC/3D**  
Carbon chiaro 3D  
3D clear carbon



**44PJ03CBS/3D**  
Carbon scuro 3D  
3D dark carbon



**44PJ03ONG/3D**  
Onice 3D  
3D onyx

**I formati placche YOUNG TOUCH**  
**YOUNG TOUCH front plates size**



**I formati placche YOUNG 44**  
**YOUNG 44 front plates size**

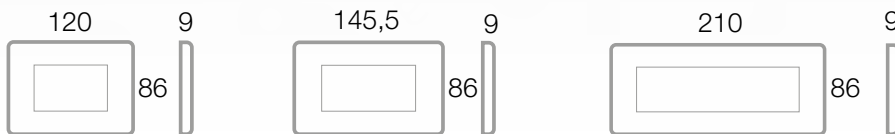
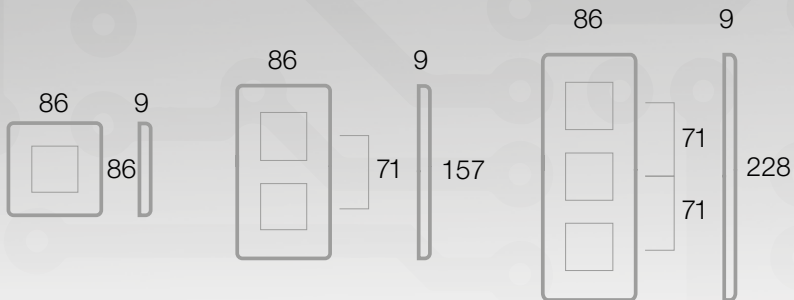

Per la disponibilità contattare  
 la rete commerciale  
 For availability please contact  
 sales dept.



Disponibilità fino ad  
 esaurimento scorte  
 Available until stock out



Prodotto per scatola  
 rettangolare inglese  
 Product for British standard  
 rectangular box



Prodotto  
 per Export  
 For Export  
 only

Placche "Young Touch" in tecnopolimero per scatola tonda o quadrata  
 "Young Touch" moulded front plates for square or round box

		Descrizione Description	Info	€	<input type="checkbox"/>	<input type="checkbox"/>	
		<b>Fino a 2 comandi "a scomparsa"</b> <b>Up to 2 "hidden" controls</b>					
<b>AVN</b>	<b>AVR</b>		■ <b>44PJTC22AVN</b> Avana Havana	1	25		
			■ <b>44PJTC22AVR</b> Avorio Ivory	1	25		
<b>B</b>	<b>BT</b>		□ <b>44PJTC22B</b> Bianco White	1	25		
			□ <b>44PJTC22BT</b> Bianco totale Total white	1	25		
<b>CNR</b>	<b>GM</b>		■ <b>44PJTC22CNR</b> Cenere Ash	1	25		
			■ <b>44PJTC22GM</b> Grigio metallizzato Metallic grey	1	25		
<b>GOLD</b>	<b>GSO</b>		■ <b>44PJTC22GOLD</b> Oro Gold	1	25		
			□ <b>44PJTC22GSO</b> Gesso Plaster	1	25		
<b>GTK</b>	<b>GTKT</b>		■ <b>44PJTC22GTK</b> Grigio Tekla Tekla grey	1	25		
			■ <b>44PJTC22GTKT</b> Grigio antracite Anthracite grey	1	25		
<b>NAL</b>	<b>SA</b>		■ <b>44PJTC22NAL</b> Nero assoluto Absolute black	1	25		
			■ <b>44PJTC22SA</b> Sabbia Sand	1	25		
<b>SAL</b>	<b>B/3D</b>		■ <b>44PJTC22SAL</b> Salvia Sage	1	25		
			□ <b>44PJTC22B/3D</b> Bianco 3D 3D white	1	25		
<b>BEG/3D</b>	<b>CBC/3D</b>		■ <b>44PJTC22BEG/3D</b> Beige spazzolato 3D 3D brushed beige	1	25		
		■ <b>44PJTC22CBC/3D</b> Carbon chiaro 3D 3D clear carbon	1	25			
<b>CBS/3D</b>	<b>ONC/3D</b>	■ <b>44PJTC22CBS/3D</b> Carbon scuro 3D 3D dark carbon	1	25			
		■ <b>44PJTC22ONC/3D</b> Onice 3D 3D onyx	1	25			

Supporto da utilizzare  
To be used with



44A02  
44A02SG  
44A02VT

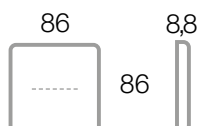

**Nota:** assicurarsi che la placca sia perfettamente aderente agli apparecchi di comando "a scomparsa"  
**Note:** make sure that the front plate sticks perfectly to the "hidden" control devices

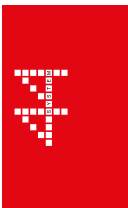



# Soluzioni AVE Touch

AVE Touch Solutions



Placche "Young Touch" in tecnopolimero per scatola 3 moduli (interasse 83,5 mm)  
"Young Touch" moulded front plates for rectangular 3 modules box (fixing centres 83,5 mm)

230



AVN



AVR

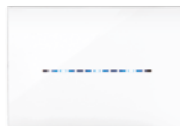

B

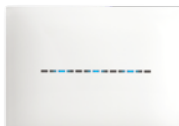

BT



CNR



GM



GOLD

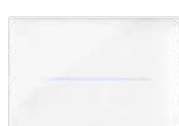

GSO



GTK



GTKT



NAL



SA



SAL



B/3D



BEG/3D

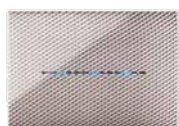

CBC/3D



CBS/3D



ONC/3D

Supporto da utilizzare  
To be used with



44A03

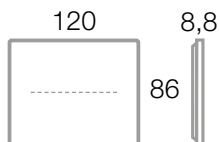

Descrizione Description

Info

€

□

□

Fino a 3 comandi "a scomparsa"  
Up to 3 "hidden" controls

■ 44PJTC3AVN Avana Havana	1	25
■ 44PJTC3AVR Avorio Ivory	1	25
□ 44PJTC3B Bianco White	1	25
□ 44PJTC3BT Bianco totale Total white	1	25
■ 44PJTC3CNR Cenere Ash	1	25
■ 44PJTC3GM Grigio metallizzato Metallic grey	1	25
■ 44PJTC3GOLD Oro Gold	1	25
□ 44PJTC3GSO Gesso Plaster	1	25
■ 44PJTC3GTK Grigio Tekla Tekla grey	1	25
■ 44PJTC3GTKT Grigio antracite Anthracite grey	1	25
■ 44PJTC3NAL Nero assoluto Absolute black	1	25
■ 44PJTC3SA Sabbia Sand	1	25
■ 44PJTC3SAL Salvia Sage	1	25
□ 44PJTC3B/3D Bianco 3D 3D white	1	25
■ 44PJTC3BEG/3D Beige spazzolato 3D 3D brushed beige	1	25
■ 44PJTC3CBC/3D Carbon chiaro 3D 3D clear carbon	1	25
■ 44PJTC3CBS/3D Carbon scuro 3D 3D dark carbon	1	25
■ 44PJTC3ONC/3D Onice 3D 3D onyx	1	25

Nota: assicurarsi che la placca sia perfettamente aderente agli apparecchi di comando "a scomparsa"

Note: make sure that the front plate sticks perfectly to the "hidden" control devices



Per la disponibilità contattare la rete commerciale  
For availability please contact sales dept.



Disponibilità fino ad esaurimento scorte  
Available until stock out



Prodotto per scatola rettangolare inglese  
Product for British standard rectangular box



Prodotto per Export  
For Export only

Placche "Young Touch" in tecnopolimero per scatola 4 moduli (interasse 108,5 mm)  
 "Young Touch" moulded front plates for rectangular 4 modules box (fixing centres 108,5 mm)

Descrizione Description		Info	€	<input type="checkbox"/>	<input type="checkbox"/>
<p>Fino a 4 comandi "a scomparsa"            Up to 4 "hidden" controls</p>					
		<b>44PJTC4AVN</b> Avana Havana	1	20	
		<b>44PJTC4AVR</b> Avorio Ivory	1	20	
		<input type="checkbox"/> <b>44PJTC4B</b> Bianco White	1	20	
		<input type="checkbox"/> <b>44PJTC4BT</b> Bianco totale Total white	1	20	
		<input checked="" type="checkbox"/> <b>44PJTC4CNR</b> Cenere Ash	1	20	
		<input checked="" type="checkbox"/> <b>44PJTC4GM</b> Grigio metallizzato Metallic grey	1	20	
		<input checked="" type="checkbox"/> <b>44PJTC4GOLD</b> Oro Gold	1	20	
		<input type="checkbox"/> <b>44PJTC4GSO</b> Gesso Plaster	1	20	
		<input checked="" type="checkbox"/> <b>44PJTC4GTK</b> Grigio Tekla Tekla grey	1	20	
		<input checked="" type="checkbox"/> <b>44PJTC4GTKT</b> Grigio antracite Anthracite grey	1	20	
		<input checked="" type="checkbox"/> <b>44PJTC4NAL</b> Nero assoluto Absolute black	1	20	
		<input checked="" type="checkbox"/> <b>44PJTC4SA</b> Sabbia Sand	1	20	
		<input checked="" type="checkbox"/> <b>44PJTC4SAL</b> Salvia Sage	1	20	
		<input type="checkbox"/> <b>44PJTC4B/3D</b> Bianco 3D 3D white	1	20	
		<input checked="" type="checkbox"/> <b>44PJTC4BEG/3D</b> Beige spazzolato 3D 3D brushed beige	1	20	
		<input checked="" type="checkbox"/> <b>44PJTC4CBC/3D</b> Carbon chiaro 3D 3D clear carbon	1	20	
		<input checked="" type="checkbox"/> <b>44PJTC4CBS/3D</b> Carbon scuro 3D 3D dark carbon	1	20	
		<input checked="" type="checkbox"/> <b>44PJTC4ONC/3D</b> Onice 3D 3D onyx	1	20	

Sistema 45

Supporto da utilizzare  
To be used with

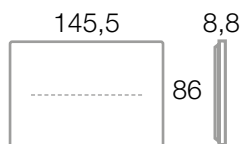

**Nota:** assicurarsi che la placca sia perfettamente aderente agli apparecchi di comando "a scomparsa"  
**Note:** make sure that the front plate sticks perfectly to the "hidden" control devices



# Placche

## Front Plates

NEW WIRING ACCESSORIES

Placche "Young Touch" in tecnopolimero per scatola 6-7 moduli (interasse 158,5 mm)  
 "Young Touch" moulded front plates for rectangular 6-7 modules box (fixing centres 158,5 mm)

232

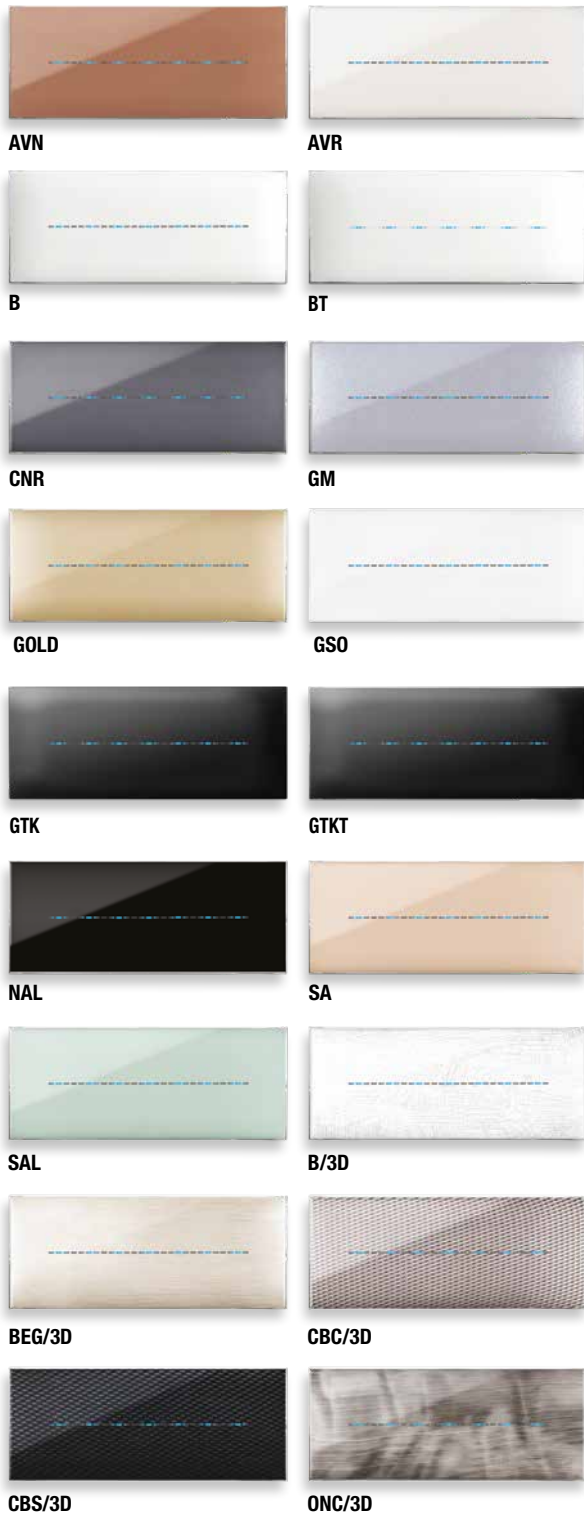

Supporto da utilizzare  
To be used with



44A07

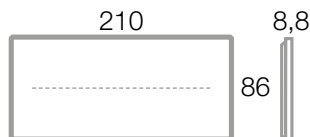

Descrizione Description

Info

€

□

□

Fino a 7 comandi "a scomparsa"  
Up to 7 "hidden" controls

■ 44PJTC7AVN Avana Havana	1	15
■ 44PJTC7AVR Avorio Ivory	1	15
□ 44PJTC7B Bianco White	1	15
□ 44PJTC7BT Bianco totale Total white	1	15
■ 44PJTC7CNR Cenere Ash	1	15
■ 44PJTC7GM Grigio metallizzato Metallic grey	1	15
■ 44PJTC7GOLD Oro Gold	1	15
□ 44PJTC7GSO Gesso Plaster	1	15
■ 44PJTC7GTK Grigio Tekla Tekla grey	1	15
■ 44PJTC7GTKT Grigio antracite Anthracite grey	1	15
■ 44PJTC7NAL Nero assoluto Absolute black	1	15
■ 44PJTC7SA Sabbia Sand	1	15
■ 44PJTC7SAL Salvia Sage	1	15
□ 44PJTC7B/3D Bianco 3D 3D white	1	15
■ 44PJTC7BEG/3D Beige spazzolato 3D 3D brushed beige	1	15
■ 44PJTC7CBC/3D Carbon chiaro 3D 3D clear carbon	1	15
■ 44PJTC7CBS/3D Carbon scuro 3D 3D dark carbon	1	15
■ 44PJTC7ONC/3D Onice 3D 3D onyx	1	15

**Nota:** assicurarsi che la placca sia perfettamente aderente agli apparecchi di comando "a scomparsa"

**Note:** make sure that the front plate sticks perfectly to the "hidden" control devices



Per la disponibilità contattare la rete commerciale  
For availability please contact sales dept.



Disponibilità fino ad esaurimento scorte  
Available until stock out





Prodotto per scatola rettangolare inglese  
Product for British standard rectangular box



Prodotto per Export  
For Export only

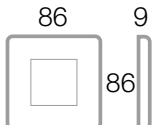

Placche in **plastica** "Young 44" per scatola tonda o quadrata  
 "Young 44" **moulded front plates** for round or square box

2 MODULI 2 MODULES	Cod. Code	Colore Colour	Info	€	□	□
    <p>Supporto da utilizzare To be used with</p>   <p>44A02 44A02SG 44A02VT</p>	44PJ32AVN	Avana <i>Havana</i>	1	25		
	44PJ32AVR	Avorio <i>Ivory</i>	1	25		
	44PJ32B	Bianco <i>White</i>	1	25		
	44PJ32B/3D	Bianco 3D <i>3D white</i>	1	25		
	44PJ32BEG/3D	Beige spazzolato 3D <i>3D brushed beige</i>	1	25		
	44PJ32BT	Bianco totale <i>Total white</i>	1	25		
	44PJ32CBC/3D	Carbon chiaro 3D <i>3D carbon clear</i>	1	25		
	44PJ32CBS/3D	Carbon scuro 3D <i>3D carbon dark</i>	1	25		
	44PJ32CNR	Cenere <i>Ash</i>	1	25		
	44PJ32GM	Grigio metallizzato <i>Metallic grey</i>	1	25		
	44PJ32GOLD	Oro <i>Gold</i>	1	25		
	44PJ32GSO	Gesso <i>Plaster</i>	1	25		
	44PJ32GTK	Grigio Tekla <i>Tekla grey</i>	1	25		
	44PJ32GTKT	Grigio antracite <i>Anthracite grey</i>	1	25		
	44PJ32NAL	Nero assoluto <i>Absolute black</i>	1	25		
	44PJ32ONC/3D	Onice 3D <i>3D onyx</i>	1	25		
44PJ32SA	Sabbia <i>Sand</i>	1	25			
44PJ32SAL	Salvia <i>Sage</i>	1	25			

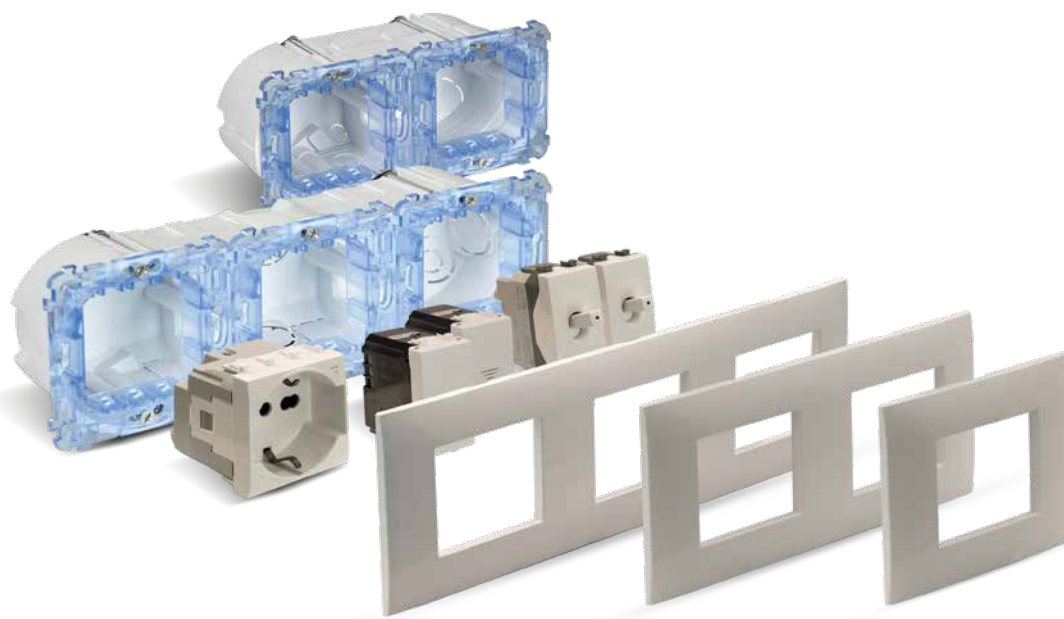

Le dimensioni, salvo diversamente specificato, sono in mm  
 Dimensions, except where otherwise specified, are in mm

□ Imballo Minimo pcs  
 Min. Packaging pcs

□ Imballo Standard pcs  
 Std. Packaging pcs



**Caratteristiche Tecniche** *Technical Features*

	<p><b>Scatole Boxes</b></p>	<p><b>Supporti accoppiabili</b> <i>Frames that can be coupled</i></p> <p>n° 2 44A02 n° 2 44A02SG n° 2 44A02VT</p>
	<p><b>Scatole Boxes</b></p> <p><b>Standard Export</b>      2502      2501      2501P</p>	<p><b>Supporti accoppiabili</b> <i>Frames that can be coupled</i></p> <p>n° 2 44A02 n° 2 44A02SG n° 2 44A02VT</p>
	<p><b>Scatole Boxes</b></p> <p><b>Standard Export</b>      2502      2501      2501P</p>	<p><b>Supporti accoppiabili</b> <i>Frames that can be coupled</i></p> <p>n° 3 44A02 n° 3 44A02SG n° 3 44A02VT</p>
	<p><b>Scatole Boxes</b></p> <p>2502      2501      2501P</p>	<p><b>Supporti accoppiabili</b> <i>Frames that can be coupled</i></p> <p>n° 4 44A02 n° 4 44A02SG n° 4 44A02VT</p>

Per la disponibilità contattare la rete commerciale  
For availability please contact sales dept.

Disponibilità fino ad esaurimento scorte  
Available until stock out

# Prodotto per scatola rettangolare inglese  
Product for British standard rectangular box

Prodotto per Export  
For Export only



Placche in **plastica** "Young 44" per scatola tonda o quadrata  
 "Young 44" **moulded** front plates for round or square box

4(2+2) MODULI 4(2+2) MODULES	Cod. Code	Colore Colour	Info	€	<input type="checkbox"/>	<input type="checkbox"/>
	44PJ34BT	Bianco totale Total white			1	1
	44PJ34GM	Grigio metallizzato Metallic grey			1	1
	44PJ34GOLD	Oro Gold			1	1
	44PJ34GTK	Grigio Tekla Tekla grey			1	1

Soluzione Installativa Installation solution

Supporto da utilizzare  
To be used with

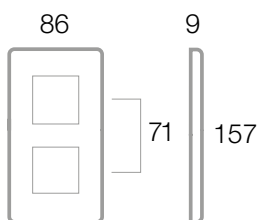

44A02  
44A02SG  
44A02VT



Placca  
Front plate

Placche in **plastica** "Young 44" per scatola tonda o quadrata  
 "Young 44" **moulded** front plates for round or square box

6(2+2+2) MODULI 6(2+2+2) MODULES	Cod. Code	Colore Colour	Info	€	<input type="checkbox"/>	<input type="checkbox"/>
	44PJ36BT	Bianco totale Total white			1	1
	44PJ36GM	Grigio metallizzato Metallic grey			1	1
	44PJ36GOLD	Oro Gold			1	1
	44PJ36GTK	Grigio Tekla Tekla grey			1	1

Soluzione Installativa Installation solution

Supporto da utilizzare  
To be used with

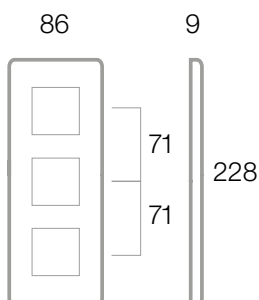

44A02  
44A02SG  
44A02VT



Placca  
Front plate



# Placche

## Front Plates

NEW WIRING ACCESSORIES

Placche in **plastica** "Young 44" per scatola tonda o quadrata  
 "Young 44" **moulded** front plates for round or square box



236

YOUNG 44	Cod. Code	Colore Colour	Info	€	□	□
	44PJ38BT	Bianco totale 2+2+2+2 moduli <i>Total white</i> <i>2+2+2+2 modules</i>			1	1
	44PJ38GM	Grigio metallizzato 2+2+2+2 moduli <i>Metallic grey</i> <i>2+2+2+2 modules</i>			1	1
	44PJ38GOLD	Oro 2+2+2+2 moduli <i>Gold</i> <i>2+2+2+2 modules</i>			1	1
	44PJ38GTK	Grigio Tekla 2+2+2+2 moduli <i>Tekla grey</i> <i>2+2+2+2 modules</i>			1	1

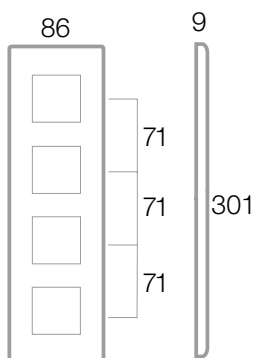

Supporto da utilizzare  
*To be used with*



44A02  
 44A02SG  
 44A02VT



Per la disponibilità contattare  
 la rete commerciale  
 For availability please contact  
 sales dept.



Disponibilità fino ad  
 esaurimento scorte  
 Available until stock out



Prodotto per scatola  
 rettangolare inglese  
 Product for British standard  
 rectangular box



Prodotto  
 per Export  
 For Export  
 only

Placche in **plastica** "Young 44" per scatola rettangolare  
 "Young 44" **moulded** front plates for rectangular box

3 MODULI 3 MODULES	Cod. Code	Colore Colour	Info	€	□	□
	44PJ03AVN	Avana <i>Havana</i>			1	25
	44PJ03AVR	Avorio <i>Ivory</i>			1	25
	44PJ03B	Bianco <i>White</i>			1	25
	44PJ03B/3D	Bianco 3D <i>3D white</i>			1	25
	44PJ03BEG/3D	Beige spazzolato 3D <i>3D brushed beige</i>			1	25
	44PJ03BT	Bianco totale <i>Total white</i>			1	25
	44PJ03CBC/3D	Carbon chiaro 3D <i>3D carbon clear</i>			1	25
	44PJ03CBS/3D	Carbon scuro 3D <i>3D carbon dark</i>			1	25
	44PJ03CNR	Cenere <i>Ash</i>			1	25
	44PJ03GM	Grigio metallizzato <i>Metallic grey</i>			1	25
	44PJ03GOLD	Oro <i>Gold</i>			1	25
	44PJ03GSO	Gesso <i>Plaster</i>			1	25
	44PJ03GTK	Grigio Tekla <i>Tekla grey</i>			1	25
	44PJ03GTKT	Grigio antracite <i>Anthracite grey</i>			1	25
	44PJ03NAL	Nero assoluto <i>Absolute black</i>			1	25
	44PJ03ONC/3D	Onice 3D <i>3D onyx</i>			1	25
44PJ03SA	Sabbia <i>Sand</i>			1	25	
44PJ03SAL	Salvia <i>Sage</i>			1	25	

237

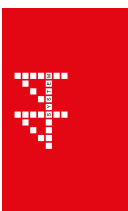

Sistema 45

Supporto da utilizzare  
 To be used with

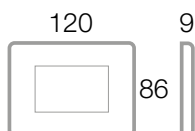

44A03



# Placche

## Front Plates



Placche in **plastica** "Young 44" per scatola rettangolare  
 "Young 44" **moulded** front plates for rectangular box

238

4 MODULI 4 MODULES

Cod. Code Colore Colour

Info € □ □



44PJ04AVN	Avana Havana	1	20
44PJ04AVR	Avorio Ivory	1	20
44PJ04B	Bianco White	1	20
44PJ04B/3D	Bianco 3D 3D white	1	20
44PJ04BEG/3D	Beige spazzolato 3D 3D brushed beige	1	20
44PJ04BT	Bianco totale Total white	1	20
44PJ04CBC/3D	Carbon chiaro 3D 3D carbon clear	1	20
44PJ04CBS/3D	Carbon scuro 3D 3D carbon dark	1	20
44PJ04CNR	Cenere Ash	1	20
44PJ04GM	Grigio metallizzato Metallic grey	1	20
44PJ04GOLD	Oro Gold	1	20
44PJ04GSO	Gesso Plaster	1	20
44PJ04GTK	Grigio Tekla Tekla grey	1	20
44PJ04GTKT	Grigio antracite Anthracite grey	1	20
44PJ04NAL	Nero assoluto Absolute black	1	20
44PJ04ONC/3D	Onice 3D 3D onyx	1	20
44PJ04SA	Sabbia Sand	1	20
44PJ04SAL	Salvia Sage	1	20

Supporto da utilizzare  
To be used with

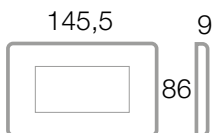

44A04



Per la disponibilità contattare  
la rete commerciale  
For availability please contact  
sales dept.



Disponibilità fino ad  
esaurimento scorte  
Available until stock out



Prodotto per scatola  
rettangolare inglese  
Product for British standard  
rectangular box



Prodotto  
per Export  
For Export  
only

Placche in **plastica** "Young 44" per scatola rettangolare  
 "Young 44" **moulded** front plates for rectangular box

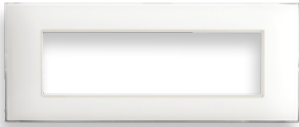
7 MODULI 7 MODULES	Cod. Code	Colore Colour	Info	€	<input type="checkbox"/>	<input type="checkbox"/>
	44PJ07AVN	Avana <i>Havana</i>			1	15
	44PJ07AVR	Avorio <i>Ivory</i>			1	15
	44PJ07B	Bianco <i>White</i>			1	15
	44PJ07B/3D	Bianco 3D <i>3D white</i>			1	15
	44PJ07BEG/3D	Beige spazzolato 3D <i>3D brushed beige</i>			1	15
	44PJ07BT	Bianco totale <i>Total white</i>			1	15
	44PJ07CBC/3D	Carbon chiaro 3D <i>3D carbon clear</i>			1	15
	44PJ07CBS/3D	Carbon scuro 3D <i>3D carbon dark</i>			1	15
	44PJ07CNR	Cenere <i>Ash</i>			1	15
	44PJ07GM	Grigio metallizzato <i>Metallic grey</i>			1	15
	44PJ07GOLD	Oro <i>Gold</i>			1	15
	44PJ07GSO	Gesso <i>Plaster</i>			1	15
	44PJ07GTK	Grigio Tekla <i>Tekla grey</i>			1	15
	44PJ07GTKT	Grigio antracite <i>Anthracite grey</i>			1	15
	44PJ07NAL	Nero assoluto <i>Absolute black</i>			1	15
	44PJ07ONC/3D	Onice 3D <i>3D onyx</i>			1	15
	44PJ07SA	Sabbia <i>Sand</i>			1	15
	44PJ07SAL	Salvia <i>Sage</i>			1	15

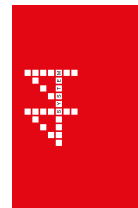

Sistema 45

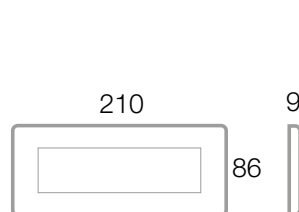

Supporto da utilizzare  
To be used with



44A07

# Placche

## Front Plates

240

I colori delle placche "Tecnopolimero 44" per scatola rettangolare  
"Moulded 44" front plates colours for rectangular box

Plastica Plastic



**44PY03B**  
Bianco RAL 9010  
*RAL 9010 white*



**44PY03SA**  
Sabbia RAL 1013  
*RAL 1013 sand*



**44PY03M**  
Marmo  
*Marble*



**44PY03AO**  
Argento opaco  
*Matt silver*



**44PY03GSL**  
Grigio scuro lucido  
*Polished dark grey*



**44PY03CHO**  
Champagne opaco  
*Matt champagne*



**44PY03GSM**  
Grigio scuro metallizzato  
*Metallic dark grey*



**44PY03GTK**  
Grigio Tekla  
*Tekla grey*



**44PY03RD**  
Radica opaca  
*Matt briarwood*



**44PY03OT**  
Ottone lucido  
*Polished brass*



**44PY03BLC**  
Bianco RAL 9010  
cornice cromata  
*RAL 9010 white  
chrome inner frame*



**44PY03NAL**  
Nero assoluto  
cornice cromata  
*Absolute black  
chrome inner frame*



**44PY03GTKC**  
Grigio Tekla  
cornice cromata  
*Tekla grey  
chrome inner frame*



**44PY03ALS**  
Alluminio naturale  
cornice cromata  
*Natural aluminium  
chrome inner frame*

**I formati placche TECNOPOLIMERO 44**  
*Moulded 44 front plates size*

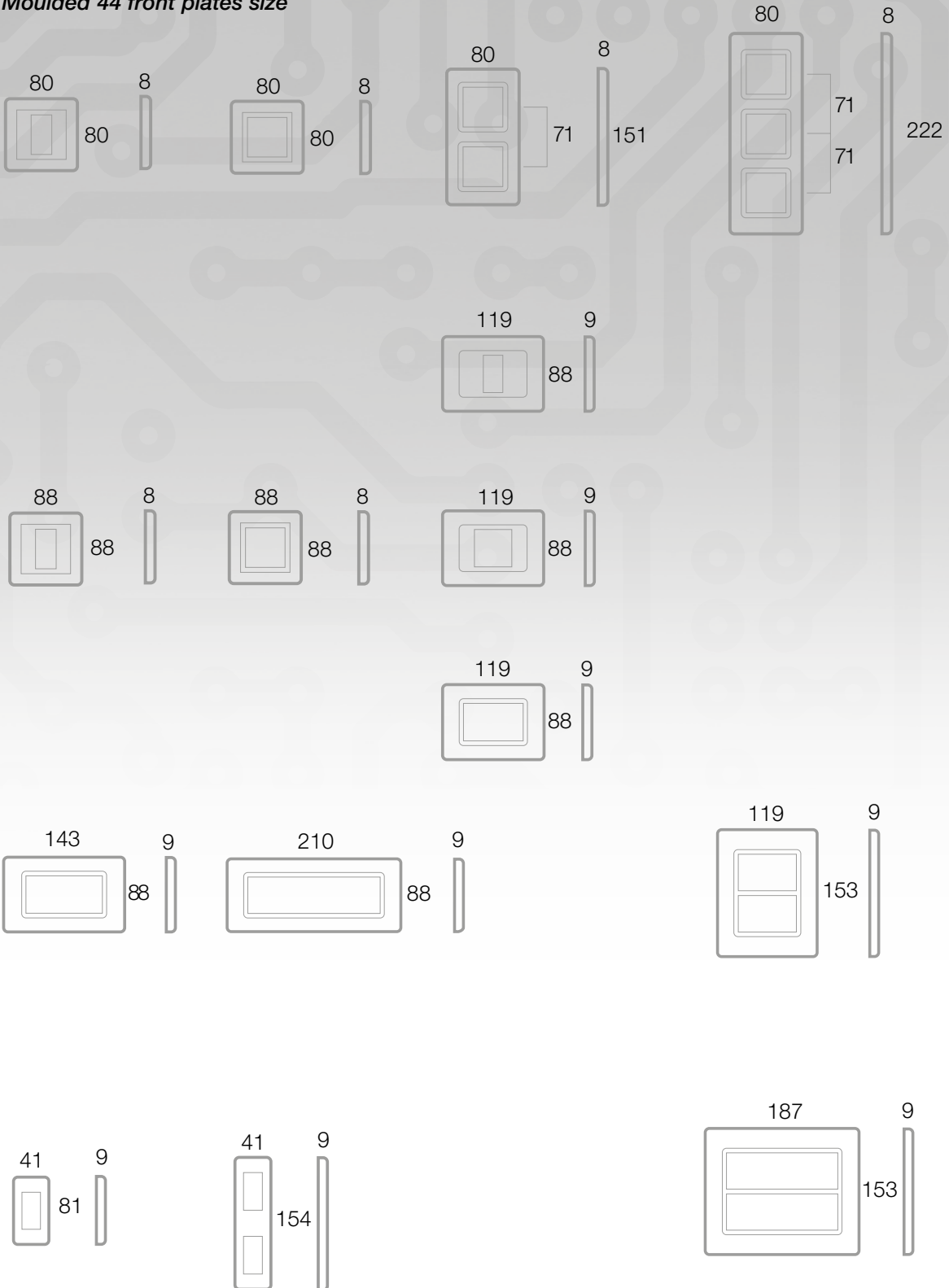



# Placche



## Front Plates



Placche in **plastica** "Tecnopolimero 44" 80x80 mm per scatola tonda o quadrata  
 "Moulded 44" 80x80 mm front plates for square or round box

242

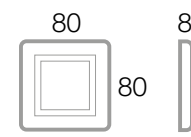
1 MODULO 1 MODULE	Cod. Code	Colore Colour	Info	€	□	□
  Supporto da utilizzare To be used with  44A02 44A02SG 44A02VT	44P31A0	Argento opaco Matt silver			1	30
	44P31AP	Arancione opalino - semitrasparente Opaline orange - semi-transparent			1	30
	44P31B	Bianco Ral 9010 Ral 9010 white			1	30
	44P31GD	Giada opalino - semitrasparente Opaline jade - semi-transparent			1	30
	44P31GSL	Grigio scuro lucido (colore Life Touch) Polished dark grey (Life Touch colour)			1	30
	44P31GSM	Grigio scuro metallizzato Metallic dark grey			1	30
	44P31M	Marmo Marble			1	30
	44P310T	Ottone lucido Polished brass			1	30
	44P31PS	Pesca opalino - semitrasparente Opaline peach - semi-transparent			1	30
	44P31RD	Radica opaca Matt briarwood			1	30
44P31SA	Sabbia Ral 1013 Ral 1013 sand			1	30	

2 MODULI 2 MODULES	Cod. Code	Colore Colour	Info	€	□	□
  Supporto da utilizzare To be used with  44A02 44A02SG 44A02VT	44P32ALS	Alluminio naturale - cornice cromata Natural aluminium - chrome inner frame			1	30
	44P32A0	Argento opaco Matt silver			1	30
	44P32B	Bianco Ral 9010 Ral 9010 white			1	30
	44P32BLC	Bianco Ral 9010 - cornice cromata Ral 9010 white - chrome inner frame			1	30
	44P32GSL	Grigio scuro lucido (colore Life Touch) Polished dark grey (Life Touch colour)			1	30
	44P32GSM	Grigio scuro metallizzato Metallic dark grey			1	30
	44P32GTK	Grigio Tekla Tekla grey			1	30
	44P32GTKC	Grigio Tekla - cornice cromata Tekla grey - chrome inner frame			1	30
	44P32M	Marmo Marble			1	30
	44P32NAL	Nero assoluto - cornice cromata Absolute black - chrome inner frame			1	30
	44P320T	Ottone lucido Polished brass			1	30
	44P32PS	Pesca opalino - semitrasparente Opaline peach - semi-transparent			1	30
	44P32RD	Radica opaca Matt briarwood			1	30
	44P32SA	Sabbia Ral 1013 Ral 1013 sand			1	30



Per la disponibilità contattare la rete commerciale  
For availability please contact sales dept.



Disponibilità fino ad esaurimento scorte  
Available until stock out



Prodotto per scatola rettangolare inglese  
Product for British standard rectangular box



Prodotto per Export  
For Export only



Placche in **plastica** "Tecnopolimero 44" per scatola tonda o quadrata  
 "44 moulded" front plates for square or round box

4(2+2) MODULI 4(2+2) MODULES	Cod. Code	Colore Colour	Info	€	<input type="checkbox"/>	<input type="checkbox"/>
	44P34ALS	Alluminio naturale - cornice cromata <i>Natural aluminium - chrome inner frame</i>		1	15	
	44P34A0	Argento opaco <i>Matt silver</i>		1	15	
	44P34AP	Arancione opalino - semitrasparente <i>Opaline orange - semi-transparent</i>		1	15	
	44P34B	Bianco Ral 9010 <i>Ral 9010 white</i>		1	15	
	44P34BLC	Bianco Ral 9010 - cornice cromata <i>Ral 9010 white - chrome inner frame</i>		1	15	
	44P34GD	Giada opalino - semitrasparente <i>Opaline jade - semi-transparent</i>		1	15	
	44P34GSL	Grigio scuro lucido (colore Life Touch) <i>Polished dark grey (Life Touch colour)</i>		1	15	
	44P34GSM	Grigio scuro metallizzato <i>Metallic dark grey</i>		1	15	
	44P34GTK	Grigio Tekla <i>Tekla grey</i>		1	15	
	44P34GTKC	Grigio Tekla - cornice cromata <i>Tekla grey - chrome inner frame</i>		1	15	
	44P34M	Marmo <i>Marble</i>		1	15	
	44P34NAL	Nero assoluto - cornice cromata <i>Absolute black - chrome inner frame</i>		1	15	
	44P34OT	Ottone lucido <i>Polished brass</i>		1	15	
	44P34PS	Pesca opalino - semitrasparente <i>Opaline peach - semi-transparent</i>		1	15	
	44P34RD	Radica opaca <i>Matt briarwood</i>		1	15	
	44P34SA	Sabbia Ral 1013 <i>Ral 1013 sand</i>		1	15	

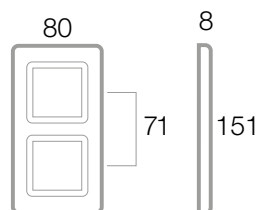

Supporto da utilizzare  
To be used with



n° 3 44A02  
n° 3 44A02SG  
n° 3 44A02VT

Soluzione Installativa *Installation solution*

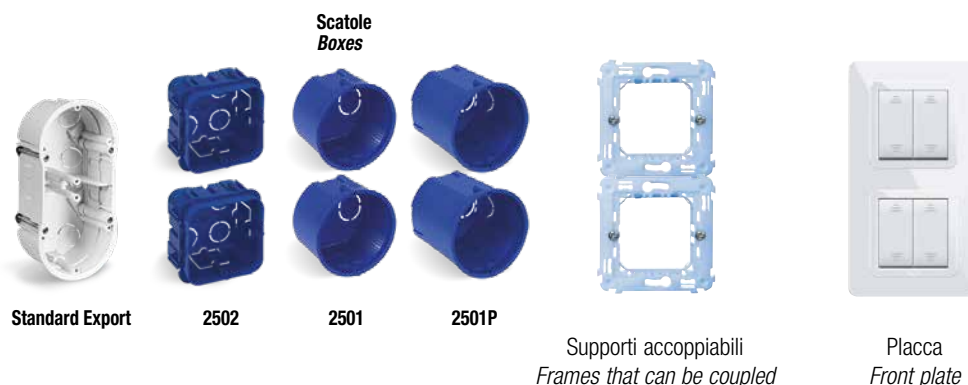

Le dimensioni, salvo diversamente specificato, sono in mm  
Dimensions, except where otherwise specified, are in mm

Imballo Minimo pcs  
Min. Packaging pcs

Imballo Standard pcs  
Std. Packaging pcs



# Placche

## Front Plates



Placche in **plastica** "Tecnopolimero 44" per scatola tonda o quadrata  
 "44 moulded" front plates for square or round box

244

6(2+2+2) MODULI 6(2+2+2) MODULES

Cod. Code Colore Colour

Info € □ □



44P36ALS	Alluminio naturale - cornice cromata <i>Natural aluminium - chrome inner frame</i>	1	10
44P36A0	Argento opaco <i>Matt silver</i>	1	10
44P36AP	Arancione opalino - semitrasparente <i>Opaline orange - semi-transparent</i>	1	10
44P36B	Bianco Ral 9010 <i>Ral 9010 white</i>	1	10
44P36BLC	Bianco Ral 9010 - cornice cromata <i>Ral 9010 white - chrome inner frame</i>	1	10
44P36GD	Giada opalino - semitrasparente <i>Opaline jade - semi-transparent</i>	1	10
44P36GSL	Grigio scuro lucido (colore Life Touch) <i>Polished dark grey (Life Touch colour)</i>	1	10
44P36GSM	Grigio scuro metallizzato <i>Metallic dark grey</i>	1	10
44P36GTK	Grigio Tekla <i>Tekla grey</i>	1	10
44P36GTKC	Grigio Tekla - cornice cromata <i>Tekla grey - chrome inner frame</i>	1	10
44P36M	Marmo <i>Marble</i>	1	10
44P36NAL	Nero assoluto - cornice cromata <i>Absolute black - chrome inner frame</i>	1	10
44P360T	Ottone lucido <i>Polished brass</i>	1	10
44P36PS	Pesca opalino - semitrasparente <i>Opaline peach - semi-transparent</i>	1	10
44P36RD	Radica opaca <i>Matt briarwood</i>	1	10
44P36SA	Sabbia Ral 1013 <i>Ral 1013 sand</i>	1	10

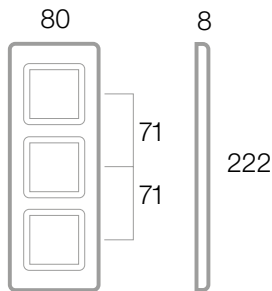

Supporto da utilizzare  
To be used with



n° 3 44A02  
n° 3 44A02SG  
n° 3 44A02VT

Soluzione Installativa Installation solution

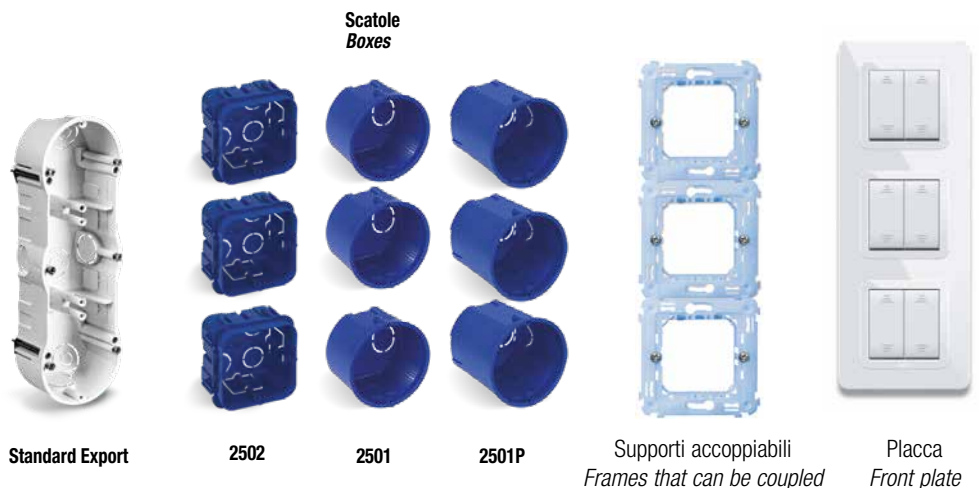

Per la disponibilità contattare  
la rete commerciale  
For availability please contact  
sales dept.



Disponibilità fino ad  
esaurimento scorte  
Available until stock out





Prodotto per scatola  
rettangolare inglese  
Product for British standard  
rectangular box

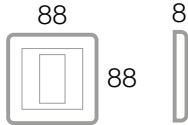

Prodotto  
per Export  
For Export  
only

Placche in **plastica** "Tecnopolimero 44" 88x88 mm per scatola tonda o quadrata  
 "44 moulded" 88x88 mm front plates for square or round box

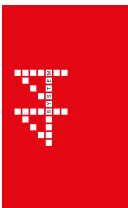

1 MODULO 1 MODULE	Cod. Code	Colore Colour	Info	€	<input type="checkbox"/>	<input type="checkbox"/>
    Supporto da utilizzare To be used with   44A02 44A02SG 44A02VT	44PY31A0	Argento opaco <i>Matt silver</i>			1	10
	44PY31B	Bianco Ral 9010 <i>Ral 9010 white</i>			1	10
	44PY31GD	Giada opalino - semitrasparente <i>Opaline jade - semi-transparent</i>			1	10
	44PY31GSL	Grigio scuro lucido (colore Life Touch) <i>Polished dark grey (Life Touch colour)</i>			1	10
	44PY31GSM	Grigio scuro metallizzato <i>Metallic dark grey</i>			1	10
	44PY31M	Marmo <i>Marble</i>			1	10
	44PY310T	Ottone lucido <i>Polished brass</i>			1	10
	44PY31RD	Radica opaca <i>Matt briarwood</i>			1	10
	44PY31SA	Sabbia Ral 1013 <i>Ral 1013 sand</i>			1	10

245

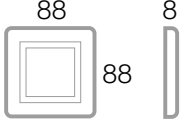

Sistema 45

Placche in **plastica** "Tecnopolimero 44" 88x88 mm per scatola tonda o quadrata  
 "44 moulded" 88x88 mm front plates for square or round box

2 MODULI 2 MODULES	Cod. Code	Colore Colour	Info	€	<input type="checkbox"/>	<input type="checkbox"/>
    Supporto da utilizzare To be used with   44A02 44A02SG 44A02VT	44PY32A0	Argento opaco <i>Matt silver</i>			1	30
	44PY32AP	Arancione opalino - semitrasparente <i>Opaline orange - semi-transparent</i>			1	30
	44PY32B	Bianco Ral 9010 <i>Ral 9010 white</i>			1	30
	44PY32GD	Giada opalino - semitrasparente <i>Opaline jade - semi-transparent</i>			1	30
	44PY32GSL	Grigio scuro lucido (colore Life Touch) <i>Polished dark grey (Life Touch colour)</i>			1	30
	44PY32GSM	Grigio scuro metallizzato <i>Metallic dark grey</i>			1	30
	44PY32M	Marmo <i>Marble</i>			1	30
	44PY320T	Ottone lucido <i>Polished brass</i>			1	30
	44PY32RD	Radica opaca <i>Matt briarwood</i>			1	30
	44PY32SA	Sabbia Ral 1013 <i>Ral 1013 sand</i>			1	30



# Placche

## Front Plates



### Placche in **plastica** "Tecnopolimero 44" per scatola rettangolare "44 moulded" front plates for rectangular box

246

1 MODULO	1 MODULE	Cod. Code	Colore Colour	Info	€	□	□
		44PY01AO	Argento opaco <i>Matt silver</i>			1	25
		44PY01AP	Arancione opalino - semitrasparente <i>Opaline orange - semi-transparent</i>			1	25
		44PY01B	Bianco Ral 9010 <i>Ral 9010 white</i>			1	25
		44PY01GSL	Grigio scuro lucido (colore Life Touch) <i>Polished dark grey (Life Touch colour)</i>			1	25
		44PY01M	Marmo <i>Marble</i>			1	25
		44PY01RD	Radica opaca <i>Matt briarwood</i>			1	25
		44PY01SA	Sabbia Ral 1013 <i>Ral 1013 sand</i>			1	25

Supporto da utilizzare  
To be used with



44A03

### Placche in **plastica** "Tecnopolimero 44" per scatola rettangolare "44 moulded" front plates for rectangular box

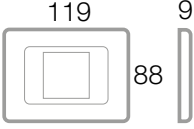
2 MODULI	2 MODULES	Cod. Code	Colore Colour	Info	€	□	□
		44PY02AO	Argento opaco <i>Matt silver</i>			1	25
		44PY02B	Bianco Ral 9010 <i>Ral 9010 white</i>			1	25
		44PY02GSL	Grigio scuro lucido (colore Life Touch) <i>Polished dark grey (Life Touch colour)</i>			1	25
		44PY02M	Marmo <i>Marble</i>			1	25
		44PY02SA	Sabbia Ral 1013 <i>Ral 1013 sand</i>			1	25

Supporto da utilizzare  
To be used with



44A03



Per la disponibilità contattare  
la rete commerciale  
For availability please contact  
sales dept.



Disponibilità fino ad  
esaurimento scorte  
Available until stock out



Prodotto per scatola  
rettangolare inglese  
Product for British standard  
rectangular box



Prodotto  
per Export  
For Export  
only

Placche in **plastica** "Tecnopolimero 44" per scatola rettangolare  
 "44 moulded" front plates for rectangular box

3 MODULI 3 MODULES	Cod. Code	Colore Colour	Info	€	□	□
	44PY03ALS	Alluminio naturale - cornice cromata <i>Natural aluminium - chrome inner frame</i>			1	25
	44PY03AO	Argento opaco <i>Matt silver</i>			1	25
	44PY03B	Bianco Ral 9010 <i>Ral 9010 white</i>			1	25
	44PY03BLC	Bianco Ral 9010 - cornice cromata <i>Ral 9010 white - chrome inner frame</i>			1	25
	44PY03CHO	Champagne opaco <i>Matt champagne</i>			1	25
	44PY03GSL	Grigio scuro lucido (colore Life Touch) <i>Polished dark grey (Life Touch colour)</i>			1	25
	44PY03GSM	Grigio scuro metallizzato <i>Metallic dark grey</i>			1	25
	44PY03GTK	Grigio Tekla <i>Tekla grey</i>			1	25
	44PY03GTKC	Grigio Tekla - cornice cromata <i>Tekla grey - chrome inner frame</i>			1	25
	44PY03M	Marmo <i>Marble</i>			1	25
	44PY03NAL	Nero assoluto - cornice cromata <i>Absolute black - chrome inner frame</i>			1	25
	44PY03OT	Ottone lucido <i>Polished brass</i>			1	25
	44PY03RD	Radica opaca <i>Matt briarwood</i>			1	25
	44PY03SA	Sabbia Ral 1013 <i>Ral 1013 sand</i>			1	25

247

Sistema 45

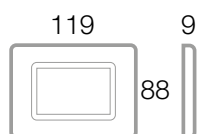

Supporto da utilizzare  
To be used with



44A03



# Placche

## Front Plates



Placche in **plastica** "Tecnopolimero 44" per scatola rettangolare  
 "44 moulded" front plates for rectangular box

248

4 MODULI 4 MODULES

Cod. Code Colore Colour

Info

€

□

□



<b>44PY04ALS</b>	Alluminio naturale - cornice cromata <i>Natural aluminium - chrome inner frame</i>	1	20
<b>44PY04AO</b>	Argento opaco <i>Matt silver</i>	1	20
<b>44PY04B</b>	Bianco Ral 9010 <i>Ral 9010 white</i>	1	20
<b>44PY04BLC</b>	Bianco Ral 9010 - cornice cromata <i>Ral 9010 white - chrome inner frame</i>	1	20
<b>44PY04CHO</b>	Champagne opaco <i>Matt champagne</i>	1	20
<b>44PY04GSL</b>	Grigio scuro lucido (colore Life Touch) <i>Polished dark grey (Life Touch colour)</i>	1	20
<b>44PY04GSM</b>	Grigio scuro metallizzato <i>Metallic dark grey</i>	1	20
<b>44PY04GTK</b>	Grigio Tekla <i>Tekla grey</i>	1	20
<b>44PY04GTKC</b>	Grigio Tekla - cornice cromata <i>Tekla grey - chrome inner frame</i>	1	20
<b>44PY04M</b>	Marmo <i>Marble</i>	1	20
<b>44PY04NAL</b>	Nero assoluto - cornice cromata <i>Absolute black - chrome inner frame</i>	1	20
<b>44PY04OT</b>	Ottone lucido <i>Polished brass</i>	1	20
<b>44PY04RD</b>	Radica opaca <i>Matt briarwood</i>	1	20
<b>44PY04SA</b>	Sabbia Ral 1013 <i>Ral 1013 sand</i>	1	20

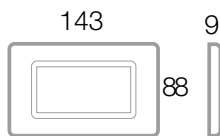

Supporto da utilizzare  
 To be used with



**44A04**



Per la disponibilità contattare  
 la rete commerciale  
 For availability please contact  
 sales dept.



Disponibilità fino ad  
 esaurimento scorte  
 Available until stock out



Prodotto per scatola  
 rettangolare inglese  
 Product for British standard  
 rectangular box



Prodotto  
 per Export  
 For Export  
 only

Placche in **plastica** "Tecnopolimero 44" per scatola rettangolare  
 "44 moulded" front plates for rectangular box

7 MODULI 7 MODULES	Cod. Code	Colore Colour	Info	€	□	□
	44PY07ALS	Alluminio naturale - cornice cromata <i>Natural aluminium - chrome inner frame</i>			1	15
	44PY07AO	Argento opaco <i>Matt silver</i>			1	15
	44PY07B	Bianco Ral 9010 <i>Ral 9010 white</i>			1	15
	44PY07BLC	Bianco Ral 9010 - cornice cromata <i>Ral 9010 white - chrome inner frame</i>			1	15
	44PY07CHO	Champagne opaco <i>Matt champagne</i>			1	15
	44PY07GSL	Grigio scuro lucido (colore Life Touch) <i>Polished dark grey (Life Touch colour)</i>			1	15
	44PY07GSM	Grigio scuro metallizzato <i>Metallic dark grey</i>			1	15
	44PY07GTK	Grigio Tekla <i>Tekla grey</i>			1	15
	44PY07GKTC	Grigio Tekla - cornice cromata <i>Tekla grey - chrome inner frame</i>			1	15
	44PY07M	Marmo <i>Marble</i>			1	15
	44PY07NAL	Nero assoluto - cornice cromata <i>Absolute black - chrome inner frame</i>			1	15
	44PY07OT	Ottone lucido <i>Polished brass</i>			1	15
	44PY07RD	Radica opaca <i>Matt briarwood</i>			1	15
	44PY07SA	Sabbia Ral 1013 <i>Ral 1013 sand</i>			1	15

249

Sistema 45



Supporto da utilizzare  
To be used with



44A07



# Placche

## Front Plates



### Placche in **plastica** "Tecnopolimero 44" per scatola BL02P "44 moulded" front plates for BL02P box

250

6(3+3) MODULI 6(3+3) MODULES

Cod. Code	Colore Colour	Info	€	□	□
44PY033AO	Argento opaco <i>Matt silver</i>			1	5
44PY033B	Bianco Ral 9010 <i>Ral 9010 white</i>			1	5
44PY033CHO	Champagne opaco <i>Matt champagne</i>			1	5
44PY033GSL	Grigio scuro lucido (colore Life Touch) <i>Polished dark grey (Life Touch colour)</i>			1	5
44PY033M	Marmo <i>Marble</i>			1	5
44PY033SA	Sabbia Ral 1013 <i>Ral 1013 sand</i>			1	5



Supporto da utilizzare  
To be used with



44A33

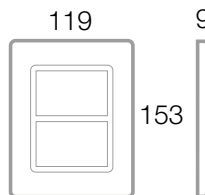

### Placche in **plastica** "Tecnopolimero 44" per scatola BL05P e BL05CG "44 moulded" front plates for BL05P and BL05CG box

12(6+6) MODULI 12(6+6) MODULES

Cod. Code	Colore Colour	Info	€	□	□
44PY012AO	Argento opaco <i>Matt silver</i>			1	5
44PY012B	Bianco Ral 9010 <i>Ral 9010 white</i>			1	5
44PY012CHO	Champagne opaco <i>Matt champagne</i>			1	5
44PY012GSL	Grigio scuro lucido (colore Life Touch) <i>Polished dark grey (Life Touch colour)</i>			1	5
44PY012M	Marmo <i>Marble</i>			1	5



Supporto da utilizzare  
To be used with



44A12

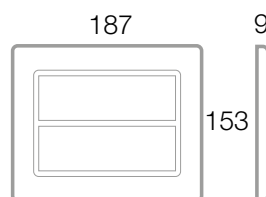

**BL05P**  
Pareti in muratura  
*Brickwork walls*

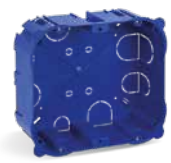

**BL05CG**  
Pareti in cartongesso  
*Hollow walls*



Per la disponibilità contattare  
la rete commerciale  
For availability please contact  
sales dept.



Disponibilità fino ad  
esaurimento scorte  
Available until stock out



Prodotto per scatola  
rettangolare inglese  
Product for British standard  
rectangular box



Prodotto  
per Export  
For Export  
only



Placche in **plastica** "Tecnopolimero 44" per pannelli/profilati  
 "44 moulded" front plates for section bars

1 MODULO	1 MODULE	Cod. Code	Colore Colour	Info	€	<input type="checkbox"/>	<input type="checkbox"/>
		44PF1B	Bianco Ral 9010 <i>Ral 9010 white</i>			1	50
		44PF1CHO	Champagne opaco <i>Matt champagne</i>			1	50
		44PF1GSL	Grigio scuro lucido (colore Life Touch) <i>Polished dark grey (Life Touch colour)</i>			1	50

251

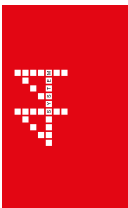

Sistema 45

Supporto da utilizzare  
To be used with



44A01

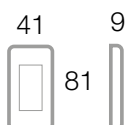

Placche in **plastica** "Tecnopolimero 44" per pannelli/profilati  
 "44 moulded" front plates for section bars

2(1+1) MODULI	2(1+1) MODULES	Cod. Code	Colore Colour	Info	€	<input type="checkbox"/>	<input type="checkbox"/>
		44PF2A0	Argento opaco <i>Matt silver</i>			1	30
		44PF2B	Bianco Ral 9010 <i>Ral 9010 white</i>			1	30
		44PF2M	Marmo <i>Marble</i>			1	30
		44PF2SA	Sabbia Ral 1013 <i>Ral 1013 sand</i>			1	30

Supporto da utilizzare  
To be used with



44A01

+

44A01

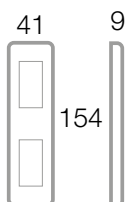

# Placche

## Front Plates

252

I colori delle placche "Personal 44" per scatola rettangolare  
 "Personal 44" front plates colours for rectangular box

Design:  
 L. Merletti

Plastica Plastic



**44P03ALS**  
 Alluminio naturale  
 Natural aluminium



**44P03B**  
 Bianco lucido RAL 9010  
 RAL 9010 polished white



**44P03GRL**  
 Grigio scuro lucido  
 Polished dark grey



**44P03BEL**  
 Beige lucido  
 Polished beige



**44P03CE**  
 Celeste  
 Light blue



**44P03AZB**  
 Azzurro brillante  
 Bright light blue



**44P03NAL**  
 Nero assoluto lucido  
 Polished absolute black



**44P03RPL**  
 Rosso Pompei lucido  
 Polished Pompeian red

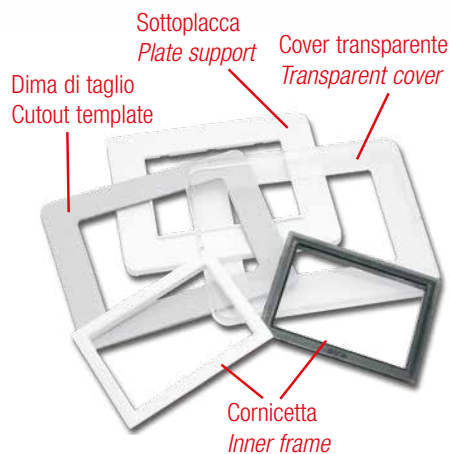

**44P03TR**  
 Placca trasparente personalizzabile (da assemblare)  
 Transparent customizable front plate (to assemble)

Vedere anche schema riportato in placche "Vera 44"  
 See also the scheme in "Vera 44" front plates

**I formati placche PERSONAL 44**  
*PERSONAL 44 front plates size*

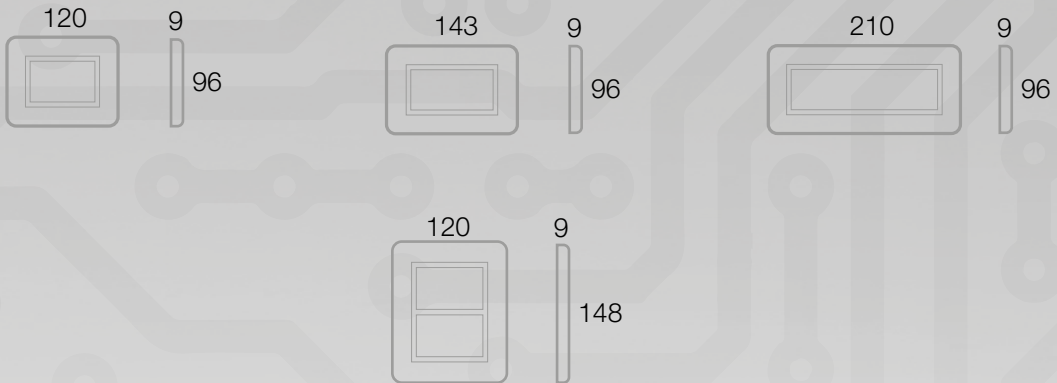

**Installazione Orizzontale e Verticale placche**  
*Horizontal and Vertical front plates installation*

**Nell'esempio 2503MG + BLAS25**  
*In the example 2503MG + BLAS25*

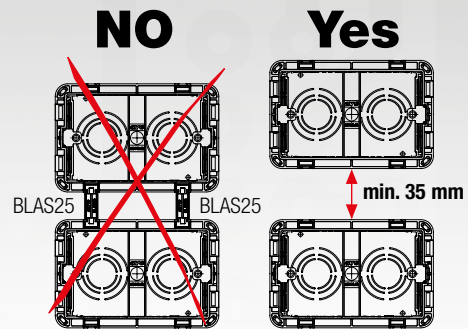
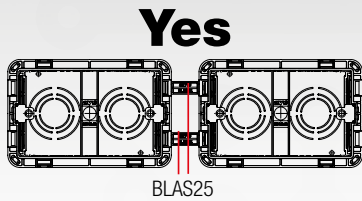

**Esempi di personalizzazioni** *Examples for customization*





# Placche

## Front Plates



### Placche in **plastica** "Personal 44" per scatola rettangolare "Personal 44" **moulded** front plates for rectangular box

254

3 MODULI 3 MODULES



Cod. Code	Colore Colour	Cornicetta Inner frame	Info	€	□	□
44P03ALS	Alluminio naturale Natural aluminium	Cromo Chrome			1	12
44P03AZB	Azzurro brillante Bright light blue	Bianco Ral 9010 Ral 9010 white			1	12
44P03B	Bianco lucido Ral 9010 Ral 9010 polished white	Bianco Ral 9010 Ral 9010 white			1	12
44P03BEL	Beige lucido Polished beige	Bianco Ral 9010 Ral 9010 white			1	12
44P03CE	Celeste Light blue	Bianco Ral 9010 Ral 9010 white			1	12
44P03GRL	Grigio scuro lucido Polished dark grey	Bianco Ral 9010 Ral 9010 white			1	12
44P03NAL	Nero assoluto Absolute black	Cromo Chrome			1	12
44P03RPL	Rosso Pompei Pompeian red	Grigio scuro lucido Polished dark grey			1	12
44P03TR	Trasparente personalizzabile - fornita da assemblare (vedi fig. sotto) Transparent customizable - to be assembled (see below)	Bianco Ral 9010 (in dotazione) Grigio scuro lucido (in dotazione) Ral 9010 white (included) Polished dark grey (included)			1	12

- Note:**
- ✓ 44P03TR diversamente dalla 44P03B viene fornita da assemblare in modo da poter essere personalizzata a cura dell'utente. Infatti oltre a prevedere la doppia cornice (bianco RAL9010 e grigio scuro lucido) viene corredata di una dima di taglio per carta da parati o tappezzeria (vedi figura sotto)
  - ✓ 44P03B stessa colorazione della 44P03TR
  - ✓ 44P03TR differently from 44P03B, has to be assembled in order to allow the customer to personalize it. Two inner frames (RAL9010 and polished dark grey), and the cutout template for wallpaper are included (see below)
  - ✓ 44P03B has the same colour as 44P03TR



#### Modalità Fornitura 44P03TR Conditions of supply 44P03TR

Supporto da utilizzare  
To be used with



44A03

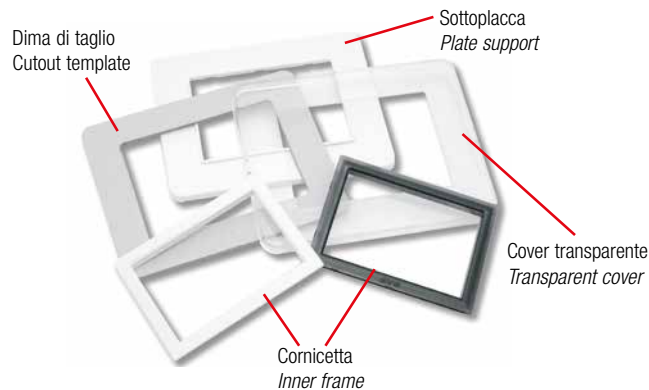

#### Cornicette di ricambio Spare inner frames

Cod. Code	Colore Colour	Info	€	□	□
44CR3B	Bianco Ral 9010 Ral 9010 white			2	50
44CR3N	Grigio scuro lucido Polished dark grey			2	50
44CR3CR	Cromo Chrome			2	50



Per la disponibilità contattare la rete commerciale  
For availability please contact sales dept.



Disponibilità fino ad esaurimento scorte  
Available until stock out



Prodotto per scatola rettangolare inglese  
Product for British standard rectangular box



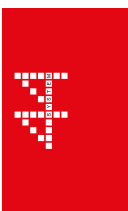

Prodotto per Export  
For Export only

Placche in **plastica** "Personal 44" per scatola rettangolare  
 "Personal 44" **moulded** front plates for rectangular box



Sistema 45

4 MODULI 4 MODULES	Cod. Code	Colore Colour	Cornicetta Inner frame	Info	€	<input type="checkbox"/>	<input type="checkbox"/>
 	44P04ALS	Alluminio naturale Natural aluminium	Cromo Chrome			1	10
	44P04AZB	Azzurro brillante Bright light blue	Bianco Ral 9010 Ral 9010 white			1	10
	44P04B	Bianco lucido Ral 9010 Ral 9010 polished white	Bianco Ral 9010 Ral 9010 white			1	10
	44P04BEL	Beige lucido Polished beige	Bianco Ral 9010 Ral 9010 white			1	10
	44P04GRL	Grigio scuro lucido Polished dark grey	Bianco Ral 9010 Ral 9010 white			1	10
	44P04NAL	Nero assoluto Absolute black	Cromo Chrome			1	10
	44P04RPL	Rosso Pompei Pompeian red	Grigio scuro lucido Polished dark grey			1	10

7 MODULI 7 MODULES	Cod. Code	Colore Colour	Info	€	<input type="checkbox"/>	<input type="checkbox"/>
 	44P07ALS	Alluminio naturale Natural aluminium	Cromo Chrome			1 5
	44P07AZB	Azzurro brillante Bright light blue	Bianco Ral 9010 Ral 9010 white			1 5
	44P07B	Bianco lucido Ral 9010 Ral 9010 polished white	Bianco Ral 9010 Ral 9010 white			1 5
	44P07BEL	Beige lucido Polished beige	Bianco Ral 9010 Ral 9010 white			1 5
	44P07GRL	Grigio scuro lucido Polished dark grey	Bianco Ral 9010 Ral 9010 white			1 5
	44P07NAL	Nero assoluto Absolute black	Cromo Chrome			1 5
	44P07RPL	Rosso Pompei Pompeian red	Grigio scuro lucido Polished dark grey			1 5

Supporto da utilizzare  
To be used with



44A04

Supporto da utilizzare  
To be used with

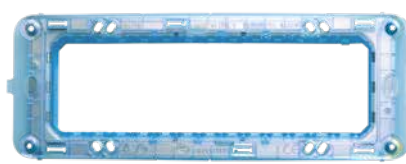

44A07

Cornicette di ricambio Spare inner frames

	Cod. Code	Colore Colour	Info	€	<input type="checkbox"/>	<input type="checkbox"/>
	44CR4B	Bianco Ral 9010 Ral 9010 white			2	50
	44CR4N	Grigio scuro lucido Polished dark grey			2	50
	44CR4CR	Cromo Chrome			2	50
	44CR7B	Bianco Ral 9010 Ral 9010 white			2	30
	44CR7N	Grigio scuro lucido Polished dark grey			2	30
	44CR7CR	Cromo Chrome			2	30

Le dimensioni, salvo diversamente specificato, sono in mm  
 Dimensions, except where otherwise specified, are in mm

Imballo Minimo pcs  
 Min. Packaging pcs

Imballo Standard pcs  
 Std. Packaging pcs



# Placche

## Front Plates



### Placche in **plastica** "Personal 44" per scatola BL02P "Personal 44" *moulded front plates for BL02P box*

256

6(3+3) MODULI 6(3+3) MODULES



Cod. Code	Colore Colour	Cornicetta Inner frame	Info	€	□	□
44P033AB	Arancione brillante <i>Bright orange</i>	Bianco Ral 9010 <i>Ral 9010 white</i>			1	5
44P033ALS	Alluminio naturale <i>Natural aluminium</i>	Cromo <i>Chrome</i>			1	5
44P033AZB	Azzurro brillante <i>Bright light blue</i>	Bianco Ral 9010 <i>Ral 9010 white</i>			1	5
44P033B	Bianco lucido Ral 9010 <i>Ral 9010 polished white</i>	Bianco Ral 9010 <i>Ral 9010 white</i>			1	5
44P033BEL	Beige lucido <i>Polished beige</i>	Bianco Ral 9010 <i>Ral 9010 white</i>			1	5
44P033GRL	Grigio scuro lucido <i>Polished dark grey</i>	Bianco Ral 9010 <i>Ral 9010 white</i>			1	5
44P033NAL	Nero assoluto <i>Absolute black</i>	Cromo <i>Chrome</i>			1	5
44P033RPL	Rosso Pompei <i>Pompeian red</i>	Grigio scuro lucido <i>Polished dark grey</i>			1	5

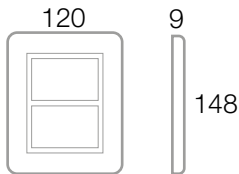

Supporto da utilizzare  
*To be used with*



44A33

Scatola da utilizzare  
*To be used with*



BL02P

Pareti in muratura  
*Brickwork walls*



BL02CG

Pareti in cartongesso  
*Hollow walls*

Prodotti Installabili  
*Product to be installed*



TS01

Touch Screen  
4,3"



44.AP01

Diffusore acustico  
*Loudspeaker*

### Cornicette di ricambio *Spare inner frames*



Cod. Code	Colore Colour	Info	€	□	□
44CR33B	Bianco Ral 9010 <i>Ral 9010 white</i>			2	50
44CR33N	Grigio scuro lucido <i>Polished dark grey</i>			2	50
44CR33CR	Cromo <i>Chrome</i>			2	50
44CR33CR/AP	Cromo - versione senza traversino centrale da utilizzare con diffusori sonori 441AP01 o 442AP01 <i>Chrome - version without central cross bar to be used with 441AP01 or 442AP01 loudspeakers</i>			2	50



Per la disponibilità contattare  
la rete commerciale  
For availability please contact  
sales dept.



Disponibilità fino ad  
esaurimento scorte  
Available until stock out



Prodotto per scatola  
rettangolare inglese  
Product for British standard  
rectangular box



Prodotto  
per Export  
For Export  
only



**Accessori e strumenti promozionali**  
*Promotional accessories and instruments*

257



Cod. Code	Descrizione Description	Info	€	<input type="checkbox"/>	<input type="checkbox"/>
<b>SWPERSONAL44</b>	Software per personalizzazione placche "Personal 44" <i>Software to customize "Personal 44" plates</i>		-	-	
<b>PERSONAL/3M</b>	Set da 30 cartoncini personalizzabili - 3 moduli <i>Set of 30 customizable cards - 3 modules</i>		1	1	
<b>PERSONAL/VM</b>	Set da 30 cartoncini personalizzabili - 4 moduli, 7 moduli, 6(3+3) moduli <i>Set of 30 customizable cards - 4 modules, 7 modules, 6(3+3) modules</i>		1	1	

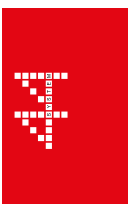

Sistema 45

**SWPERSONAL44**



**PERSONAL/3M**



**PERSONAL/VM**

**Software di personalizzazione delle placche PERSONAL 44**  
*PERSONAL 44 front plates customization software*



Le dimensioni, salvo diversamente specificato, sono in mm  
 Dimensions, except where otherwise specified, are in mm

Imballo Minimo pcs  
 Min. Packaging pcs

Imballo Standard pcs  
 Std. Packaging pcs





# Serie Civili

# Sistema 44

System 44  
Wiring Accessories

SERIE CIVILI  
WIRING ACCESSORIES



259

Sistema 44  
44 System

Soluzioni Ave Touch  
Ave Touch solutions

**269**

Configuratore  
Configurator

**269**

Placche Multimodulo  
Multi-module front plates

**273**



**Nuovo sistema di personalizzazione delle placche**  
*New customization system of front plates*

**visita il sito**  
*visit the website*  
<https://avexclusive.ave.it>

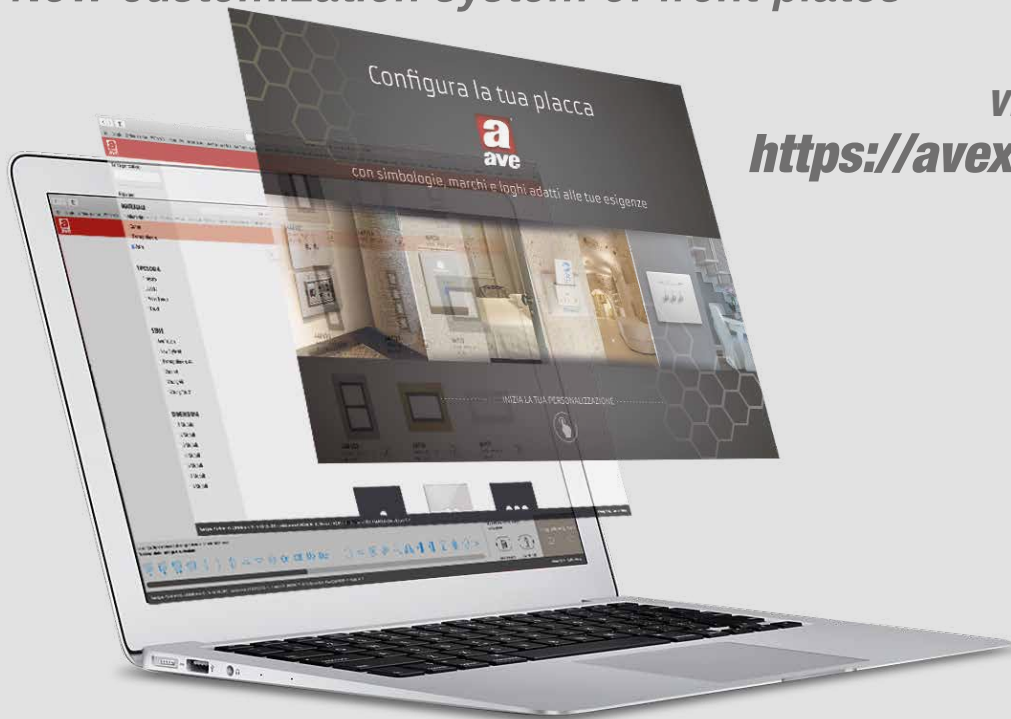

**Caratteristiche Tecniche** *Technical Features*

**Personalizzazione delle placche ti permette:**

- **scelta dei materiali**
- **tipologia e dimensioni**
- **scelta dei colori**
- **caricare le tue immagini personalizzate**
- **un carrello sempre a disposizione**
- **invio della richiesta per e-mail**
- **stampa digitale, incisione laser**
- **..... e molto altro ancora**

**The customization system allows:**

- **Material selection**
- **Type and dimensions selection**
- **Colours choice**
- **Loading of customizable images**
- **Your basket always available**
- **Sending the request by email**
- **digital print, laser engraving**
- **.... and much more**

**Tecniche di personalizzazione**  
*Customization techniques*



**Personalizzazione su placca in vetro tramite LASER**  
*Customization on glass front plate by laser*



**Personalizzazione tramite stampa Digitale**  
*Customization by digital print*

# Configuratore placche personalizzate

## Customizable front plates configurator



Design:  
B. Dall'Eco  
L. Merletti

261

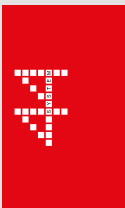

Sistema 45



In pochi passaggi personalizza la tua placca  
*In just a few steps, customize your front plate*

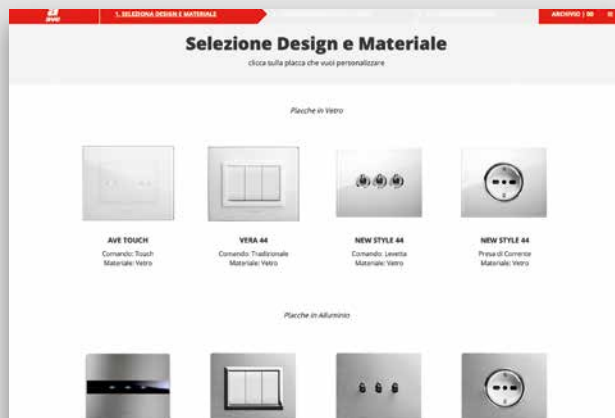

scegli il design e materiale desiderato...  
*choose the desired design and material ...*



...seleziona il tuo modello di placca...  
*... select your front plate model ...*



...trascina il tuo logo e vedi subito l'anteprima della tua personalizzazione....  
*... drag your logo and immediately see the preview of your customization*

**SALVA**, la personalizzazione viene salvata nel tuo archivio personale e non inviata nel backoffice. Per l'invio utilizza il tasto **CONFERMA**.

**SAVE** the personalization it is saved in your personal archive and not sent to the back office. To send click on the **CONFIRM** button

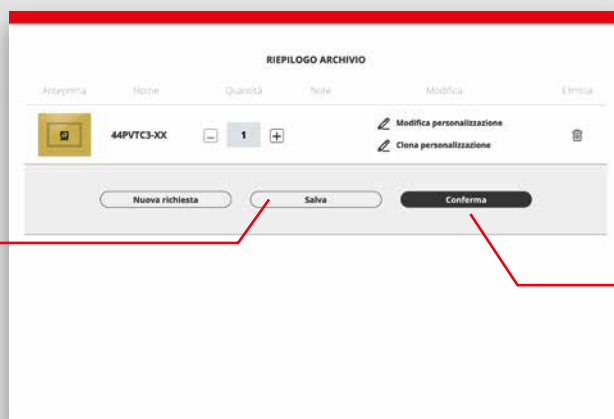

**CONFERMA**, la tua personalizzazione viene inviata nel backoffice quindi in lavorazione.

**CONFIRM**, your customization is sent to the back office and it is then being processed

.. non ti resta che **CONFERMARE** per mandare in lavorazione la tua placca personalizzata.  
*.. you just have to CONFIRM to process your customized front plate order*



# Configuratore placche personalizzate

## Customizable front plates configurator



Simbologie disponibili  
Available symbols

Caratteristiche Tecniche Technical Features

1	2	3	4	5	6	7	8	9	10	11	12
13	14	15	16	17	18	19	20	21	22	23	24
25	26	27	28	29	30	31	32	33	34	35	36
37	38	39	40	41	42	43	44	45	46	47	48
49	50	51	52	53	54	55	56	57	58	59	60
61	62	63	63	65	66	67	68	69	70	71	72
73	74	75	76	77	78	79	80	81	82	83	84
85	86	87	88	89	90	91	92	93	94	95	96
97	98	99	100	101	102	103	104	105	106	107	108
109	110	111	112	113	114	115	116	117	118	119	120

Font per numeri stanza placche alberghiero  
Font for hotel front plates room numbers

Subway Ticker Regular

1	2	3	4	5	6	7	8	9	0
---	---	---	---	---	---	---	---	---	---

Times New Roman Regular

1	2	3	4	5	6	7	8	9	0
---	---	---	---	---	---	---	---	---	---



# Prezzi personalizzazione

## Customization prices

### Configuratore placche personalizzate

#### Customizable front plates configurator



Ave offre la possibilità tramite configuratore disponibile sul sito [www.ave.it](http://www.ave.it) di personalizzare la gamma di placche.

I prezzi della personalizzazione riportati nelle tabelle, sono da dividere per il numero di placche aventi la stessa personalizzazione e aventi gli stessi moduli. In caso di variazione dei moduli della placca, colore o tipologia, dovrà essere ricalcolato il prezzo da ripartire sulla nuova tipologia di placca. Tale prezzo di personalizzazione sarà da aggiungere al prezzo della placca standard scelta. Disponibili nelle pagine successive le placche in vetro completamente personalizzabili, senza cornicetta e comando standard ■■■ con codice finale /XX.

In caso di personalizzazione con entrambe le tipologie, loghi e simboli, andranno sommati i prezzi di entrambe le tabelle, sempre da distribuire sul numero di pezzi.

Per la fattibilità, tempi e costi di tutte le altre personalizzazioni non presenti nel nuovo configuratore, ad esempio colore speciale della placca, contattare la rete commerciale Ave.

*Ave offers the possibility to customize the range of front plates through the configurator available on the website [www.ave.it](http://www.ave.it).*

*The prices of the customization shown in the tables are to be divided by the number of front plates having the same customization and having the same modules. In case of change in the modules, the colour or the type of the front plate, the price to be divided on the new type of front plate must be recalculated. This customization price will be added to the price of the chosen standard front plate. In the following pages the completely customizable glass plates without inner frame and standard control ■■■ are available with final code / XX.*

*In case of customization with both types, logos and symbols, the prices of both tables will be added together, always to be distributed over the number of pieces. For the feasibility, times and prices of all other customizations not present in the new configurator, for example special front plate colour, contact the AVE sales network.*

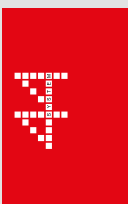

Sistema 45

#### Tabelle prezzi

#### Simbologia da libreria, da distribuire sul numero di pezzi:

##### Price tables

##### Library symbols, to be distributed over the number of pieces:

Quantità Quantity	Prezzi Price
<b>Fino a 20 pezzi</b> Until 20 pcs	<b>Netto 15€</b> Net 15€
<b>Da 21 pz. a 50 pezzi</b> From 21 pcs to 50 pcs	<b>Netto 10€</b> Net 10€
<b>Da 51 pz. a 100 pezzi</b> From 51 pcs to 100 pcs	<b>Netto 6€</b> Net 6€

#### Loghi / immagini, caricati

#### da distribuire sul numero di pezzi:

##### Loaded logos / images,

##### to be distributed over the number of pieces

Per singola personalizzazione Single customization	prezzo netto 250 € Net price € 250
---	---------------------------------------

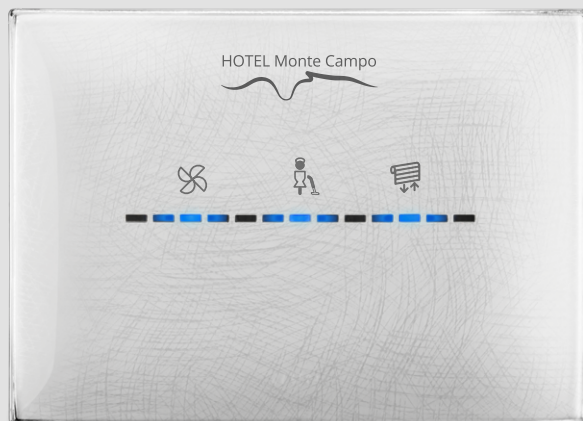
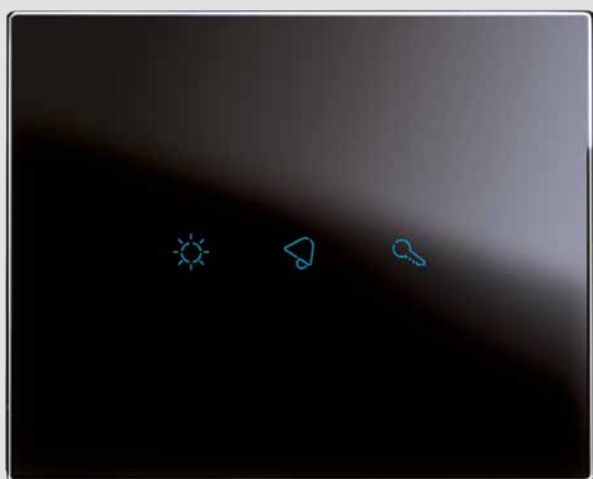



# Placche personalizzabili

Customizable front plates



Placche "Ave Touch" in vetro per scatola tonda o quadrata - PERSONALIZZABILI

"Ave Touch" glass front plates for round or square box - CUSTOMIZABLE

264



44PVT22NAL/XX

Descrizione Description

Info

€

□

□

□ 44PVT22BL/XX

Bianco Lucido - 2 moduli

Clear White - 2 modules

a commessa  
upon request

1

1

■ 44PVT22GO/XX

Grigio argentato finitura opaca - 2 moduli

Frosted silver grey - 2 modules

a commessa  
upon request

1

1

■ 44PVT22GOLD/XX

Oro finitura lucida - 2 moduli

Frosted gold - 2 modules

a commessa  
upon request

1

1

■ 44PVT22NAL/XX

Nero assoluto finitura lucida - 2 moduli

Clear absolute black - 2 modules

a commessa  
upon request

1

1

■ 44PVT22VO/XX

Verde Acqua finitura opaca - 2 moduli

Frosted water green - 2 modules

a commessa  
upon request

1

1

Nota: per ulteriori informazioni vedere pag. 106

Note: for further information see page 106

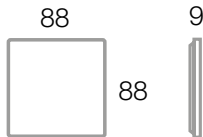

Placche "Ave Touch" in vetro per scatola 3 moduli (interasse 83,5 mm) - PERSONALIZZABILI

"Ave Touch" glass front plates for rectangular 3 modules box (fixing centres 83,5 mm) - CUSTOMIZABLE



44PVT3NAL/XX

Descrizione Description

Info

€

□

□

□ 44PVT3BL/XX

Bianco Lucido - 3 moduli

Clear White - 3 modules

a commessa  
upon request

1

1

■ 44PVT3GO/XX

Grigio argentato finitura opaca - 3 moduli

Frosted silver grey - 3 modules

a commessa  
upon request

1

1

■ 44PVT3GOLD/XX

Oro finitura lucida - 3 moduli

Frosted gold - 3 modules

a commessa  
upon request

1

1

■ 44PVT3NAL/XX

Nero assoluto finitura lucida - 3 moduli

Clear absolute black - 3 modules

a commessa  
upon request

1

1

■ 44PVT3VO/XX

Verde Acqua finitura opaca - 3 moduli

Frosted water green - 3 modules

a commessa  
upon request

1

1

Nota: per ulteriori informazioni vedere pag. 106

Note: for further information see page 106

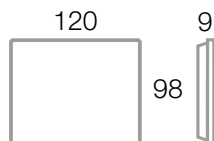

Per la disponibilità contattare la rete commerciale  
For availability please contact sales dept.



Disponibilità fino ad esaurimento scorte  
Available until stock out



Prodotto per scatola rettangolare inglese  
Product for British standard rectangular box



Prodotto per Export  
For Export only



Placche "Ave Touch" in vetro per scatola 4 moduli (interasse 108,5 mm) - PERSONALIZZABILI  
 "Ave Touch" glass front plates for rectangular 4 modules box (fixing centres 108,5 mm) - CUSTOMIZABLE

Descrizione Description	Info	€	<input type="checkbox"/>	<input type="checkbox"/>
<input type="checkbox"/> <b>44PVT4BL/XX</b> Bianco Lucido - 4 moduli <i>Clear White - 4 modules</i>	a commessa upon request		1	1
<input checked="" type="checkbox"/> <b>44PVT4GO/XX</b> Grigio argentato finitura opaca - 4 moduli <i>Frosted silver grey - 4 modules</i>	a commessa upon request		1	1
<input checked="" type="checkbox"/> <b>44PVT4GOLD/XX</b> Oro finitura lucida - 4 moduli <i>Frosted gold - 4 modules</i>	a commessa upon request		1	1
<input checked="" type="checkbox"/> <b>44PVT4NAL/XX</b> Nero assoluto finitura lucida - 4 moduli <i>Clear absolute black - 4 modules</i>	a commessa upon request		1	1
<input checked="" type="checkbox"/> <b>44PVT4VO/XX</b> Verde Acqua finitura opaca - 4 moduli <i>Frosted water green - 4 modules</i>	a commessa upon request		1	1



44PVT4NAL/XX

**Nota:** per ulteriori informazioni vedere pag. 106  
**Note:** for further information see page 106

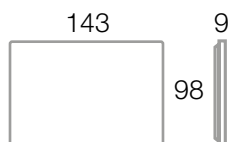

Placche "Ave Touch" in vetro per scatola 6-7 moduli (interasse 158,5 mm) - PERSONALIZZABILI  
 "Ave Touch" glass front plates for rectangular 6-7 modules box (fixing centres 158,5 mm) - CUSTOMIZABLE

Descrizione Description	Info	€	<input type="checkbox"/>	<input type="checkbox"/>
<input type="checkbox"/> <b>44PVT7BL/XX</b> Bianco Lucido - 6-7 moduli <i>Clear White - 6-7 modules</i>	a commessa upon request		1	1
<input checked="" type="checkbox"/> <b>44PVT7GO/XX</b> Grigio argentato finitura opaca - 6-7 moduli <i>Frosted silver grey - 6-7 modules</i>	a commessa upon request		1	1
<input checked="" type="checkbox"/> <b>44PVT7GOLD/XX</b> Oro finitura lucida - 6-7 moduli <i>Frosted gold - 6-7 modules</i>	a commessa upon request		1	1
<input checked="" type="checkbox"/> <b>44PVT7NAL/XX</b> Nero assoluto finitura lucida - 6-7 moduli <i>Clear absolute black - 6-7 modules</i>	a commessa upon request		1	1
<input checked="" type="checkbox"/> <b>44PVT7VO/XX</b> Verde Acqua finitura opaca - 6-7 moduli <i>Frosted water green - 6-7 modules</i>	a commessa upon request		1	1



44PVT7NAL/XX

**Nota:** per ulteriori informazioni vedere pag. 106  
**Note:** for further information see page 106

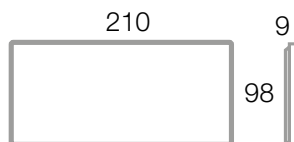



# Placche

## Front Plates



### Placche "Ave Touch" per scatola BL02P - PERSONALIZZABILI

"Ave Touch" front plates for BL02P box - CUSTOMIZABLE

266



44PVT33NAL/XX

Descrizione Description	Info	€	□	□
<b>□ 44PVT33BL/XX</b> Vetro Bianco Lucido - 6(3+3) moduli <i>Clear White glass - 6(3+3) modules</i>	a commessa upon request		1	1
<b>■ 44PVT33GO/XX</b> Vetro Grigio argentato finitura opaca - 6(3+3) moduli <i>Frosted silver grey glass - 6(3+3) modules</i>	a commessa upon request		1	1
<b>■ 44PVT33NAL/XX</b> Vetro Nero assoluto finitura lucida - 6(3+3) moduli <i>Clear absolute black glass - 6(3+3) modules</i>	a commessa upon request		1	1
<b>■ 44PVT33VO/XX</b> Vetro Verde Acqua finitura opaca - 6(3+3) moduli <i>Frosted water green glass - 6(3+3) modules</i>	a commessa upon request		1	1

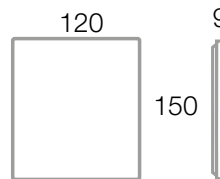

### Placche "Ave Touch" in vetro per Gestione Alberghiera

"Ave Touch" glass front plates for Hotel Management System



44PVT33GA-NAL



44PVT33GA-NAL



44PVT76GA-NAL

Descrizione Description	Info	€	□	□
<b>□ 44PVT33GA-BL</b> Bianco Lucido - 3 moduli <i>Clear White - 3 modules</i>	a commessa upon request		1	1
<b>■ 44PVT33GA-NAL</b> Nero assoluto finitura lucida - 3 moduli <i>Clear absolute black - 3 modules</i>	a commessa upon request		1	1
<b>□ 44PVT33GA-BL</b> Vetro Bianco Lucido - con pulsante chiamata per controllo accessi 442GA02-M 6(3+3) moduli <i>Clear White glass - 6(3+3) modules</i>	a commessa upon request		1	1
<b>■ 44PVT33GA-NAL</b> Vetro Nero assoluto finitura lucida con pulsante chiamata per controllo accessi 442GA02-M 6(3+3) moduli <i>Clear absolute black glass - 6(3+3) modules</i>	a commessa upon request		1	1
<b>□ 44PVT76GA-BL</b> Vetro Bianco Lucido per controllo accessi 442GA02-M 6(3+3) moduli <i>Clear White glass - 6(3+3) modules</i>	a commessa upon request		1	1
<b>■ 44PVT76GA-NAL</b> Vetro Nero assoluto finitura lucida - con pulsante chiamata - per controllo accessi 442GA02-M 6(3+3) moduli <i>Clear absolute black glass - 6(3+3) modules</i>	a commessa upon request		1	1



Per la disponibilità contattare la rete commerciale  
For availability please contact sales dept.



Disponibilità fino ad esaurimento scorte  
Available until stock out



Prodotto per scatola rettangolare inglese  
Product for British standard rectangular box



Prodotto per Export  
For Export only

Placche "Ave Touch" in alluminio per Gestione Alberghiera  
 "Ave Touch" aluminium front plates for Hotel Management System



44PATC3GA-ALS



44PATC33GA-ALS



44PATC76GA-ALS

Descrizione Description	Info	€	<input type="checkbox"/>	<input type="checkbox"/>
<b>44PATC3GA-ALS</b> Alluminio naturale spazzolato - per controllo accessi 442GA02-M - 3 moduli <i>Natural brushed aluminium - for access control 442GA02-M - 3 modules</i>	a commessa upon request		1	1
<b>44PATC3GA-ANS</b> Alluminio antracite spazzolato - per controllo accessi 442GA02-M - 3 moduli <i>Anthracite brushed aluminium- for access control 442GA02-M - 3 modules</i>	a commessa upon request		1	1
<b>44PATC33GA-ALS</b> Alluminio naturale spazzolato - con pulsante chiamata - per controllo accessi 442GA02-M 6(3+3) moduli <i>Natural brushed aluminium - with call push-button - for access control 442GA02M - 6 (3+3) modules</i>	a commessa upon request		1	1
<b>44PATC33GA-ANS</b> Alluminio antracite spazzolato - con pulsante chiamata per controllo accessi 442GA02-M 6(3+3) moduli <i>Anthracite brushed aluminium - with call push-button - for access control 442GA02M - 6 (3+3) modules</i>	a commessa upon request		1	1
<b>44PATC76GA-ALS</b> Alluminio naturale spazzolato - per controllo accessi 442GA02-M - 6(3+3) moduli <i>Natural brushed aluminium - for access control 442GA02-M - 6(3+3) modules</i>	a commessa upon request		1	1
<b>44PATC76GA-ANS</b> Alluminio antracite spazzolato - per controllo accessi 442GA02-M - 6(3+3) moduli <i>Anthracite brushed aluminium- for access control 442GA02-M - 6(3+3) modules</i>	a commessa upon request		1	1

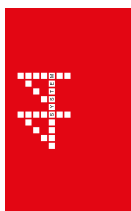

Sistema 45





# Placche multimodulo personalizzabili

## Customizable multi-module front plates

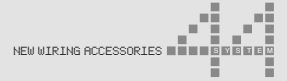

BREVETTO AVE N° 205-209-212-227  
AVE PATENT N° 205-209-212-227

### Prezzi personalizzazione per singola placca

Customization prices for each front plate

**Lotto minimo ordinabile 20 pezzi**

**Costi**

Il costo per ciascuna placca è quello riportato nel presente catalogo a cui deve essere aggiunto un costo una **tantum** pari a **450 € netti**.  
Da distribuire sul numero di pezzi oggetto dell'ordine, per singola personalizzazione.

Per verificarne la fattibilità e i costi contattare la rete commerciale Ave.

**Minimum order quantity 20 pcs**

**Costs**

The cost for each front plate is the one indicated in the official International Price List in force with the **addition** of the first prototype fee of **€ 450**  
To be distributed over the number of pieces subject to the order, for each customization

Please check costs and feasibility with Ave export sales department.

Caratteristiche Tecniche Technical Features

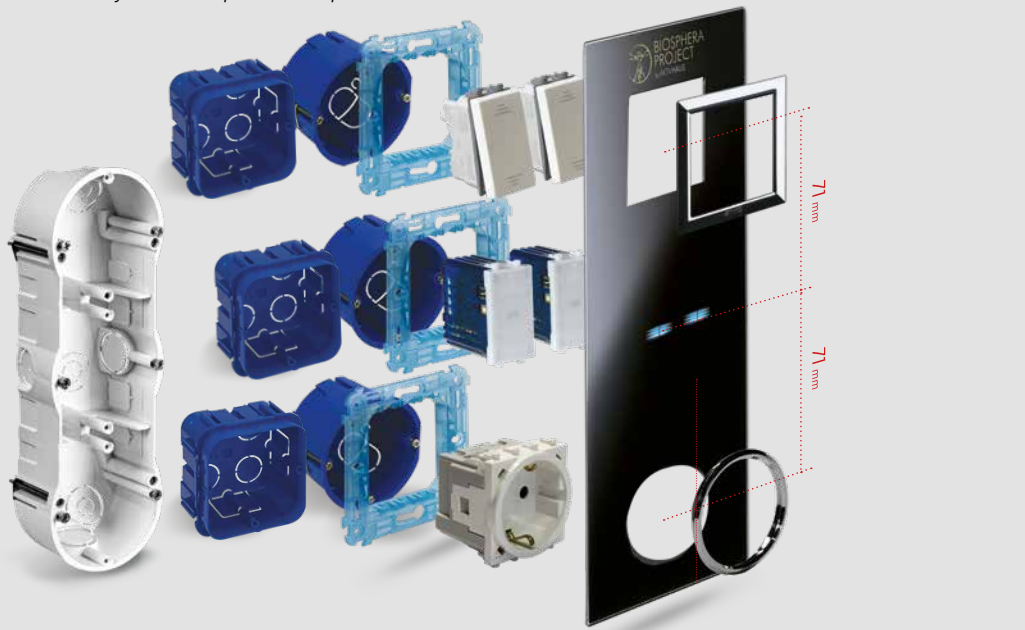

Per la disponibilità contattare la rete commerciale  
For availability please contact sales dept.



Disponibilità fino ad esaurimento scorte  
Available until stock out



Prodotto per scatola rettangolare inglese  
Product for British standard rectangular box

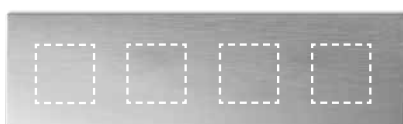
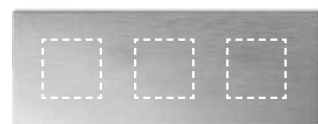
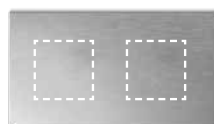

Prodotto per Export  
For Export only

**Descrizione** *Description*
**Info**

€

**Vetro** *Glass*

44PV24BL-XX	Bianco finitura lucida <i>Clear white</i>	a commessa upon request	1	1
44PV24GO-XX	Grigio argentato finitura opaca <i>Frosted silver grey</i>	a commessa upon request	1	1
44PV24GOLD-XX	Oro finitura lucida <i>Clear gold</i>	a commessa upon request	1	1
44PV24NAL-XX	Nero assoluto finitura lucida <i>Clear absolute black</i>	a commessa upon request	1	1
44PV24VO-XX	Verde acqua finitura opaca <i>Frosted water green</i>	a commessa upon request	1	1
44PV26BL-XX	Bianco finitura lucida <i>Clear white</i>	a commessa upon request	1	1
44PV26GO-XX	Grigio argentato finitura opaca <i>Frosted silver grey</i>	a commessa upon request	1	1
44PV26GOLD-XX	Oro finitura lucida <i>Clear gold</i>	a commessa upon request	1	1
44PV26NAL-XX	Nero assoluto finitura lucida <i>Clear absolute black</i>	a commessa upon request	1	1
44PV26VO-XX	Verde acqua finitura opaca <i>Frosted water green</i>	a commessa upon request	1	1
44PV28BL-XX	Bianco finitura lucida <i>Clear white</i>	a commessa upon request	1	1
44PV28GO-XX	Grigio argentato finitura opaca <i>Frosted silver grey</i>	a commessa upon request	1	1
44PV28GOLD-XX	Oro finitura lucida <i>Clear gold</i>	a commessa upon request	1	1
44PV28NAL-XX	Nero assoluto finitura lucida <i>Clear absolute black</i>	a commessa upon request	1	1
44PV28VO-XX	Verde acqua finitura opaca <i>Frosted water green</i>	a commessa upon request	1	1

**Alluminio** *Aluminium*

44PA24ALS-XX	Alluminio naturale spazzolato <i>Natural brushed aluminium</i>	a commessa upon request	1	1
44PA24ANS-XX	Alluminio antracite spazzolato <i>Anthracite brushed aluminium</i>	a commessa upon request	1	1
44PA24GOLD-XX	Alluminio oro spazzolato <i>Gold brushed aluminium</i>	a commessa upon request	1	1
44PA26ALS-XX	Alluminio naturale spazzolato <i>Natural brushed aluminium</i>	a commessa upon request	1	1
44PA26ANS-XX	Alluminio antracite spazzolato <i>Anthracite brushed aluminium</i>	a commessa upon request	1	1
44PA26GOLD-XX	Alluminio oro spazzolato <i>Gold brushed aluminium</i>	a commessa upon request	1	1
44PA28ALS-XX	Alluminio naturale spazzolato <i>Natural brushed aluminium</i>	a commessa upon request	1	1
44PA28ANS-XX	Alluminio antracite spazzolato <i>Anthracite brushed aluminium</i>	a commessa upon request	1	1
44PA28GOLD-XX	Alluminio oro spazzolato <i>Gold brushed aluminium</i>	a commessa upon request	1	1

**Corian®**

44PCT24B-XX	Bianco <i>White</i>	a commessa upon request	1	1
44PCT26B-XX	Bianco <i>White</i>	a commessa upon request	1	1
44PCT28B-XX	Bianco <i>White</i>	a commessa upon request	1	1

 Le dimensioni, salvo diversamente specificato, sono in mm  
 Dimensions, except where otherwise specified, are in mm

 Imballo Minimo pcs  
 Min. Packaging pcs

 Imballo Standard pcs  
 Std. Packaging pcs



# Personalizzazione tasti

## Customizable rockers

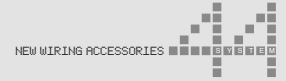

270

### PERSONALIZZAZIONE TASTI SISTEMA 44 SYSTEM 44 ROCKERS CUSTOMIZATION

I simboli di personalizzazione, sono quelli riportati nella tabella "simbologie disponibili". I prezzi sono quelli indicati nella "tabella prezzi" e sono da dividere in base alle quantità, esempio 20 tasti Serie Domus 1 modulo con simbologia diverse il prezzo è da distribuire sui 20 pezzi. Tale operazione è da ripetere in caso di cambio della Serie o cambio di modulo.

The customization symbols are mentioned in the "available symbols" table. The prices are indicated in the "price table" and are to be divided according to the quantities, for example: 20 rockers Domus Series 1 module with different symbols the price is to be distributed over the 20 pieces. This operation is to be repeated in case of change of series or module

Caratteristiche Tecniche Technical Features



Life



Allumia

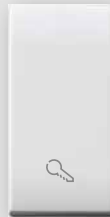

Domus



Tekla



Class

#### Simbologie disponibili

Available symbols

1	2	3	4	5	6	7	8	9	10	11	12
13	14	15	16	17	18	19	20	21	22	23	24
25 <b>FM</b>	26	27	28	29 <b>OFF</b>	30 <b>ON</b>	31 <b>ALARM</b>	32 <b>DO NOT DISTURB</b>	33 <b>RESET</b>	34 <b>APRE</b>	35 <b>CHIUDE</b>	36 <b>AVANTI</b>
37 <b>ESTERNO</b>	38 <b>GARAGE</b>	39 <b>CANTINA</b>	40 <b>GIARDINO</b>	41 <b>GENERALE</b>	42 <b>LUCE</b>	43 <b>RIPOSTIGLIO</b>	44 <b>SCALE</b>	45 <b>SOLAIO</b>	46 <b>TERRAZZA</b>	47 <b>INDIETRO</b>	48 <b>BAGNO</b>

#### Tabella prezzi

Simbologia da libreria, da distribuire sul numero di pezzi:

Price tables  
Library symbols, to be distributed over the number of pieces:

Quantità Quantity	Prezzi Price
<b>Fino a 20 pezzi</b> Until 20 pcs	<b>Netto 15€</b> Unit 15€
<b>Da 21 pz. a 50 pezzi</b> From 21 pcs to 50 pcs	<b>Netto 10€</b> Unit 10€
<b>Da 51 pz. a 100 pezzi</b> From 51 pcs to 100 pcs	<b>Netto 6€</b> Unit 6€

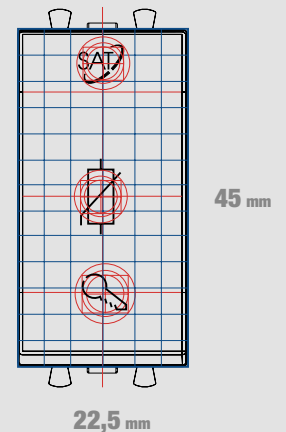

Per la disponibilità contattare la rete commerciale  
For availability please contact sales dept.



Disponibilità fino ad esaurimento scorte  
Available until stock out



Prodotto per scatola rettangolare inglese  
Product for British standard rectangular box



Prodotto per Export  
For Export only



Descrizione *Description*

Info €

271

**VALIGETTA2020** Valigetta campionario Sistema 44 completa  
serie Domus, Life, Allumia, Class, Tekla e New Style

1 1

*Sample case System 44 - Domus, Life, Allumia, Class, Tekla and New Style series*



**VALIGETTA2020**

Le dimensioni, salvo diversamente specificato, sono in mm  
Dimensions, except where otherwise specified, are in mm

Imballo Minimo pcs  
Min. Packaging pcs

Imballo Standard pcs  
Std. Packaging pcs



**Design:**  
B. Dall'Eco  
L. Merletti



# Serie Civili Sistema 44

System 44  
Wiring Accessories

SERIE CIVILI  
WIRING ACCESSORIES



273

Sistema 44  
44 System

Supporti  
Frames

**274**

Contenitori  
Enclosures

**280**



# Supporti e Contenitori

Frames and Enclosures

Supporti per scatole tonde, quadrate e rettangolari  
Frames for round, square and rectangular boxes



BREVETTO AVE n° 208 MODELLO COMUNITARIO  
AVE PATENT N° 208 EU MODEL

274

Componibilità (in mm) Modularity (mm)

Sistema d'aggancio Coupling System

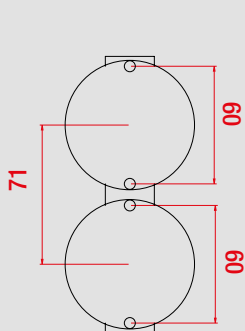

2 Supporti 44A02  
2 44A02 frames

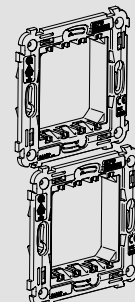
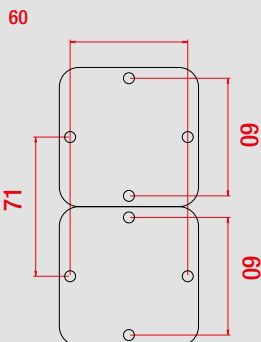
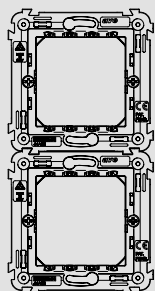

2 Supporti 44A02  
2 44A02 frames

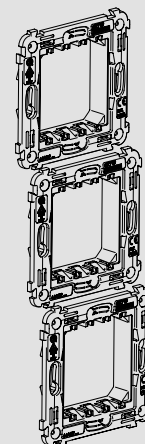

3 Supporti 44A02  
3 44A02 frames

Dime di Foratura (in mm) Cutout Template (mm)

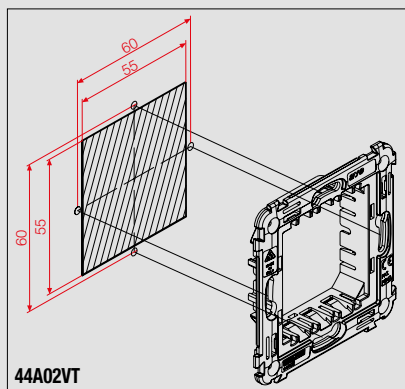

44A02VT

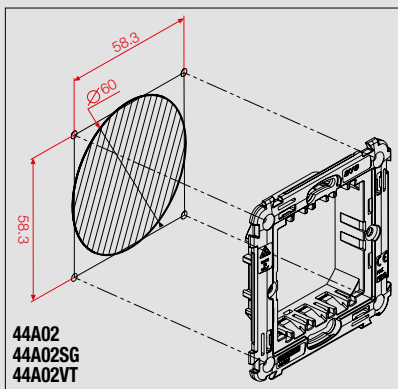

44A02  
44A02SG  
44A02VT

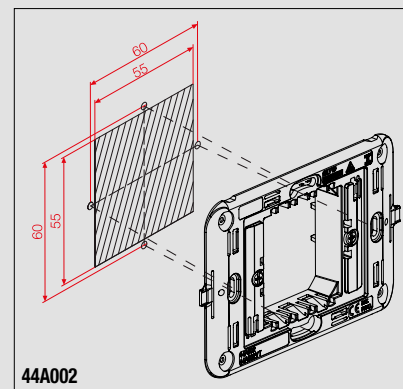

44A002

Caratteristiche Tecniche Technical Features

## Supporti bivalenti Bivalent frames

2 moduli 2 modules



44A/45B2

## Frutti Sistema 44 System 44 devices



Igrostat  
Hygrostat

## Placche Sistema 45 System 45 front plates



Placche "Yes 45"  
"Yes 45" front plates



Placche "Banquise"  
"Banquise" front plates



Placche "Ral 45"  
"Ral 45" front plates

## Soluzione finale Final solution



3 moduli 3 modules



44A/45B



44A/45BP



Spie di segnalazione  
Signaling lamps

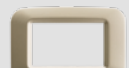

Placche "Yes 45"  
"Yes 45" front plates

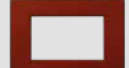

Placche "Spring"  
"Spring" front plates

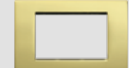



Placche "Zama 45"  
"Zama 45" front plates



Placche "Banquise"  
"Banquise" front plates





## Supporti per scatole tonde e quadrate Frames for round and square boxes

	Cod. Code	Descrizione Description	Info	€	<input type="checkbox"/>	<input type="checkbox"/>
	44A02	Supporto 1-2 moduli per scatola tonda Ø 60 mm - con griffe laterali - componibile con interasse 71 mm <i>1-2 modules frame for round box Ø 60 mm - couplable with centre distance 71 mm - with lateral clips</i>			50	50
44A02 44A02VT	44A02SG	Supporto 1-2 moduli per scatola tonda - senza griffe e senza viti - componibile con interasse 71 mm - installabile su scatole con interasse 60 mm o 56x56 mm <i>1-2 modules frame for round box - without clips and without screws - couplable with centre distance 71 mm - can be installed on boxes with centre distance of 60 mm or 56x56 mm</i>			30	30
	44A02VT	Supporto 1-2 moduli per scatola quadrata o tonda - con viti agganciate in modo imperdibile al supporto - installabile su scatole con interasse 60 mm o 56x56 mm <i>1-2 modules frame for round or square box - with screws hooked to the frame - can be installed on boxes with centre distance of 60 mm or 56x56 mm</i>			30	30
44A02SG	44A002	Supporto 1-2 moduli per scatola tonda Ø 60 mm - con griffe - per placche rettangolari 1 o 2 moduli centrali <i>1-2 modules frame for round box Ø 60 mm - with clips - for rectangular front plates with 1 or 2 central modules</i>			10	10
	44A002					

275

Sistema 45

## Supporti per scatole rettangolari Frames for rectangular boxes

	Cod. Code	Descrizione Description	Info	€	<input type="checkbox"/>	<input type="checkbox"/>
	44A03	Supporto 3 moduli per scatole 2503MG, 253CG - con viti <i>3 modules frame for 2503MG, 253CG boxes - with screws</i>			120	120
44A03	44A002VT	Supporto 1-2 moduli centrali per scatole 2503MG, 253CG e per scatole tonde o quadrate con interasse 60 mm o 56x56 mm - con viti - per placche rettangolari 1 o 2 moduli centrali <i>1-2 central modules frame for 2503MG, 253CG boxes and round or square boxes with centre distance of 60 mm or 56x56 mm - with screws - for rectangular front plates 1 or 2 central modules</i>			10	10
	44A/45B	Supporto 3 moduli per placche S45 - colore bianco RAL 9010 - per scatole 2503MG, 253CG - con viti <i>3 modules frame for S45 front plates - RAL 9010 white colour - for 2503MG, 253CG boxes - with screws</i>			10	10
44A002VT	44A/45BP	Supporto 3 moduli per placche S45 - colore avorio RAL 1013 - per scatole 2503MG, 253CG - con viti <i>3 modules frame for S45 front plates - RAL 1013 ivory colour - for 2503MG, 253CG boxes - with screws</i>			10	10
	44A/45B2	Supporto 1-2 moduli per placche rettangolari S45 1 o 2 moduli centrali - colore bianco RAL 9010 - per scatole 2503MG, 253CG e per scatole tonde o quadrate con interasse 60 mm o 56x56 mm - con viti <i>1-2 modules frame for S45 rectangular front plates with 1 or 2 central modules - colour RAL 9010 white - for 2503MG, 253CG boxes and round or square boxes with centre distance of 60 mm or 56x56 mm - with screws</i>			10	10

### Dime di Foratura (in mm) Cutout Template (mm)

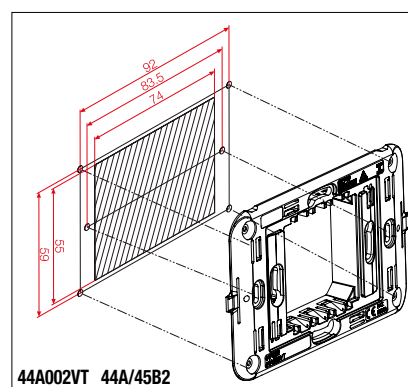
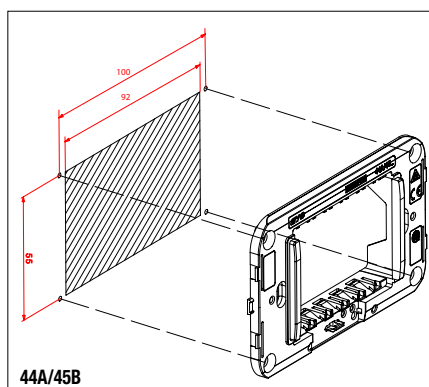
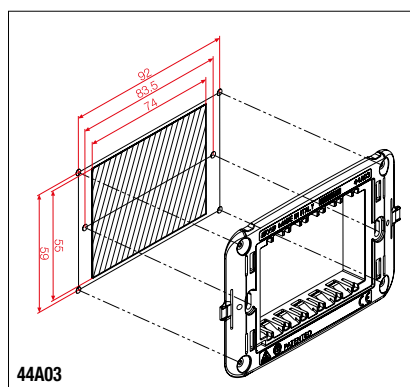

Le dimensioni, salvo diversamente specificato, sono in mm  
Dimensions, except where otherwise specified, are in mm

Imballo Minimo pcs  
Min. Packaging pcs

Imballo Standard pcs  
Std. Packaging pcs



# Supporti e Contenitori

Frames and Enclosures

Supporti per scatole rettangolari

Frames for rectangular boxes



BREVETTO AVE N° 208 MODELLO COMUNITARIO  
AVE PATENT N° 208 EU MODEL

276

Dime di Foratura (in mm) Cutout Template (mm)

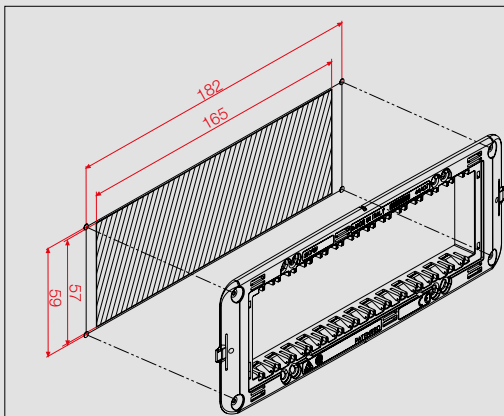

44A07

Nuova versione del supporto a 7 moduli, con l'introduzione del rinforzo metallico  
New version of 7 modules frame with metal support

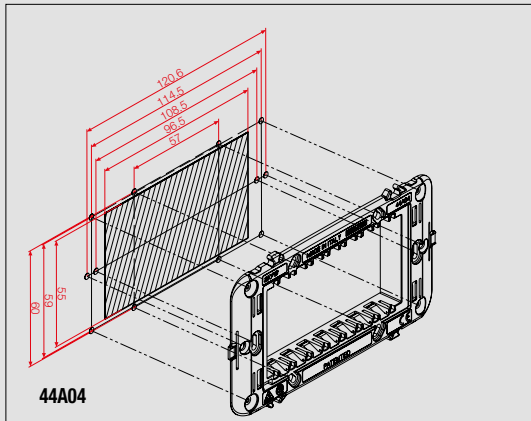
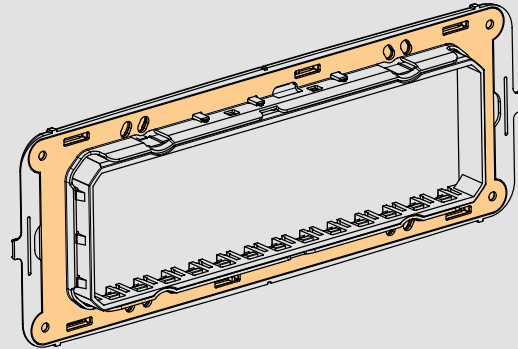

44A04

Altre sedi per aggancio ferretti (opzionali)  
Other seats for supports clipping system (optional)

DM2476  
Ferretti di contenimento spostabili (opzionali)  
Movable metal supports (optional)

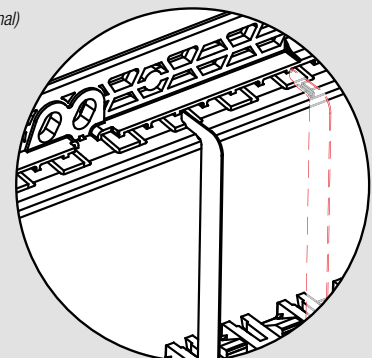

Dime di Foratura (in mm) Cutout Template (mm)

Dime di Foratura (in mm) Cutout Template (mm)

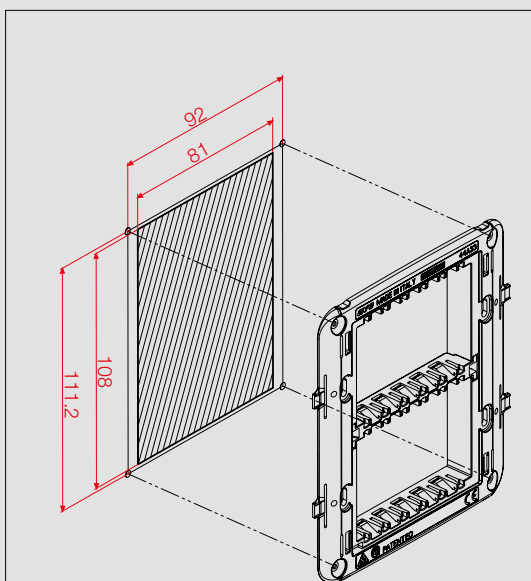

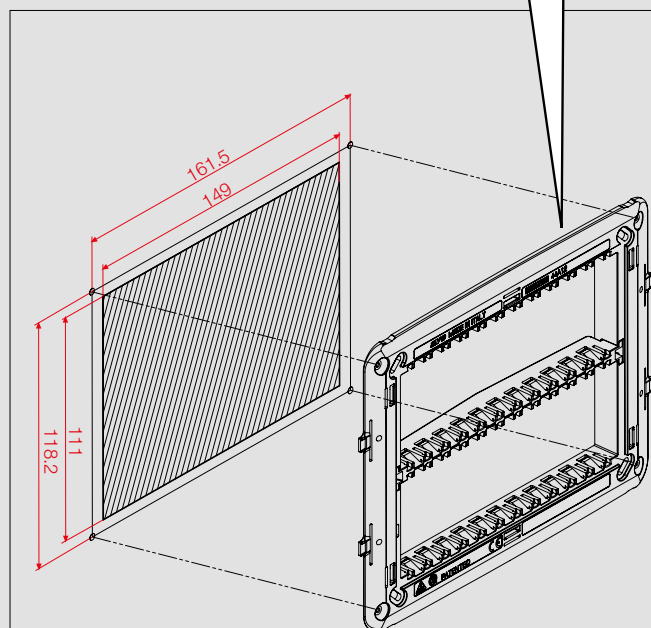

44A33



44A12

Caratteristiche Tecniche Technical Features

## Supporti per scatole rettangolari Frames for rectangular boxes

	Cod. Code	Descrizione Description	Info	€	<input type="checkbox"/>	<input type="checkbox"/>
	44A04	Supporto 4 moduli per scatola 2504 e 254CG - con viti <i>4 modules frame for 2504 and 254CG boxes - with screws</i>			15	15
	44A07	Supporto 7 moduli per scatola 2506 e 256CG - con viti <i>7 modules frame for 2506 and 256CG boxes - with screws</i>			8	8

44A04



44A07

277

Sistema 45

## Supporto per scatola BL02P e BL02CG Frame for BL02P and BL02CG box

	Cod. Code	Descrizione Description	Info	€	<input type="checkbox"/>	<input type="checkbox"/>
	44A33	Supporto 6(3+3) moduli per scatola BL02P - setto amovibile - con viti <i>6(3+3) modules frame for BL02P box - removable separator - with screws</i>			8	8

44A33

## Supporto per scatola BL05P e BL05CG Frame for BL05P and BL05CG box

	Cod. Code	Descrizione Description	Info	€	<input type="checkbox"/>	<input type="checkbox"/>
	44A12	Supporto 12(6+6) moduli per scatola BL05P e BL05CG - setto amovibile - con viti <i>12(6+6) modules frame for BL05P and BL05CG box - removable separator - with screws</i>			1	1

44A12

Le dimensioni, salvo diversamente specificato, sono in mm  
Dimensions, except where otherwise specified, are in mm

Imballo Minimo pcs  
Min. Packaging pcs

Imballo Standard pcs  
Std. Packaging pcs

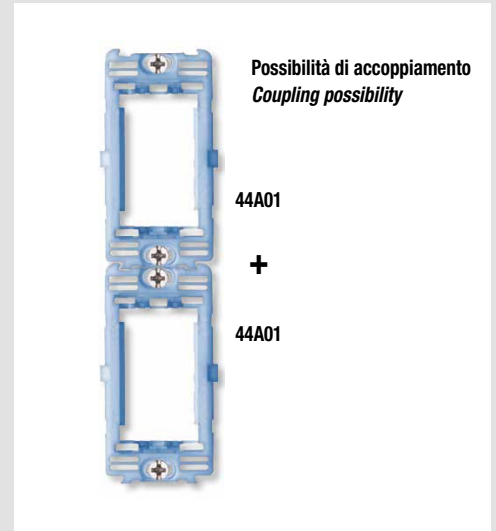
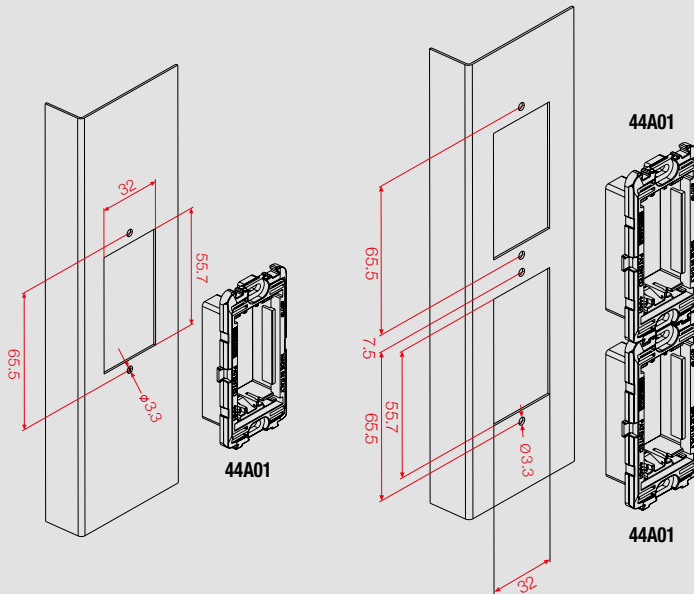

Caratteristiche Tecniche Technical Features

Dimensioni d'ingombro (in mm) Dimensions (mm)

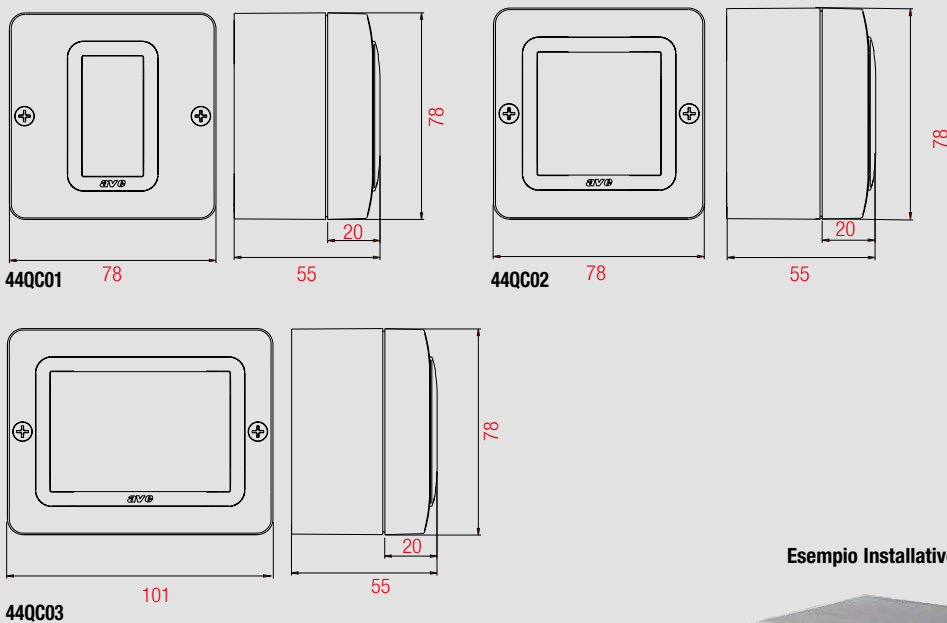

Vista posteriore Rear View

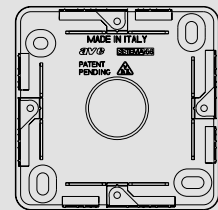

Esempio Installativo Installation example

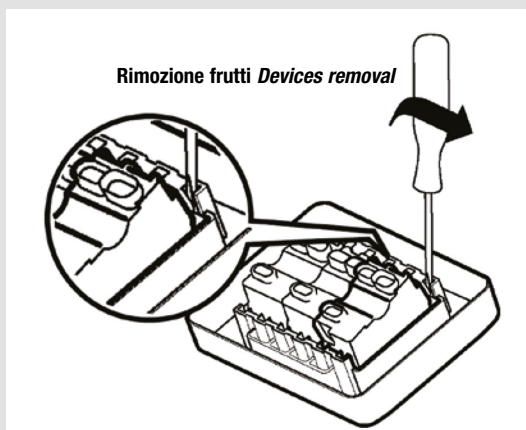



## Supporto per pannelli/profilati Frame for section bars

Cod. Code	Descrizione Description	Info	€	□	□
44A01	Supporto 1 modulo per pannelli/profilati componibile in verticale - con viti <i>1 module frame for section bars couplable in vertical - with screws</i>			10	10



44A01

279

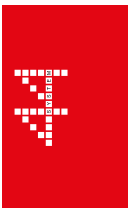

Sistema 45

## Accessori Accessories

Cod. Code	Descrizione Description	Info	€	□	□
442PP	Coperchio di protezione trasparente per imbiancatura - applicabile al supporto 44A03 <i>Transparent protection cover for painting - suitable for frame 44A03</i>			50	50
VL0922	Vite lunga 35 mm per fissaggio supporti su scatole incassate sotto il filo intonaco <i>Long screw 35 mm to fix frames onto boxes installed below plaster level</i>			10	100
VL0923	Vite lunga 48 mm per fissaggio supporti su scatole incassate sotto il filo intonaco <i>Long screw 48 mm to fix frames onto boxes installed below plaster level</i>			100	100



442PP



VL0922



VL0923

## Contenitori autoportanti IP40 colore RAL 9010 per minicanali RAL 9010 self-supporting enclosures IP40 for mini trunkings

Cod. Code	Descrizione Description	Info	€	□	□
44QC01	1 modulo S44 - per minicanali da 20x10 mm a 30x18 mm - fissaggio base/coperchio con 2 viti <i>1 module S44 - for mini trunkings from 20x10 mm to 30x18 mm - fixing of base/cover with 2 screws</i>			24	24
44QC02	2 moduli S44 - per minicanali da 20x10 mm a 30x18 mm - fissaggio base/coperchio con 2 viti <i>2 modules S44 - for mini trunkings from 20x10 mm to 30x18 mm - fixing of base/cover with 2 screws</i>			24	24
44QC03	3 moduli S44 - per minicanali da 20x10 mm a 30x18 mm - fissaggio base/coperchio con 2 viti <i>3 modules S44 - for mini trunkings from 20x10 mm to 30x18 mm - fixing of base/cover with 2 screws</i>			20	20



44QC01



44QC02



44QC03

**Nota:** l'aggancio e la rimozione dei frutti avviene dal retro del coperchio  
**Note:** devices coupling and removal from the rear part

Le dimensioni, salvo diversamente specificato, sono in mm  
Dimensions, except where otherwise specified, are in mm

Imballo Minimo pcs  
Min. Packaging pcs

Imballo Standard pcs  
Std. Packaging pcs





# Armature e Contenitori

Frames and Enclosures



Scatole Universali IP40 colore RAL 9010 per minicanali  
IP40 Universal boxes RAL 9010 for mini trunkings

## Esploso Installativo Installation diagram

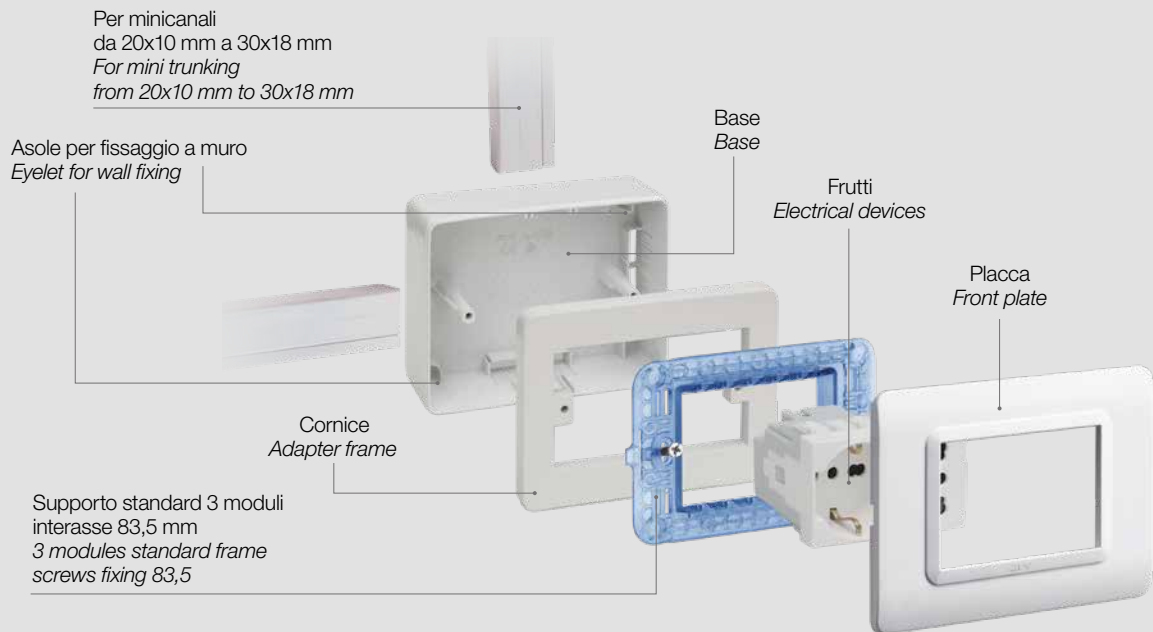

## Dimensioni d'ingombro (in mm) Dimensions (mm)

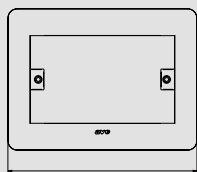

44SC03 123



46.5

## Vista posteriore Rear view

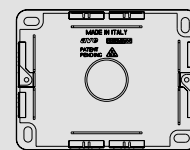

44SC03

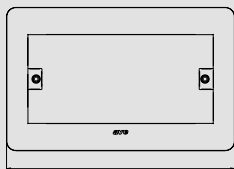

44SC04 146.5



46.5



44SC04

Scatola portafrutto IP40 per placche "Vera 44"  
IP40 boxes RAL9010 for "Vera 44" front plates

Supporti per guida DIN EN 50022  
Supports for DIN EN 50022 rail

## Dimensioni d'ingombro (in mm) Dimensions (mm)

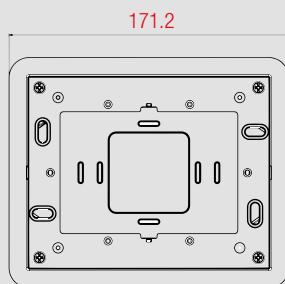

44S33

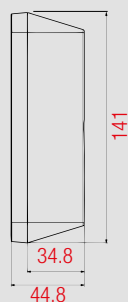

141

34.8

44.8

## Rimozione frutti Devices removal

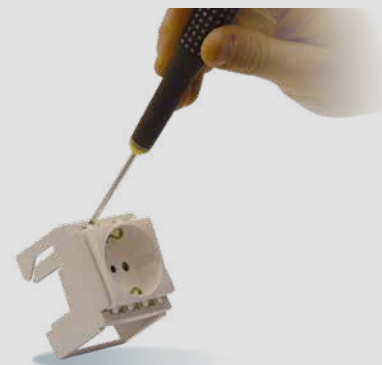

Caratteristiche Tecniche Technical Features



Per la disponibilità contattare la rete commerciale  
For availability please contact sales dept.



Disponibilità fino ad esaurimento scorte  
Available until stock out



Prodotto per scatola rettangolare inglese  
Product for British standard rectangular box



Prodotto per Export  
For Export only

## Scatole Universali IP40 colore RAL 9010 per minicanali

### IP40 Universal boxes RAL 9010 for mini trunkings

Cod. Code	Descrizione Description	Info	€	<input type="checkbox"/>	<input type="checkbox"/>
44SC03	3 moduli - da utilizzare con supporti standard 3 moduli (interasse 83,5 mm) - per minicanali da 20x10 mm a 30x18 mm <i>3 modules - to be used with standard 3 module frames (centre distance 83,5 mm) for trunking from 20x10 mm to 30x18 mm</i>			1	20
44SC04	4 moduli - da utilizzare con supporti standard 4 moduli (interasse 108 mm) - per minicanali da 20x10 mm a 30x18 mm <i>4 modules - to be used with standard 4 module frames (centre distance 108 mm) for trunking from 20x10 mm to 30x18 mm</i>			1	15

44SC03



44SC04

**Nota:** adatte anche per placche Sistema 45  
**Note:** suitable also for System 45 front plates

281

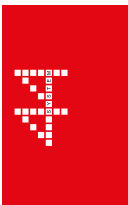

Sistema 45

## Scatola portafrutto IP40 per placche "Vera 44" IP40 boxes RAL 9010 for "Vera 44" front plates

Cod. Code	Descrizione Description	Info	€	<input type="checkbox"/>	<input type="checkbox"/>
44S33	Scatola d'arredo 3+3 moduli con <b>profondità ridotta</b> - da utilizzare con supporto 44A33 - completare con placche "Vera 44" cod. 44PV33..., 44PA33..., 44PL33... - colore RAL9010 <i>Wall mounted 3+3 modules with reduced depth - to be used with 44A33 - to be completed with "Vera 44" plates 44PV33..., 44PA33..., 44PL33... - colour RAL9010</i>			1	1



44S33

## Supporti per guida DIN EN 50022 Supports for DIN EN 50022 rail

Cod. Code	Descrizione Description	Info	€	<input type="checkbox"/>	<input type="checkbox"/>
53/44	Supporto 1 modulo S44 per applicazione a guida DIN EN 50022 - occupa 1,5 moduli DIN da 17,5 mm - colore RAL7035 <i>1 module adapter to install S44 on DIN EN 50022 rail</i> - 1,5 DIN modules of 17,5 mm - colour RAL7035			20	20
53/44/2	Supporto 2 moduli S44 per applicazione a guida DIN EN 50022 - occupa 3 moduli DIN da 17,5 mm - colore RAL7035 <i>3 modules adapter to install S44 on DIN EN 50022 rail</i> - 3 DIN modules of 17,5 mm - colour RAL7035			8	8



53/44



53/44/2

Le dimensioni, salvo diversamente specificato, sono in mm  
Dimensions, except where otherwise specified, are in mm

Imballo Minimo pcs  
Min. Packaging pcs

Imballo Standard pcs  
Std. Packaging pcs



# Supporti e Contenitori

Frames and Enclosures



Contenitori da parete autoportanti IP40 per tubo  
IP40 wall mounted enclosures for duct - self-supporting

Dimensioni d'ingombro (in mm) *Dimensions (mm)*

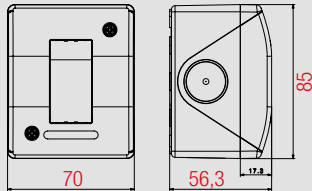

44Q01 - 44Q01B

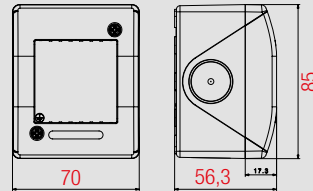

44Q02 - 44Q02B

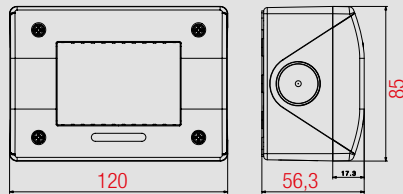

44Q03 - 44Q03B

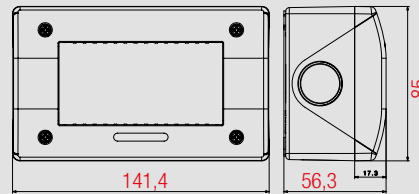

44Q04 - 44Q04B

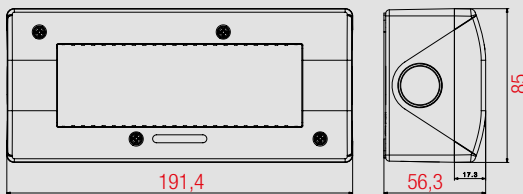

44Q06 - 44Q06B

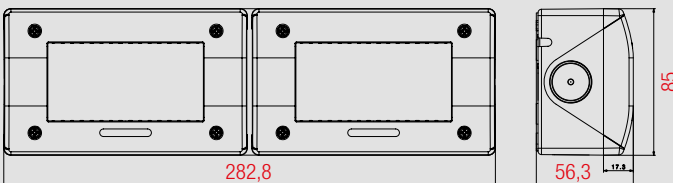

44Q08

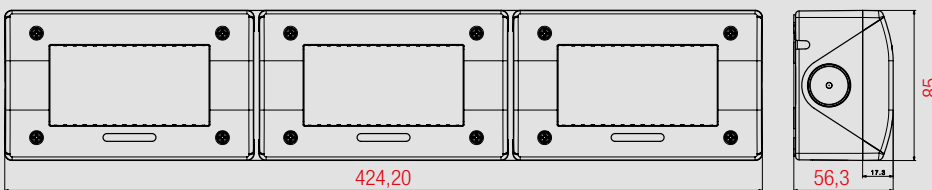

44Q12

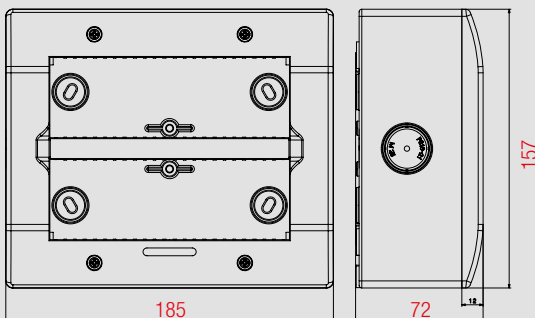

44Q12V - 44Q12VB

Caratteristiche Tecniche *Technical Features*



Per la disponibilità contattare la rete commerciale  
For availability please contact sales dept.



Disponibilità fino ad esaurimento scorte  
Available until stock out







Prodotto per scatola rettangolare inglese  
Product for British standard rectangular box



Prodotto per Export  
For Export only

**Contenitori da parete autoportanti IP40 per tubo**  
*IP40 wall mounted enclosures for duct - self-supporting*

	Cod. Code	Descrizione Description	Info	€	<input type="checkbox"/>	<input type="checkbox"/>
	44Q01	1 modulo S44 - colore RAL 7035 <i>1 module S44 - RAL 7035 colour</i>			24	24
	44Q01B	1 modulo S44 - colore Bianco RAL 9010 <i>1 module S44 - white RAL 9010 colour</i>			24	24
	44Q02	2 moduli S44 - colore RAL 7035 <i>2 modules S44 - RAL 7035 colour</i>			24	24
	44Q02B	2 moduli S44 - colore Bianco RAL 9010 <i>2 modules S44 - white RAL 9010 colour</i>			24	24
	44Q03	3 moduli S44 - colore RAL 7035 <i>3 modules S44 - RAL 7035 colour</i>			20	20
	44Q03B	3 moduli S44 - colore Bianco RAL 9010 <i>3 modules S44 - white RAL 9010 colour</i>			20	20
	44Q04	4 moduli S44 - colore RAL 7035 <i>4 modules S44 - RAL 7035 colour</i>			20	20
	44Q04B	4 moduli S44 - colore Bianco RAL 9010 <i>4 modules S44 - white RAL 9010 colour</i>			20	20
	44Q06	6 moduli S44 - colore RAL 7035 <i>6 modules S44 - RAL 7035 colour</i>			1	10
	44Q06B	6 moduli S44 - colore Bianco RAL 9010 <i>6 modules S44 - white RAL 9010 colour</i>			1	10
	44Q08	8 (4+4) moduli S44 - installazione orizzontale - colore RAL 7035 <i>8 (4+4) modules S44 - horizontal installation - RAL 7035 colour</i>			1	6
	44Q12	12 (4+4+4) moduli S44 - installazione orizzontale - colore RAL 7035 <i>12 (4+4+4) modules S44 - horizontal installation - RAL 7035 colour</i>			1	18
	44Q12V	12 (6+6) moduli S44 - installazione verticale - colore RAL 7035 <i>12 (6+6) modules S44 - vertical installation - RAL 7035 colour</i>			1	6
	44Q04	12 (6+6) moduli S44 - installazione verticale - colore Bianco RAL 9010 <i>12 (6+6) modules S44 - vertical installation - white RAL 9010 colour</i>			1	6

44Q04



44Q06



44Q08



44Q12



44Q12VB



44Q12V



Sistema 45

Le dimensioni, salvo diversamente specificato, sono in mm  
 Dimensions, except where otherwise specified, are in mm

Imballo Minimo pcs  
 Min. Packaging pcs

Imballo Standard pcs  
 Std. Packaging pcs

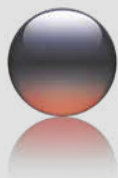

# Supporti e Contenitori

Frames and Enclosures



Placche autoportanti stagne (IP55) - sportello con membrana cedibile  
IP55 splash-proof front plates with soft membrane cover - self-supporting

Caratteristiche Tecniche Technical Features



Sgancio: tenere premuto il fronte del frutto...  
Release: keep pressing the device front part...



... contemporaneamente, inserire il cacciavite, nell'apposito foro e ruotare per estrarre il frutto.  
...at the same time, insert the screwdriver in the dedicated hole and rotate to extract the device



Sistema di bloccaggio dello sportello aperto  
**OPENBLOCK**  
Locking system of the door open

Punti di ancoraggio dello sportello al coperchio rinforzati grazie all'introduzione di un perno metallico  
Fixing points between lid and frame strengthened by metallic hinge

Nervature per bloccaggio sportello in posizione di aperto  
Possibility to block the lid in open position



Angolo apertura sportello oltre 160°  
Opening angle of the lid over 160°

- ✓ Sede per inserimento dita molto ampia per facilitare l'apertura
- ✓ Sede per vite di bloccaggio antiapertura
- ✓ Wide opening for fingers to ease opening
- ✓ Seat for anti-opening block screw

Dimensioni d'ingombro (in mm) Dimensions (mm)

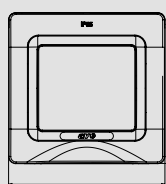

44SP02

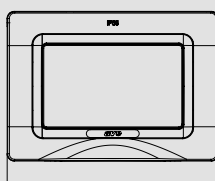

44SP03

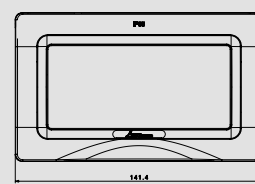

44SP04

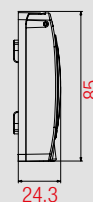

Per la disponibilità contattare la rete commerciale  
For availability please contact sales dept.



Disponibilità fino ad esaurimento scorte  
Available until stock out









Prodotto per scatola rettangolare inglese  
Product for British standard rectangular box



Prodotto per Export  
For Export only

**Placche autoportanti stagne (IP55) - sportello con membrana cedibile**  
*IP55 splash-proof front plates with soft membrane cover - self-supporting*

	Cod. Code	Descrizione Description	Info	€	□	□
	<b>44SP02B</b>	Placca 2 moduli S44 - fissaggio con griffe laterali su scatola tonda Ø 60 mm - colore bianco RAL9010 <i>2 modules front plate S44 - to be fixed by lateral clips on round box Ø 60mm - RAL 9010 white colour</i>			1	40
<b>44SP02B</b>						
	<b>44SP02GSL</b>	Placca 2 moduli S44 - fissaggio con griffe laterali su scatola tonda Ø 60 mm - colore grigio scuro lucido <i>2 modules front plate S44 - to be fixed by lateral clips on round box Ø 60mm - polished dark grey</i>			1	40
<b>44SP02GSL</b>						
	<b>44SP03B</b>	Placca 3 moduli S44 - fissaggio con viti su scatola rettangolare standard 3 moduli - colore bianco RAL9010 <i>3 modules front plate S44 - to be fixed by screws on standard 3 modules rectangular box - RAL 9010 white colour</i>			1	6
<b>44SP03B</b>						
	<b>44SP03GSL</b>	Placca 3 moduli S44 - fissaggio con viti su scatola rettangolare standard 3 moduli - colore grigio scuro lucido <i>3 modules front plate S44 - to be fixed by screws on standard 3 modules rectangular box - polished dark grey</i>			1	6
<b>44SP03GSL</b>						
	<b>44SP04B</b>	Placca 4 moduli S44 - fissaggio con viti su scatola rettangolare standard 4 moduli - colore bianco RAL9010 <i>4 modules front plate S44 - to be fixed by screws on standard 4 modules rectangular box - RAL 9010 white colour</i>			1	1
<b>44SP04B</b>						
	<b>44SP04GSL</b>	Placca 4 moduli S44 - fissaggio con viti su scatola rettangolare standard 4 moduli - colore grigio scuro lucido <i>4 modules front plate S44 - to be fixed by screws on standard 4 modules rectangular box - polished dark grey</i>			1	1
<b>44SP04GSL</b>						

Note: ✓ grado di protezione IP55 garantito in installazioni su pareti impermeabili e piastrelle con irregolarità e scanalature fino a 2 mm di profondità

✓ grado di protezione IP55 garantito con apparecchi di comando o altri apparecchi modulari che consentano la chiusura dello sportello nella condizione ordinaria di servizio

Notes: ✓ IP55 protection degree guaranteed on waterproof walls and tiles with irregularities and grooving up to 2 mm depth  
 ✓ IP55 protection degree guaranteed by control devices or other modular devices which allow the lid closure in ordinary performing conditions

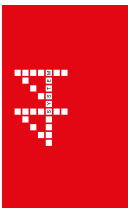





# Supporti e Contenitori

Frames and Enclosures



Contenitori autoportanti stagni (IP55) per tubo- sportello con membrana cedibile  
IP55 wall mounted enclosures with soft membrane cover for duct- self-supporting



- ✓ Sede per inserimento dita molto ampia per facilitare l'apertura
- ✓ Sede per vite di bloccaggio antiapertura
- ✓ Wide opening for fingers to ease opening
- ✓ Seat for anti-opening block screw

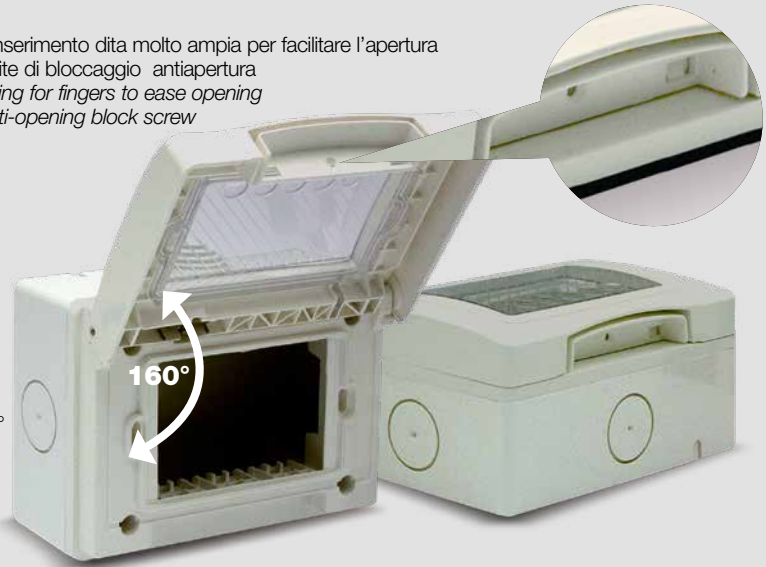

Angolo apertura sportello oltre 160°  
Opening angle of the lid over 160°

Passacavo/passatubo universale inserito nella parete superiore della base  
Universal conduit/cable entry on the upper side of the base

Interassi per fori fissaggio a parete  
Centre distance for wall mounting

Invito per facilitazione sfinestratura a mezzo fresa  
Lightening to ease cutting

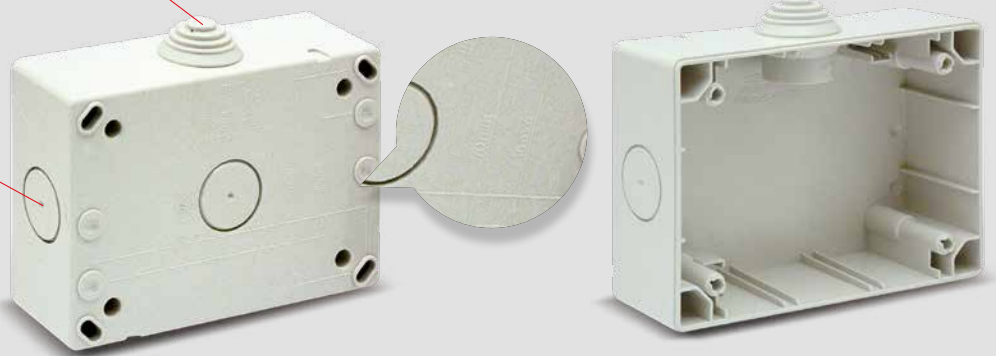

Dimensioni d'ingombro (in mm) Dimensions (mm)

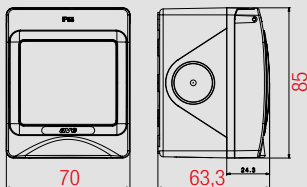

44ST01 - 44ST01B  
44ST02 - 44ST02B

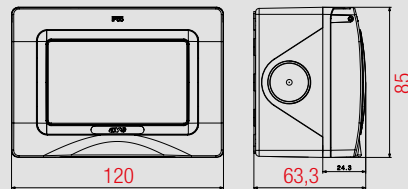

44ST03 - 44ST03B

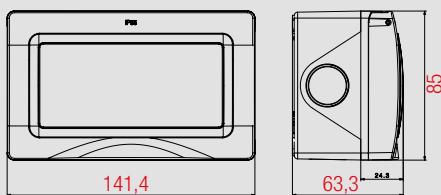

44ST04 - 44ST04B

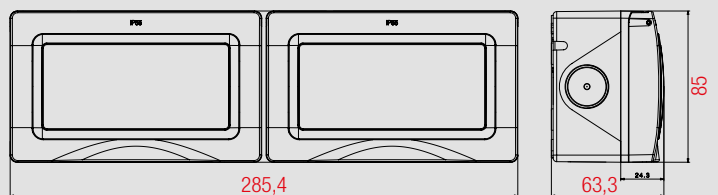

44ST08R



Per la disponibilità contattare la rete commerciale  
For availability please contact sales dept.



Disponibilità fino ad esaurimento scorte  
Available until stock out



Prodotto per scatola rettangolare inglese  
Product for British standard rectangular box



Prodotto per Export  
For Export only



**Contenitori autoportanti stagni (IP55) per tubo- sportello con membrana cedibile**  
*IP55 wall mounted enclosures with soft membrane cover for duct- self-supporting*

	Cod. Code	Descrizione Description	Info	€	□	□
	44ST01	1 modulo S44 - colore RAL 7035 <i>1 module S44 - RAL 7035 colour</i>			24	24
	44ST01B	1 modulo S44 - colore bianco RAL 9010 <i>1 module S44 - white RAL 9010 colour</i>			24	24
	44ST02	2 moduli S44 - colore RAL 7035 <i>2 modules S44 - RAL 7035 colour</i>			24	24
	44ST02B	2 moduli S44 - colore bianco RAL 9010 <i>2 modules S44 - white RAL 9010 colour</i>			24	24
	44ST03	3 moduli S44 - colore RAL 7035 <i>3 modules S44 - RAL 7035 colour</i>			20	20
	44ST03B	3 moduli S44 - colore bianco RAL 9010 <i>3 modules S44 - white RAL 9010 colour</i>			20	20
	44ST04	4 moduli S44 - colore RAL 7035 <i>4 modules S44 - RAL 7035 colour</i>			20	20
	44ST04B	4 moduli S44 - colore bianco RAL 9010 <i>4 modules S44 - white RAL 9010 colour</i>			20	20
	44ST080R	8 (4+4) moduli S44 - colore RAL 7035 <i>8 (4+4) modules S44 - RAL 7035 colour</i>			1	6
	45ST99	Scatola di derivazione da parete - colore RAL 7035 <i>Wall mounted junction box - RAL 7035 colour</i>			1	20

**Nota:** grado di protezione IP55 garantito con apparecchi di comando o altri apparecchi modulari che consentano la chiusura dello sportello nella condizione ordinaria di servizio

**Note:** IP55 protection degree guaranteed by control devices or other modular devices which allow the lid closure in ordinary performing conditions



44ST03



44ST04



44ST080R



45ST99

**Accessori per contenitori IP40 e IP55 Accessories for IP40 and IP55 wall mounted enclosures**

	Cod. Code	Descrizione Description	Info	€	□	□
	44PC00	Passacavo/passatubo universale - da applicare a sfondabili Ø 24 mm <i>Universal conduit entry - to be fixed on breakable holes Ø 24mm</i>			10	10
	45PC00	Passacavo/passatubo universale filettato - da applicare a sfondabili Ø 24 mm <i>Universal threaded conduit entry - to be fixed on breakable holes Ø 24mm</i>			10	10
	45PRT20	Pressatubo per tubi Ø 20mm - da applicare a sfondabili Ø 24mm <i>Tube gland for tubes Ø 20mm - to be fixed on breakable holes Ø 24mm</i>			5	5
	45RD03	Raccordo di giunzione scatole per passaggio cavi - da applicare a sfondabili Ø 24mm <i>Box coupler for cables passage - to be fixed on breakable holes Ø 24mm</i>			10	10



45PRT20

Le dimensioni, salvo diversamente specificato, sono in mm  
 Dimensions, except where otherwise specified, are in mm

 Imballo Minimo pcs  
 Min. Packaging pcs

 Imballo Standard pcs  
 Std. Packaging pcs