

Design:
A. Van Onck
M. Hasuike
H.M.R.
B. Dall'Eco
L. Merletti

Serie Civili

Sistema 45

System 45

Wiring Accessories

SERIE CIVILI
WIRING ACCESSORIES



329

Placche
Banquise 45
VBanquise 45 front plates

330

Placche
Zama 45
Zama 45 front plates

334

Placche
Spring
Spring front plates

339

Placche
Yes 45
YYes 45 front plates

340

Placche
RAL 45
RAL 45 front plates

350

Placche
Blanc 45
Blanc 45 front plates

354



Placche

Front Plates

Sistema 45

Placche in metallo "Banquise" con inserto illuminabile per scatola rettangolare
 "Banquise" metal front plates with lightable insert for rectangular boxes

Design:
M. Hasuike

330

3 MODULI / 3 MODULES

Cod. Code Descrizione Description

Info

€ □ □



45PB93AO



45PB93CR

45PB93AO Argento opaco
Matt silver

45PB93AZM Azzurro pastello micalizzato
Mica-finished pastel sky-blue

45PB93BMC Bianco Banquise micalizzato
Mica-finished Banquise white

45PB93CR Cromo
Chrome

45PB93GSM Grigio scuro metallizzato
Metallic dark grey

45PB93NC Nichel
Nickel

45PB93NCS Nichel spazzolato
Brushed nickel

45PB93OT Ottone lucido
Polished brass

1 15

1 15

1 15

1 15

1 15

1 15

1 15

1 15



45PB93BMC



45PB93NC



45PB93NCS



45PB93AZM



45PB93GSM



45PB93OT

Fori per installazione a pannello
Fixing holes for panel mounting

Foro di autocentraggio placche
Centering hole

Inserto illuminabile
B0220 o B0220HI
B0220 or B0220HI insert

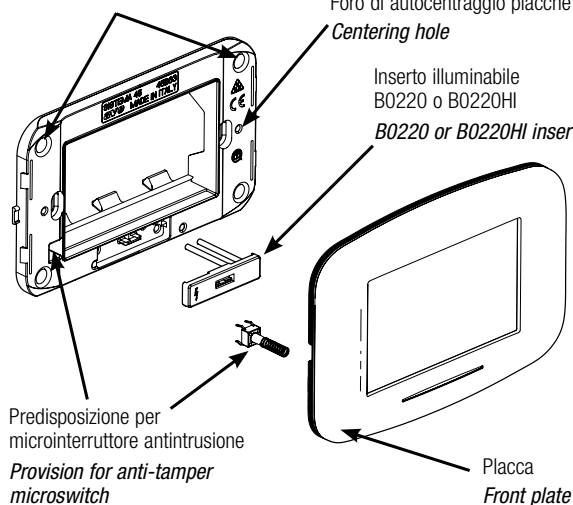

Predisposizione per microinterruttore antintrusione
Provision for anti-tamper microswitch

Placca
Front plate

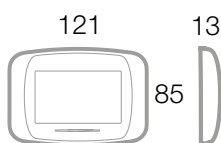

Armatura da utilizzare
To be used with



45B63



Per la disponibilità contattare la rete commerciale
For availability please contact sales dept.



Disponibilità fino ad esaurimento scorte
Available until stock out



Prodotto 2 moduli adatto anche per scatola tonda
2 modules product suitable for round box



Prodotto per scatola rettangolare inglese
Product for British standard rectangular box



Prodotto per Export
For Export only

Placche in metallo "Banquise" con inserto illuminabile per scatola rettangolare
 "Banquise" metal front plates with lightable insert for rectangular boxes

Design:
M. Hasuike

4 MODULI / 4 MODULES	Cod. Code	Descrizione Description	Info	€	<input type="checkbox"/>	<input type="checkbox"/>
 	45PB94AO	Argento opaco <i>Matt silver</i>		1	14	
	45PB94AZM	Azzurro pastello micalizzato <i>Mica-finished pastel sky-blue</i>		1	14	
	45PB94BMC	Bianco Banquise micalizzato <i>Mica-finished Banquise white</i>		1	14	
	45PB94GSM	Grigio scuro metallizzato <i>Metallic dark grey</i>		1	14	
	45PB94NC	Nichel <i>Nickel</i>		1	14	
	45PB94NCS	Nichel spazzolato <i>Brushed nickel</i>		1	14	
	45PB94OT	Ottone lucido <i>Polished brass</i>		1	14	

Armatura da utilizzare
To be used with



45764

Placche in metallo "Banquise" con inserto illuminabile per scatola rettangolare
 "Banquise" metal front plates with lightable insert for rectangular boxes

6 MODULI / 6 MODULES	Cod. Code	Descrizione Description	Info	€	<input type="checkbox"/>	<input type="checkbox"/>
 	45PB96AO	Argento opaco <i>Matt silver</i>		1	10	
	45PB96AZM	Azzurro pastello micalizzato <i>Mica-finished pastel sky-blue</i>		1	10	
	45PB96BMC	Bianco Banquise micalizzato <i>Mica-finished Banquise white</i>		1	10	
	45PB96CR	Cromo <i>Chrome</i>		1	10	
	45PB96GF	Grafite <i>Graphite</i>		1	10	
	45PB96GSM	Grigio scuro metallizzato <i>Metallic dark grey</i>		1	10	
	45PB96NC	Nichel <i>Nickel</i>		1	10	
	45PB96NCS	Nichel spazzolato <i>Brushed nickel</i>		1	10	

Armatura da utilizzare
To be used with



45366

Le dimensioni, salvo diversamente specificato, sono in mm
 Dimensions, except where otherwise specified, are in mm

Prodotto per scatola quadrata
Product for British Standard square box only

2 Prodotto 1 modulo installabile in scatola tonda con altro prodotto 1 modulo
1 module product installable in round box with another 1 module device

Imballo Minimo pcs
Min. Packaging pcs

Imballo Standard pcs
Std. Packaging pcs



Placche

Front Plates

Sistema 45

Placche in metallo "Banquise" con inserto illuminabile per scatola BL02P
 "Banquise" metal front plates with lightable insert for BL02P boxes

Design:
M. Hasuike

332

6(3+3) MODULI / 6(3+3) MODULES

Cod. Code Descrizione Description

Info

€ □ □



45PB933BB Bianco Banquise (RAL 9016)
Banquise white (RAL 9016)

1 1

45PB933GSM Grigio scuro metallizzato
Metallic dark grey

1 1

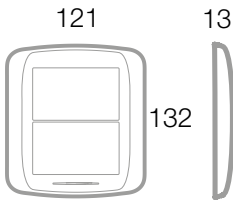

Armatura da utilizzare
To be used with



45B66

Inserti illuminabili Lightable Inserts

Cod. Code Descrizione Description

Info

€ □ □



B0220 Inserto illuminabile per placche Banquise in metallo - 230Vca
Lightable insert for Banquise front plates

10 10

B0220HI Inserto illuminabile ad alta intensità luminosa per placche Banquise in metallo - 230Vca
High intensity LED insert for Banquise front plates - 230Vac

10 10



Per la disponibilità contattare la rete commerciale
For availability please contact sales dept.



Disponibilità fino ad esaurimento scorte
Available until stock out



Prodotto 2 moduli adatto anche per scatola tonda
2 modules product suitable for round box



Prodotto per scatola rettangolare inglese
Product for British standard rectangular box



Prodotto per Export
For Export only

Placche in tecnopolimero "Banquise" per scatola rettangolare "Banquise" moulded front plates for rectangular boxes

Design:
M. Hasuike

3 MODULI / 3 MODULES		Cod. Code	Descrizione Description	Info	€	<input type="checkbox"/>	<input type="checkbox"/>
 45PB03BB	45PB03BB	Bianco Banquise (RAL 9016) <i>Banquise white (RAL 9016)</i>	1	25			
	45PB03BP	Bianco Blanc (RAL 1013) <i>Blanc white (RAL 1013)</i>	1	25			
	45PB03GSM	Grigio scuro metallizzato <i>Metallic dark grey</i>	1	25			
	45PB03NL	Nero lucido <i>Polished black</i>	1	25			

Armatura da utilizzare
To be used with



45B63

Placche in tecnopolimero "Banquise" per scatola rettangolare "Banquise" moulded front plates for rectangular boxes

4 MODULI / 4 MODULES		Cod. Code	Descrizione Description	Info	€	<input type="checkbox"/>	<input type="checkbox"/>
 	45PB04BB	Bianco Banquise (RAL 9016) <i>Banquise white (RAL 9016)</i>	1	20			
	45PB04BP	Bianco Blanc (RAL 1013) <i>Blanc white (RAL 1013)</i>	1	20			
	45PB04GSM	Grigio scuro metallizzato <i>Metallic dark grey</i>	1	20			
	45PB04NL	Nero lucido <i>Polished black</i>	1	20			

Armatura da utilizzare
To be used with

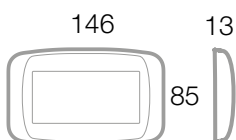

45764

Placche in tecnopolimero "Banquise" per scatola rettangolare "Banquise" moulded front plates for rectangular boxes

6 MODULI / 6 MODULES		Cod. Code	Descrizione Description	Info	€	<input type="checkbox"/>	<input type="checkbox"/>
 	45PB06BB	Bianco Banquise (RAL 9016) <i>Banquise white (RAL 9016)</i>	1	15			
	45PB06BP	Bianco Blanc (RAL 1013) <i>Blanc white (RAL 1013)</i>	1	15			
	45PB06GSM	Grigio scuro metallizzato <i>Metallic dark grey</i>	1	15			
	45PB06NL	Nero lucido <i>Polished black</i>	1	15			

Armatura da utilizzare
To be used with

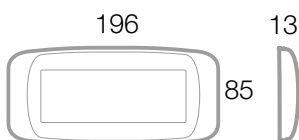

45366

Le dimensioni, salvo diversamente specificato, sono in mm
Dimensions, except where otherwise specified, are in mm

Prodotto per scatola quadrata
Product for British Standard square box only

Prodotto 1 modulo installabile in scatola tonda con altro prodotto 1 modulo
1 module product installable in round box with another 1 module device

Imballo Minimo pcs
Min. Packaging pcs

Imballo Standard pcs
Std. Packaging pcs



Placche in metallo "Zama 45" per scatola rettangolare
"Zama 45" metal front plates for rectangular boxes

Design:
M. Hasuike

334

3 MODULI / 3 MODULES

Cod. Code Descrizione Description

Info

€ □ □



45P93AM



45P93BG



45P93BM



45P93CR



45P93NO



45P93BMC



45P93BP



45P93TI



45P93GSM



45P93NL



45P93TT

Cod. Code	Descrizione Description	Info	€	□	□
45P93AM	Argento metallizzato Metallic silver		1	15	
45P93BG	Bianco Banquise (RAL 9016) Banquise white (RAL 9016)		1	15	
45P93BM	Blu marine Navy blue		1	15	
45P93BMC	Bianco Banquise micalizzato Mica-finished Banquise white		1	15	
45P93BP	Bianco Blanc (RAL 1013) Blanc white (RAL 1013)		1	15	
45P93CR	Cromo Chrome		1	15	
45P93GSM	Grigio scuro metallizzato Metallic dark grey		1	15	
45P93NL	Nero lucido Polished black		1	15	
45P93TI	Titanio Titanium		1	15	
45P93TT	Ottone lucido Polished brass		1	15	

Nota: 45P93TT base in zama come per tutti gli altri colori

Note: 45P93TT zama base as all the other colours

Placche "antisalinità"

L'installazione in ambienti soggetti all'influenza del mare (ad esempio le imbarcazioni) o con presenza di soluzioni saline, può provocare, alle normali placche, un precoce deterioramento della verniciatura. Per ovviare a questo problema Ave ha inserito le "placche antisalinità" che, grazie ad un rivoluzionario processo di verniciatura, garantiscono una maggior resistenza nel tempo alla finitura originale.

Ave offre la possibilità di avere questo trattamento solo sulle seguenti 5 colorazioni: bianco Banquise (BG), bianco Blanc (BP), cromo (CR), ottone (TT), radica (RD).

Modalità di ordinazione: indicare nell'ordine, dopo il codice della placca desiderata, "con trattamento antisalinità".

Anti-salinity front plates

The installation in environments close to the sea (for example the boats) or where salt solutions are present, can cause a premature deterioration of the paint in normal kind of front plates.

In order to solve this problem, Ave proposes the anti-salinity front plates: thanks to a revolutionary process of paint, they guarantee a greater resistance through the time.

Ave can offer this special paint in the following colours: Banquise white (BG), Blanc white (BP), Chrome (CR), Brass (TT), Briarwood (RD). How to order them: indicate on your purchase order "with anti-salinity treatment" after the front plate code.

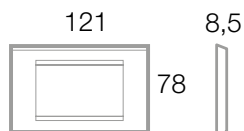

Armatura da utilizzare
To be used with



45B63



Per la disponibilità contattare la rete commerciale
For availability please contact sales dept.



Disponibilità fino ad esaurimento scorte
Available until stock out



Prodotto 2 moduli adatto anche per scatola tonda
2 modules product suitable for round box



Prodotto per scatola rettangolare inglese
Product for British standard rectangular box





Prodotto per Export
For Export only

Placche in metallo "Zama 45" per scatola rettangolare

"Zama 45" metal front plates for rectangular boxes

Design:
M. Hasuike

4 MODULI / 4 MODULES	Cod. Code	Descrizione Description	Info	€	□ □	335
 	45P94AM	Argento metallizzato <i>Metallic silver</i>		1	14	
	45P94BG	Bianco Banquise (RAL 9016) <i>Banquise white (RAL 9016)</i>		1	14	
	45P94BM	Blu marine <i>Navy blue</i>		1	14	
	45P94BP	Bianco Blanc (RAL 1013) <i>Blanc white (RAL 1013)</i>		1	14	
	45P94CR	Cromo <i>Chrome</i>		1	14	
	45P94GSM	Grigio scuro metallizzato <i>Metallic dark grey</i>		1	14	
	45P94NL	Nero lucido <i>Polished black</i>		1	14	
	45P94TI	Titanio <i>Titanium</i>		1	14	

Armatura da utilizzare
To be used with



45764

Placche in metallo "Zama 45" per scatola rettangolare

"Zama 45" metal front plates for rectangular boxes

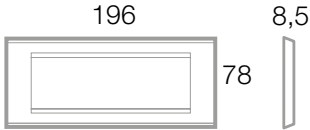
6 MODULI / 6 MODULES	Cod. Code	Descrizione Description	Info	€	□ □
 	45P96AM	Argento metallizzato <i>Metallic silver</i>		1	10
	45P96BG	Bianco Banquise (RAL 9016) <i>Banquise white (RAL 9016)</i>		1	10
	45P96BMC	Bianco Banquise micalizzato <i>Mica-finished Banquise white</i>		1	10
	45P96BP	Bianco Blanc (RAL 1013) <i>Blanc white (RAL 1013)</i>		1	10
	45P96CR	Cromo <i>Chrome</i>		1	10
	45P96GSM	Grigio scuro metallizzato <i>Metallic dark grey</i>		1	10
	45P96NC	Nichel <i>Nickel</i>		1	10
	45P96NL	Nero lucido <i>Polished black</i>		1	10
	45P96TI	Titanio <i>Titanium</i>		1	10
	45P96TT	Ottone lucido <i>Polished brass</i>		1	10

Armatura da utilizzare
To be used with



45366

Nota: 45P96TT base in Zama come per tutti gli altri colori
Note: 45P96TT Zama base as all the other colours

Le dimensioni, salvo diversamente specificato, sono in mm
Dimensions, except where otherwise specified, are in mm

◆ Prodotto per scatola quadrata
Product for British Standard
square box only

② Prodotto 1 modulo installabile in scatola tonda
con altro prodotto 1 modulo
1 module product installable in round box with
another 1 module device

□ Imballo Minimo pcs
Min. Packaging pcs

□ Imballo Standard pcs
Std. Packaging pcs



Sequenza installativa *Installation examples*

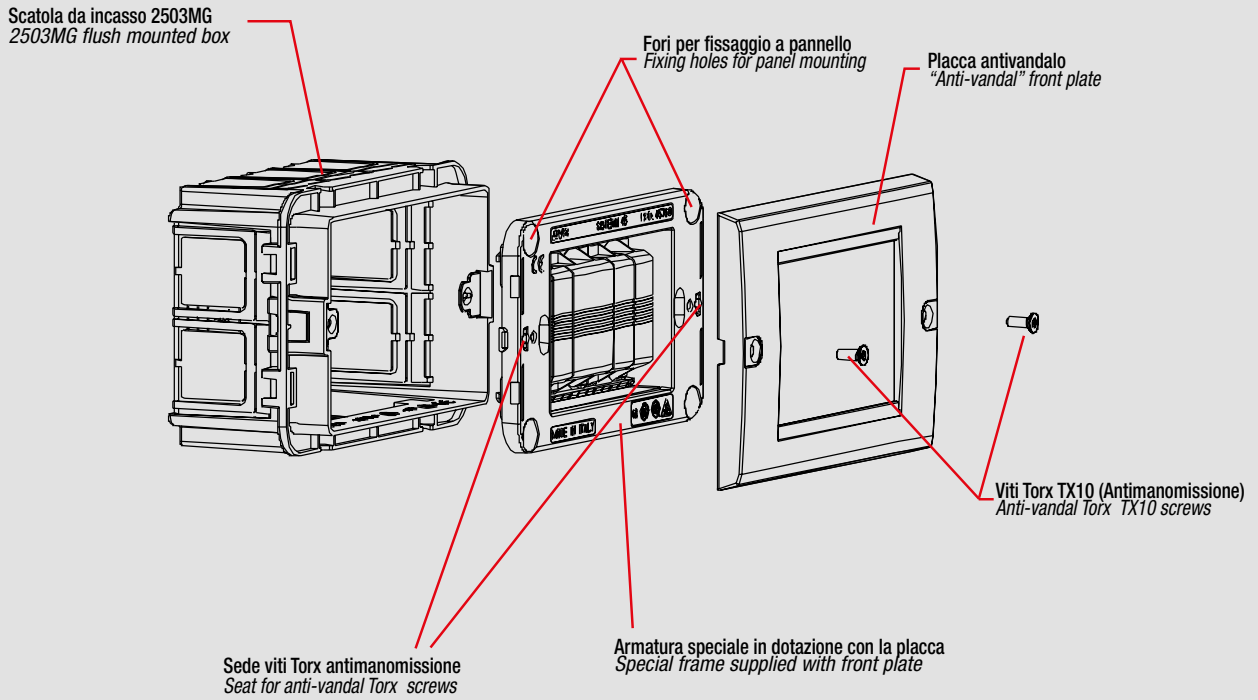

Dettaglio attrezzo rimozione viti *Screw removal tool detail*

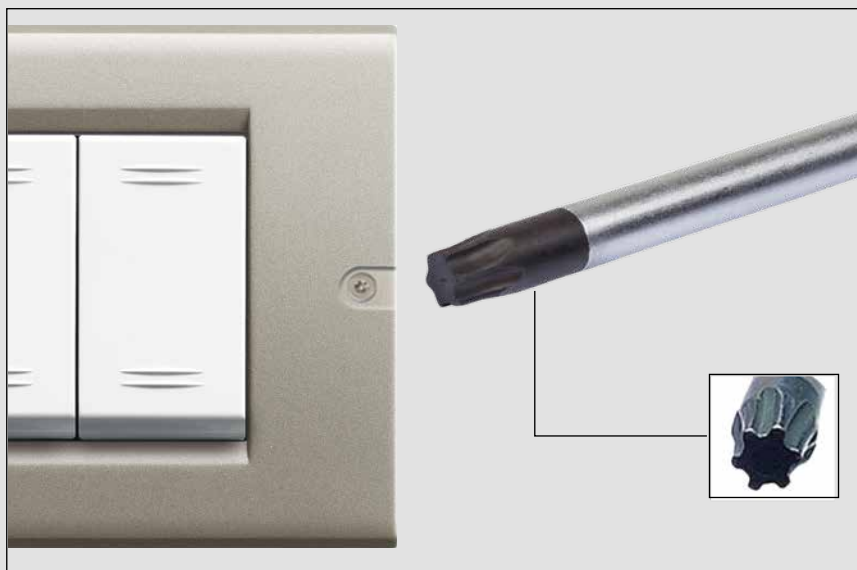

N.B. Chiave a Torx non in dotazione
N.B. Torx key not supplied



Per la disponibilità contattare la rete commerciale
For availability please contact sales dept.



Disponibilità fino ad esaurimento scorte
Available until stock out



Prodotto 2 moduli adatto anche per scatola tonda
2 modules product suitable for round box



Prodotto per scatola rettangolare inglese
Product for British standard rectangular box



Prodotto per Export
For Export only

Placche in metallo "antivandalo" per scatole rettangolari "Anti-vandal" metal front plates for rectangular boxes

Design:
M. Hasuike

Cod. Code	Descrizione Description	Info	€	□	□
45P93TIAV	Placca "antivandalo" 3 moduli - fissaggio all'armatura con viti speciali che non permettono il distacco della placca se non con l'utilizzo di un apposito attrezzo - fornita con armatura speciale - colore titanio <i>"Anti-vandal" front plate 3 modules - particular fixing system to the frame with special screws that do not allow to remove the plate except by an appropriate tool - provided with special frame - brushed nickel colour</i>	1	1		
45P94TIAV	Placca "antivandalo" 4 moduli - fissaggio all'armatura con viti speciali che non permettono il distacco della placca se non con l'utilizzo di un apposito attrezzo - fornita con armatura speciale - colore titanio <i>"Anti-vandal" front plate 4 modules - particular fixing system to the frame with special screws that do not allow to remove the plate except by an appropriate tool - provided with special frame - titanium colour</i>	1	1		



45P93TIAV

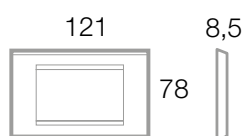

45P94TIAV

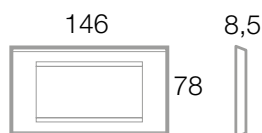

Nota: fornite con armatura speciale

Note: supplied with special frame

Accessori Accessories

Descrizione Description	Info	€	□	□
25GS Ganci metallici di ricambio per scatole porta frutti 3 e 4 moduli <i>Spare metallic hooks for 3 and 4 modules boxes</i>	10	10		



25GS

Le dimensioni, salvo diversamente specificato, sono in mm
Dimensions, except where otherwise specified, are in mm

◇ Prodotto per scatola quadrata
Product for British Standard square box only

② Prodotto 1 modulo installabile in scatola tonda con altro prodotto 1 modulo
1 module product installable in round box with another 1 module device

□ Imballo Minimo pcs
Min. Packaging pcs

□ Imballo Standard pcs
Std. Packaging pcs



Placche

Front Plates

Sistema 45

Placche in metallo MAXIMODULO "Zama 45" "Zama 45" MAXI MODULE metal front plates

Design:
M. Hasuike

338



45P910...

Cod. Code	Descrizione Description	Info	€	□	□
45P910BP	10 moduli bianco Blanc (RAL 1013) 10 modules Blanc white (RAL 1013)	1	1		
45P915BG	15 moduli bianco Banquise (RAL 9016) 15 modules Banquise white (RAL 9016)	1	1		

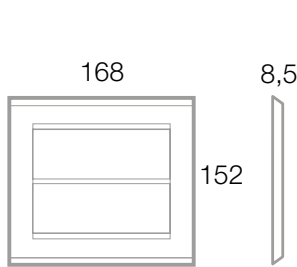

Armatura da utilizzare
To be used with



45760/10

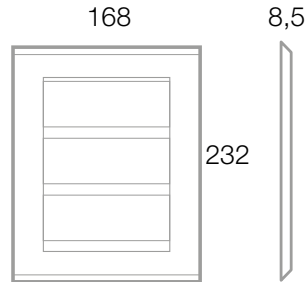

Armatura da utilizzare
To be used with

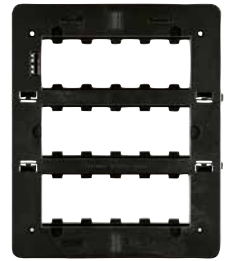

45760/15

Placche in tecnopolimero MAXIMODULO MAXI MODULE moulded front plates

10 (5+5) MODULI / 10 (5+5) MODULES



45P010...

Cod. Code	Descrizione Description	Info	€	□	□
45P010BG	Bianco Banquise (RAL 9016) Banquise white (RAL 9016)	1	5		
45P010GM	Grigio metallizzato Metallic grey	1	5		
45P010R	Grigio RAL 7035 RAL 7035 grey	1	5		

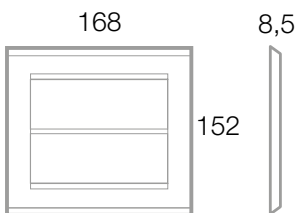

Armatura da utilizzare
To be used with



45760/10



Per la disponibilità contattare la rete commerciale
For availability please contact sales dept.



Disponibilità fino ad esaurimento scorte
Available until stock out



Prodotto 2 moduli adatto anche per scatola tonda
2 modules product suitable for round box



Prodotto per scatola rettangolare inglese
Product for British standard rectangular box



Prodotto per Export
For Export only

Placche in tecnopolimero "Spring" per scatola rettangolare "Spring" series moulded front plates - rectangular box

Design:
L. Merletti

3 MODULI / 3 MODULES		Cod. Code	Descrizione Description	Info	€	□	□	339
		45PS03ARB	Ambra brillante Bright amber		1	25		
		45PS03CNR	Cenere Ash grey		1	25		
		Armatura da utilizzare To be used with 						
		45B63						

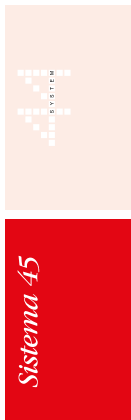

Placche in tecnopolimero "Spring" per scatola rettangolare "Spring" series moulded front plates - rectangular box

4 MODULI / 4 MODULES		Cod. Code	Descrizione Description	Info	€	□	□
		45PS04ARB	Ambra brillante Bright amber		1	20	
		45PS04CNR	Cenere Ash grey		1	20	
		45PS04RBN	Rubino Ruby		1	20	
		Armatura da utilizzare To be used with 					
		45364					

Placche in tecnopolimero "Spring" per scatola rettangolare "Spring" series moulded front plates - rectangular box

6 MODULI / 6 MODULES		Cod. Code	Descrizione Description	Info	€	□	□
		45PS06ARB	Ambra brillante Bright amber		1	15	
		45PS06CNR	Cenere Ash grey		1	15	
		45PS06RBN	Rubino Ruby		1	15	
		Armatura da utilizzare To be used with 					
		45366					

Le dimensioni, salvo diversamente specificato, sono in mm
Dimensions, except where otherwise specified, are in mm

 Prodotto per scatola quadrata
Product for British Standard square box only

 Prodotto 1 modulo installabile in scatola tonda con altro prodotto 1 modulo
1 module product installable in round box with another 1 module device

 Imballo Minimo pcs
Min. Packaging pcs

 Imballo Standard pcs
Std. Packaging pcs



Placche

Front Plates

Sistema 45

Placche in tecnopolimero "Yes 45" per scatola rettangolare
 "Yes 45" series moulded front plates - rectangular box

Design:
H. M. R.

340

3 MODULI / 3 MODULES

Cod. Code Descrizione Description

Info

€ □ □



45PY03AO



45PY03BB

45PY03AO Argento opaco
Matt silver

1 25

45PY03BB Bianco Banquise (RAL 9016)
Banquise white (RAL 9016)

1 25

45PY03BP Bianco Blanc (RAL1013)
Blanc white (RAL 1013)

1 25

45PY03CHO Champagne opaco
Champagne

1 25

45PY03GN Grigio Noir
Noir grey

1 25



45PY03CHO



45PY03GN

45PY03GSM Grigio scuro metallizzato
Metallic dark grey

1 25

45PY03OT Ottone lucido
Polished brass

1 25



45PY03OT



45PY03GSM



45PY03BP

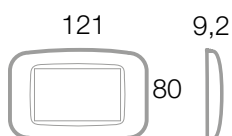

Armatura da utilizzare

To be used with



45B63



Per la disponibilità contattare la rete commerciale
For availability please contact sales dept.



Disponibilità fino ad esaurimento scorte
Available until stock out



Prodotto 2 moduli adatto anche per scatola tonda
2 modules product suitable for round box



Prodotto per scatola rettangolare inglese
Product for British standard rectangular box



Prodotto per Export
For Export only

Placche in tecnopolimero "Yes 45" per scatola rettangolare

"Yes 45" series moulded front plates - rectangular box

Design:
H. M. R.

341

1 MODULO / 1 MODULE



Cod. Code	Descrizione Description	Info	€	□	□
45PY01BB	Bianco Banquise (RAL 9016) <i>Banquise white (RAL 9016)</i>	1	25		
45PY01BP	Bianco Blanc (RAL 1013) <i>Blanc white (RAL 1013)</i>	1	25		
45PY01GN	Grigio Noir <i>Noir grey</i>	1	25		

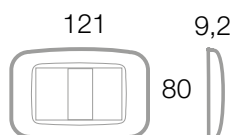

45B63

Armatura da utilizzare
To be used with

Placche in tecnopolimero "Yes 45" per scatola rettangolare

"Yes 45" series moulded front plates - rectangular box

2 (1+1) MODULI / 2 (1+1) MODULES



Cod. Code	Descrizione Description	Info	€	□	□
45PY002BB	Bianco Banquise (RAL 9016) <i>Banquise white (RAL 9016)</i>	1	25		
45PY002BP	Bianco Blanc (RAL 1013) <i>Blanc white (RAL 1013)</i>	1	25		
45PY002CR	Cromo <i>Chrome</i>	1	25		
45PY002GN	Grigio Noir <i>Noir grey</i>	1	25		

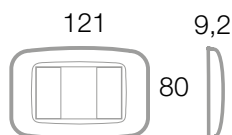

45B63

Armatura da utilizzare
To be used with

Placche in tecnopolimero "Yes 45" per scatola rettangolare

"Yes 45" series moulded front plates - rectangular box

2 MODULI / 2 MODULES



Cod. Code	Descrizione Description	Info	€	□	□
45PY02BB	Bianco Banquise (RAL 9016) <i>Banquise white (RAL 9016)</i>	1	25		
45PY02BP	Bianco Blanc (RAL 1013) <i>Blanc white (RAL 1013)</i>	1	25		
45PY02GN	Grigio Noir <i>Noir grey</i>	1	25		
45PY020T	Ottone lucido <i>Polished brass</i>	1	25		

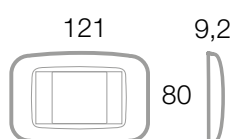

45762



45B63

Armatura da utilizzare
To be used with

Nota: con l'armatura 45B63 sono installabili centralmente solo i prodotti del Sistema 45 contrassegnati, nella colonna "Info", con i simboli • e ②

Note: with the 45B63 frame, only system 45 products with the symbols • and ② in the "info" column can be installed centrally

Le dimensioni, salvo diversamente specificato, sono in mm
Dimensions, except where otherwise specified, are in mm

◆ Prodotto per scatola quadrata
Product for British Standard
square box only

② Prodotto 1 modulo installabile in scatola tonda
con altro prodotto 1 modulo
1 module product installable in round box with
another 1 module device

□ Imballo Minimo pcs
Min. Packaging pcs

□ Imballo Standard pcs
Std. Packaging pcs



Placche

Front Plates

Sistema 45

Placche in tecnopolimero "Yes 45" per scatola rettangolare

"Yes 45" series moulded front plates - rectangular box

Design:
H. M. R.

342

4 MODULI / 4 MODULES

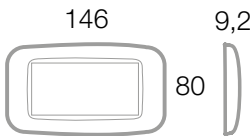

Armatura da utilizzare
To be used with



45764

Cod. Code	Descrizione Description	Info	€	□	□
45PY04AO	Argento opaco Matt silver	1	20		
45PY04AS	Argento satinato Satin silver	1	20		
45PY04BB	Bianco Banquise (RAL 9016) Banquise white (RAL 9016)	1	20		
45PY04BP	Bianco Blanc (RAL 1013) Blanc white (RAL 1013)	1	20		
45PY04CHO	Champagne opaco Champagne	1	20		
45PY04GN	Grigio Noir Noir grey	1	20		
45PY04GSM	Grigio scuro metallizzato Metallic dark grey	1	20		
45PY04OT	Ottone lucido Polished brass	1	20		

Placche in tecnopolimero "Yes 45" per scatola rettangolare

"Yes 45" series moulded front plates - rectangular box

6 MODULI / 6 MODULES

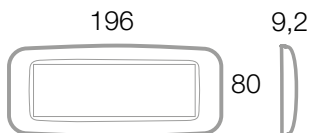

Armatura da utilizzare
To be used with



45366

Cod. Code	Descrizione Description	Info	€	□	□
45PY06AO	Argento opaco Matt silver	1	15		
45PY06AS	Argento satinato Satin silver	1	15		
45PY06BB	Bianco Banquise (RAL 9016) Banquise white (RAL 9016)	1	15		
45PY06BP	Bianco Blanc (RAL 1013) Blanc white (RAL 1013)	1	15		
45PY06CHO	Champagne opaco Champagne	1	15		
45PY06GN	Grigio Noir Noir grey	1	15		
45PY06GSM	Grigio scuro metallizzato Metallic dark grey	1	15		
45PY06OT	Ottone lucido Polished brass	1	15		
45PY06RD	Radica lucida Polished briarwood	1	15		



Per la disponibilità contattare la rete commerciale
For availability please contact sales dept.



Disponibilità fino ad esaurimento scorte
Available until stock out



Prodotto 2 moduli adatto anche per scatola tonda
2 modules product suitable for round box



Prodotto per scatola rettangolare inglese
Product for British standard rectangular box



Prodotto per Export
For Export only

Placche in tecnopolimero "Yes 45" per scatola tonda o quadrata

"Yes 45" series moulded front plates - square or round box

Design:
H. M. R.

2 MODULI / 2 MODULES	Cod. Code	Descrizione Description	Comicetta Adapter frame	Info	€	<input type="checkbox"/>	<input type="checkbox"/>
	45P22BB	Bianco Banquise (RAL 9016) <i>Banquise white (RAL 9016)</i>	Bianco Banquise (RAL 9016) <i>Banquise white (RAL 9016)</i>	1	30		
	45P22BP	Bianco blanc (RAL 1013) <i>Blanc white (RAL 1013)</i>	Bianco Blanc (RAL 1013) <i>Blanc white (RAL 1013)</i>	1	30		
	45P22GSM	Grigio scuro metallizzato <i>Metallic dark grey</i>	Grigio scuro metallizzato <i>Metallic dark grey</i>	1	30		

45P22BB



45P22BP



45P22GSM

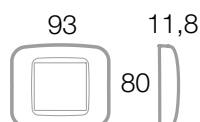

Armatura da utilizzare
To be used with

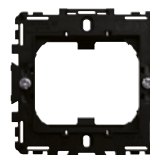

45362EX

Placche in tecnopolimero "Yes 45" per scatola tonda o quadrata

"Yes 45" series moulded front plates - square or round box

1 MODULO / 1 MODULE	Cod. Code	Descrizione Description	Comicetta Adapter frame	Info	€	<input type="checkbox"/>	<input type="checkbox"/>
	45P21BB	Bianco Banquise (RAL 9016) <i>Banquise white (RAL 9016)</i>	Bianco Banquise (RAL 9016) <i>Banquise white (RAL 9016)</i>	1	30		
	45P21BP	Bianco blanc (RAL 1013) <i>Blanc white (RAL 1013)</i>	Bianco Blanc (RAL 1013) <i>Blanc white (RAL 1013)</i>	1	30		
	45P21GN	Grigio Noir <i>Noir grey</i>	Grigio Noir <i>Noir grey</i>	1	30		
	45P21GSM	Grigio scuro metallizzato <i>Metallic dark grey</i>	Grigio Noir <i>Noir grey</i>	1	30		
	45P21OT	Ottone lucido <i>Polished brass</i>	Grigio Noir <i>Noir grey</i>	1	30		

Armatura da utilizzare
To be used with

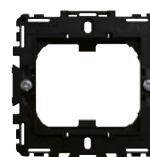
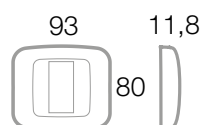

45362EX

Le dimensioni, salvo diversamente specificato, sono in mm
Dimensions, except where otherwise specified, are in mm

Prodotto per scatola quadrata
Product for British Standard
square box only

Prodotto 1 modulo installabile in scatola tonda
con altro prodotto 1 modulo
1 module product installable in round box with
another 1 module device

Imballo Minimo pcs
Min. Packaging pcs

Imballo Standard pcs
Std. Packaging pcs



Placche

Front Plates

Sistema 45

Placche in tecnopolimero "Yes 45" per scatola tonda o quadrata
 "Yes 45" series moulded front plates - square or round box

Design:
H. M. R.

344

4(2+2) MODULI / 4(2+2) MODULES



Cod. Code	Descrizione Description	Cornicetta Adapter frame	Info	€	□	□
45P24BB	Bianco Banquise (RAL 9016) Banquise white (RAL 9016)	Bianco Banquise (RAL 9016) Banquise white (RAL 9016)	1	15		
45P24BP	Bianco blanc (RAL 1013) Blanc white (RAL 1013)	Bianco Blanc (RAL 1013) Blanc white (RAL 1013)	1	15		
45P24GN	Grigio Noir Noir grey	Grigio Noir Noir grey	1	15		

Installazione orizzontale o
verticale
Horizontal and vertical
installation

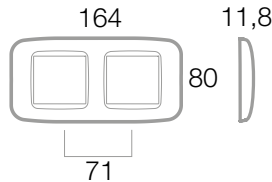

Armatura da utilizzare
To be used with

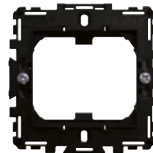

n° 2 45362EX

Placche in tecnopolimero "Yes 45" per scatola tonda o quadrata
 "Yes 45" series moulded front plates - square or round box

6(2+2+2) MODULI / 6(2+2+2) MODULES



Cod. Code	Descrizione Description	Cornicetta Adapter frame	Info	€	□	□
45P26BB	Bianco Banquise (RAL 9016) Banquise white (RAL 9016)	Bianco Banquise (RAL 9016) Banquise white (RAL 9016)	1	30		
45P26BP	Bianco blanc (RAL 1013) Blanc white (RAL 1013)	Bianco Blanc (RAL 1013) Blanc white (RAL 1013)	1	30		
45P26GN	Grigio Noir Noir grey	Grigio Noir Noir grey	1	30		

Installazione orizzontale o
verticale
Horizontal and vertical
installation

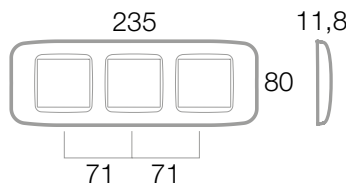

Armatura da utilizzare
To be used with

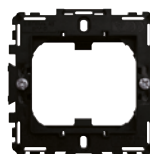

n° 3 45362EX



Per la disponibilità contattare
la rete commerciale
For availability please contact
sales dept.



Disponibilità fino ad
esaurimento scorte
Available until stock out



Prodotto 2 moduli adatto
anche per scatola tonda
2 modules product suitable
for round box



Prodotto per scatola
rettangolare inglese
Product for British standard
rectangular box



Prodotto
per Export
For Export
only

Accessori placche in tecnopolimero "Yes 45" per scatola tonda o quadrata

"Yes 45" series moulded front plates accessories - square or round box

Design:
H. M. R.

1 MODULO / 1 MODULE	Cod. Code	Descrizione Description	Info	€	<input type="checkbox"/>	<input type="checkbox"/>
	45CR1BB	Cornice di ricambio 1 mod. color Banquise (RAL 9016) <i>Banquise white (RAL 9016) 1 module spare adapter frame</i>		5	100	
	45CR1BP	Cornice di ricambio 1 mod. color Blanc (RAL 1013) <i>Blanc (RAL 1013) white 1 module spare adapter frame</i>		5	100	
	45CR1GN	Cornice di ricambio 1 mod. color grigio Noir <i>Noir grey 1 module spare adapter frame</i>		5	100	

345

Sistema 45

Accessori placche in tecnopolimero "Yes 45" per scatola tonda o quadrata

"Yes 45" series moulded front plates accessories - square or round box

2 MODULI / 2 MODULES	Cod. Code	Descrizione Description	Info	€	<input type="checkbox"/>	<input type="checkbox"/>
	45CR2BB	Cornice di ricambio 2 mod. color Banquise (RAL 9016) <i>Banquise (RAL 9016)white 2 modules spare adapter frame</i>		5	100	
	45CR2BP	Cornice di ricambio 2 mod. color Blanc (RAL 1013) <i>Blanc (RAL 1013) white 2 modules spare adapter frame</i>		5	100	
	45CR2GN	Cornice di ricambio 2 mod. color grigio Noir <i>Noir grey 2 modules spare adapter frame</i>		5	100	

Sequenza di assemblaggio Installation

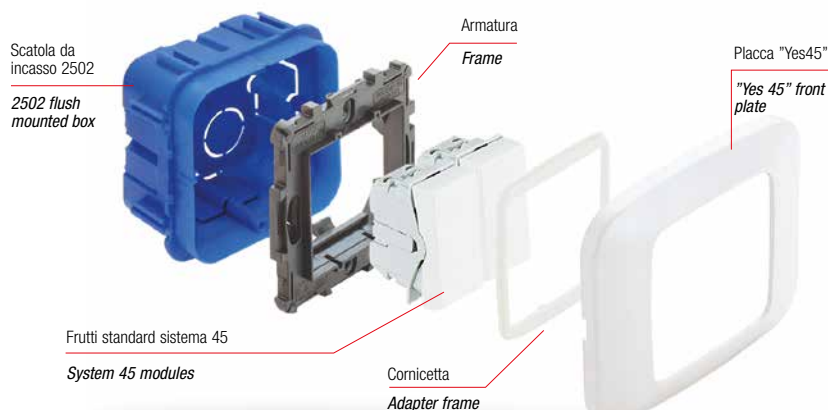

Le dimensioni, salvo diversame
Dimensions, except where ott

Prodotto per scatola quadrata
Product for British Standard square box only

Prodotto 1 modulo installabile in scatola tonda con altro prodotto 1 modulo
1 module product installable in round box with another 1 module device

Imballo Minimo pcs
Min. Packaging pcs

Imballo Standard pcs
Std. Packaging pcs



Placche

Front Plates

Sistema 45

Placche in tecnopolimero "Mini 45" per pannelli/profilati

"Mini 45" moulded front plates for section bars

Design:
H. M. R.

346

1 MODULO / 1 MODULE

Cod. Code Descrizione Description

Info

€ □ □



45PF1A0

45PF1A0 Argento Opaco
Matt silver

1 50

45PF1BB Bianco Banquise (RAL 9016)
Banquise white (RAL 9016)

1 50



45PF1BB

Armatura da utilizzare
To be used with

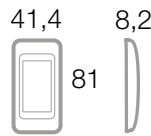

45B61

Placche in tecnopolimero "Mini 45" per pannelli/profilati

"Mini 45" moulded front plates for section bars

2 (1+1) MODULI / 2 (1+1) MODULES

Cod. Code Descrizione Description

Info

€ □ □



45PF2A0 Argento Opaco
Matt silver

1 30

45PF2BB Bianco Banquise (RAL 9016)
Banquise white (RAL 9016)

1 30

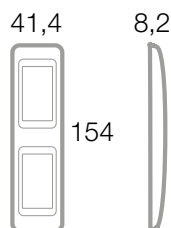

Armatura da utilizzare
To be used with



n° 2 45B61



Per la disponibilità contattare la rete commerciale
For availability please contact sales dept.



Disponibilità fino ad esaurimento scorte
Available until stock out



Prodotto 2 moduli adatto anche per scatola tonda
2 modules product suitable for round box



Prodotto per scatola rettangolare inglese
Product for British standard rectangular box



Prodotto per Export
For Export only

Placche in tecnopolimero multimodulo "Maxi Yes" per scatola BL02P
Multi-module "Maxi Yes" series moulded front plates - for BL02P box

Design:
H. M. R.

6 (3+3) MODULI / 6 (3+3) MODULES	Cod. Code	Descrizione Description	Info	€	<input type="checkbox"/>	<input type="checkbox"/>
	45PY033A0	Argento Opaco Matt silver		1	10	
	45PY033BB	Bianco Banquise (RAL 9016) Banquise white (RAL 9016)		1	10	

45PY033A0



45PY033BB

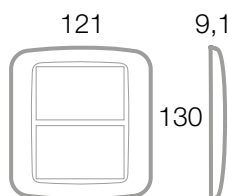

Armatura da utilizzare
To be used with



45B66

Placche in tecnopolimero multimodulo "Maxi Yes" per scatole BL05P e BL05CG
Multi-module "Maxi Yes" series moulded front plates - for BL05P and BL05CG box

10 (5+5) MODULI / 10 (5+5) MODULES	Cod. Code	Descrizione Description	Info	€	<input type="checkbox"/>	<input type="checkbox"/>
	45PY010BB	Bianco Banquise (RAL 9016) Banquise white (RAL 9016)		1	10	
	45PY010BP	Bianco Blanc (RAL 1013) Blanc white (RAL 1013)		1	10	

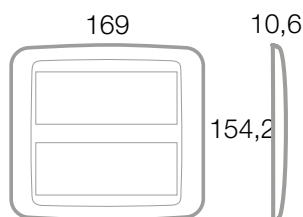

Armatura da utilizzare
To be used with



45760/10

Le dimensioni, salvo diversamente specificato, sono in mm
 Dimensions, except where otherwise specified, are in mm

Prodotto per scatola quadrata
Product for British Standard square box only

Prodotto 1 modulo installabile in scatola tonda con altro prodotto 1 modulo
1 module product installable in round box with another 1 module device

Imballo Minimo pcs
Min. Packaging pcs

Imballo Standard pcs
Std. Packaging pcs



Placche

Front Plates

Sistema 45

Placche in tecnopolimero "Maxi Yes" multimodulo

Multi-module "Maxi Yes" series moulded front plates

Design:
H. M. R.

348

20 (5+5+5+5) MODULI / 20 (5+5+5+5) MODULES



Cod. Code	Descrizione Description	Info	€	□	□
45PY020BB	Bianco Banquise (RAL 9016) <i>Banquise white (RAL 9016)</i>	1	16		
45PY020BP	Bianco Blanc (RAL 1013) <i>Blanc white (RAL 1013)</i>	1	16		
45PY020CHO	Champagne opaco <i>Champagne</i>	1	16		

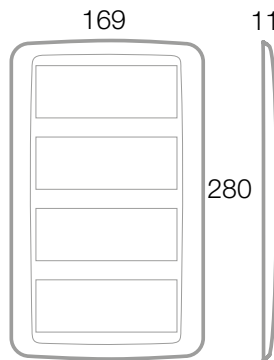

Armatura da utilizzare
To be used with



45760/20

Placche in tecnopolimero "Maxi Yes" multimodulo

Multi-module "Maxi Yes" series moulded front plates

10 MOD. (5+5) + 6 MOD. DIN / 10 MODULES (5+5) + 6 DIN MOD.



Cod. Code	Descrizione Description	Info	€	□	□
45PY10DINBB	Bianco Banquise (RAL 9016) <i>Banquise white (RAL 9016)</i>	1	16		
45PY10DINGSM	Grigio scuro metallizzato <i>Metallic dark grey</i>	1	16		

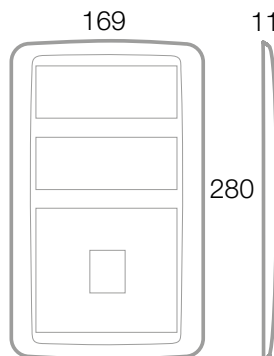

Armatura da utilizzare
To be used with



45760/20



Per la disponibilità contattare la rete commerciale
For availability please contact sales dept.



Disponibilità fino ad esaurimento scorte
Available until stock out



Prodotto 2 moduli adatto anche per scatola tonda
2 modules product suitable for round box



Prodotto per scatola rettangolare inglese
Product for British standard rectangular box



Prodotto per Export
For Export only

Placche in tecnopolimero "Maxi Yes" per scatola BL06P (Speciale per touch screen TS02)
"Maxi Yes" moulded front plates for BL06P (Special for Touch Screen TS02)

Design:
H. M. R.

Cod. Code	Descrizione Description	Info	€	□	□
-----------	-------------------------	------	---	---	---

349



45PY015BB-TS	Bianco Banquise (RAL 9016) Banquise white (RAL 9016)			1	16
--------------	---	--	--	---	----

Nota: prodotti per ricambistica
Note: spare parts products

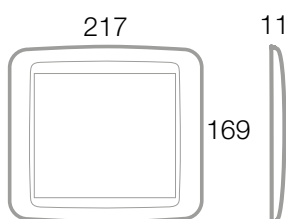

Placche autoportanti in tecnopolimero "Yesmin" "Yesmin" series self-supporting moulded front plates

1 MODULO / 1 MODULE	Cod. Code	Descrizione Description	Info	€	□	□
---------------------	-----------	-------------------------	------	---	---	---



45PA1BB

45PA1BB	Bianco Banquise (RAL 9016) Banquise white (RAL 9016)			10	10
---------	---	--	--	----	----

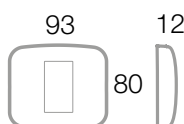

Placche autoportanti in tecnopolimero "Yesmin" "Yesmin" series self-supporting moulded front plates

2 MODULI / 2 MODULES	Cod. Code	Descrizione Description	Info	€	□	□
----------------------	-----------	-------------------------	------	---	---	---



45PA2BB	Bianco Banquise (RAL 9016)- con griffe Banquise white (RAL 9016) - with clips			10	10
45PA2BP	Bianco Blanc (RAL 1013) - con griffe Blanc white (RAL 1013) - with clips			10	10

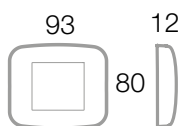

Le dimensioni, salvo diversamente specificato, sono in mm
 Dimensions, except where otherwise specified, are in mm

◆ Prodotto per scatola quadrata
 Product for British Standard square box only

② Prodotto 1 modulo installabile in scatola tonda con altro prodotto 1 modulo
 1 module product installable in round box with another 1 module device

□ Imballo Minimo pcs
 Min. Packaging pcs

□ Imballo Standard pcs
 Std. Packaging pcs



Placche

Front Plates

Sistema 45

Placche in tecnopolimero "Ral 45" sabbiate

"Ral 45" matt finish moulded front plates

Design:
H. M. R.

350

3 MODULI / 3 MODULES



45P03BP



45P03R

Cod. Code	Descrizione Description	Info	€	□	□
45P03BP	Bianco Blanc (RAL 1013) Blanc white (RAL 1013)	1	25		
45P03GN	Grigio Noir Noir grey	1	25		
45P03R	Grigio RAL 7035 7035 RAL grey	1	25		



45P03GN

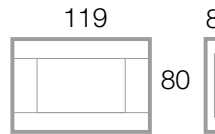

Armatura da utilizzare
To be used with



45B63

Placche in tecnopolimero "Ral 45" sabbiate "Ral 45" matt finish moulded front plates

1 MODULO / 1 MODULE



Cod. Code	Descrizione Description	Info	€	□	□
45P01BP	Bianco Blanc (RAL 1013) Blanc white (RAL 1013)	1	25		
45P01GN	Grigio Noir Noir grey	1	25		
45P01R	Grigio RAL 7035 7035 RAL grey	1	25		

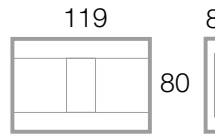

Armatura da utilizzare
To be used with



45B63

Placche in tecnopolimero "Ral 45" sabbiate "Ral 45" matt finish moulded front plates

2 (1+1) MODULI / 2 (1+1) MODULES



Cod. Code	Descrizione Description	Info	€	□	□
45P002BP	Bianco Blanc (RAL 1013) Blanc white (RAL 1013)	1	25		
45P002GN	Grigio Noir Noir grey	1	25		
45P002R	Grigio RAL 7035 7035 RAL grey	1	25		

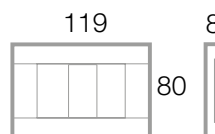

Armatura da utilizzare
To be used with



45B63



Per la disponibilità contattare la rete commerciale
For availability please contact sales dept.



Disponibilità fino ad esaurimento scorte
Available until stock out



Prodotto 2 moduli adatto anche per scatola tonda
2 modules product suitable for round box



Prodotto per scatola rettangolare inglese
Product for British standard rectangular box



Prodotto per Export
For Export only

Placche in tecnopolimero "Ral 45" sabbiato "Ral 45" matt finish moulded front plates

Design:
H. M. R.

2 MODULI / 2 MODULES	Cod. Code	Descrizione Description	Info	€	<input type="checkbox"/>	<input type="checkbox"/>
	45P02GN	Grigio Noir Noir grey		1	25	
	45P02R	Grigio RAL 7035 7035 RAL grey		1	25	

Armature da utilizzare To be used with

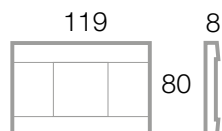

45762



45B63

Nota: con l'armatura 45B63 sono installabili centralmente solo i prodotti del Sistema 45 contrassegnati, nella colonna "Info", con i simboli • e ②

Note: with the 45B63 frame, only system 45 products with the symbols • and ② in the "info" column can be installed centrally

Placche in tecnopolimero "Ral 45" sabbiato "Ral 45" matt finish moulded front plates

4 MODULI / 4 MODULES	Cod. Code	Descrizione Description	Info	€	<input type="checkbox"/>	<input type="checkbox"/>
	45P04BP	Bianco Blanc (RAL 1013) Blanc white (RAL 1013)		1	20	
	45P04GN	Grigio Noir Noir grey		1	20	
	45P04R	Grigio RAL 7035 7035 RAL grey		1	20	

Armatura da utilizzare To be used with

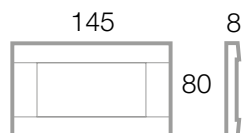

45764

Placche in tecnopolimero "Ral 45" sabbiato "Ral 45" matt finish moulded front plates

6 MODULI / 6 MODULES	Cod. Code	Descrizione Description	Info	€	<input type="checkbox"/>	<input type="checkbox"/>
	45P06BP	Bianco Blanc (RAL 1013) Blanc white (RAL 1013)		1	15	
	45P06GN	Grigio Noir Noir grey		1	15	
	45P06R	Grigio RAL 7035 7035 RAL grey		1	15	

Armatura da utilizzare To be used with

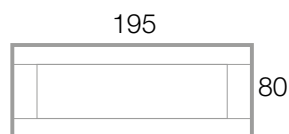

45366

Le dimensioni, salvo diversamente specificato, sono in mm
Dimensions, except where otherwise specified, are in mm

 Prodotto per scatola quadrata
Product for British Standard
square box only

② Prodotto 1 modulo installabile in scatola tonda
con altro prodotto 1 modulo
1 module product installable in round box with
another 1 module device

Imballo Minimo pcs
Min. Packaging pcs

Imballo Standard pcs
Std. Packaging pcs



Placche

Front Plates

Sistema 45

Placche in tecnopolimero "Ral 45" lucide "Ral 45" glossy finish moulded front plates

Design:
M. Hasuike

352

3 MODULI / 3 MODULES



45P03BG



45P03BL

Cod. Code	Descrizione Description	Info	€	□	□
45P03BG	Bianco Banquise (RAL 9016) <i>Banquise white (RAL 9016)</i>	1	25		
45P03BL	Bianco Blanc (RAL 1013) <i>Blanc white (RAL 1013)</i>	1	25		
45P03NL	Nero lucido <i>Polished black</i>	1	25		



45P03NL

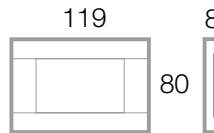

Armatura da utilizzare
To be used with



45B63

Placche in tecnopolimero "Ral 45" lucide "Ral 45" glossy finish moulded front plates

1 MODULO / 1 MODULE



Cod. Code	Descrizione Description	Info	€	□	□
45P01BG	Bianco Banquise (RAL 9016) <i>Banquise white (RAL 9016)</i>	1	25		
45P01BL	Bianco Blanc (RAL 1013) <i>Blanc white (RAL 1013)</i>	1	25		
45P01NL	Nero lucido <i>Polished black</i>	1	25		

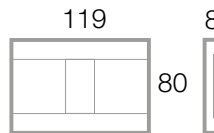

Armatura da utilizzare
To be used with



45B63

Placche in tecnopolimero "Ral 45" lucide "Ral 45" glossy finish moulded front plates

2 (1+1) MODULI / 2 (1+1) MODULES



Cod. Code	Descrizione Description	Info	€	□	□
45P002BG	Bianco Banquise (RAL 9016) <i>Banquise white (RAL 9016)</i>	1	25		
45P002BL	Bianco Blanc (RAL 1013) <i>Blanc white (RAL 1013)</i>	1	25		
45P002NL	Nero lucido <i>Polished black</i>	1	25		

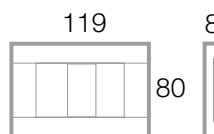

Armatura da utilizzare
To be used with



45B63



Per la disponibilità contattare la rete commerciale
For availability please contact sales dept.



Disponibilità fino ad esaurimento scorte
Available until stock out



Prodotto 2 moduli adatto anche per scatola tonda
2 modules product suitable for round box



Prodotto per scatola rettangolare inglese
Product for British standard rectangular box



Prodotto per Export
For Export only

Placche in tecnopolimero "Ral 45" lucide "Ral 45" glossy finish moulded front plates

Design:
M. Hasuike

353

2 MODULI / 2 MODULES	Cod. Code	Descrizione Description	Info	€	<input type="checkbox"/>	<input type="checkbox"/>
	45P02BG	Bianco Banquise (RAL 9016) Banquise white (RAL 9016)	1	25		
	45P02BL	Bianco Blanc (RAL 1013) Blanc white (RAL 1013)	1	25		

Armature da utilizzare To be used with

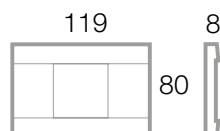

45762



45B63

Nota: con l'armatura 45B63 sono installabili centralmente solo i prodotti del Sistema 45 contrassegnati, nella colonna "Info", con i simboli • e ②

Note: with the 45B63 frame, only system 45 products with the symbols • and ② in the "info" column can be installed centrally

Placche in tecnopolimero "Ral 45" lucide "Ral 45" glossy finish moulded front plates

4 MODULI / 4 MODULES	Cod. Code	Descrizione Description	Info	€	<input type="checkbox"/>	<input type="checkbox"/>
	45P04BG	Bianco Banquise (RAL 9016) Banquise white (RAL 9016)	1	20		
	45P04NL	Nero lucido Polished black	1	20		

Armatura da utilizzare To be used with

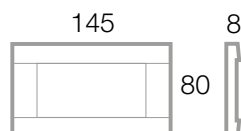

45764

Placche in tecnopolimero "Ral 45" lucide "Ral 45" glossy finish moulded front plates

6 MODULI / 6 MODULES	Cod. Code	Descrizione Description	Info	€	<input type="checkbox"/>	<input type="checkbox"/>
	45P06BG	Bianco Banquise (RAL 9016) Banquise white (RAL 9016)	1	15		
	45P06NL	Nero lucido Polished black	1	15		

Armatura da utilizzare To be used with

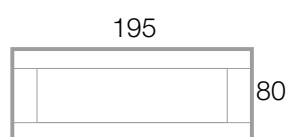

45366

Le dimensioni, salvo diversamente specificato, sono in mm
Dimensions, except where otherwise specified, are in mm

Prodotto per scatola quadrata
Product for British Standard square box only

Prodotto 1 modulo installabile in scatola tonda con altro prodotto 1 modulo
1 module product installable in round box with another 1 module device

Imballo Minimo pcs
Min. Packaging pcs

Imballo Standard pcs
Std. Packaging pcs



Placche

Front Plates

Sistema 45

Placche in tecnopolimero "Blanc 45"
"BLANC 45" moulded front plates

Design:
A. Van Onck

354

3 MODULI / 3 MODULES

Cod. Code Descrizione Description

Info

€ □ □

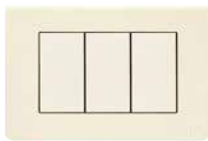

45P63

45P63 Bianco Blanc (RAL 1013)
Blanc white (RAL 1013)

1 25

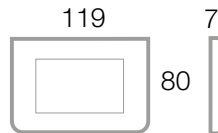

Armatura da utilizzare
To be used with



45B63

Placche in tecnopolimero "Blanc 45" "BLANC 45" moulded front plates

1 MODULO / 1 MODULE

Cod. Code Descrizione Description

Info

€ □ □



45P61

45P61 Bianco Blanc (RAL 1013)
Blanc white (RAL 1013)

1 25

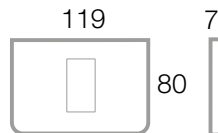

Armatura da utilizzare
To be used with



45B63

Placche in tecnopolimero "Blanc 45" "BLANC 45" moulded front plates

1+1 MODULI / 1+1 MODULES

Cod. Code Descrizione Description

Info

€ □ □

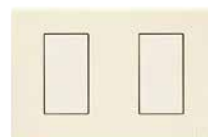

45P62 Bianco Blanc (RAL 1013)
Blanc white (RAL 1013)

1 25

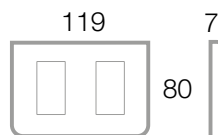

Armatura da utilizzare
To be used with



45B63

Placche in tecnopolimero "Blanc 45" "BLANC 45" moulded front plates

4 MODULI / 4 MODULES

Cod. Code Descrizione Description

Info

€ □ □



45P64 Bianco Blanc (RAL 1013)
Blanc white (RAL 1013)

1 20

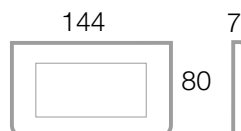

Armatura da utilizzare
To be used with



45764



Per la disponibilità contattare
la rete commerciale
For availability please contact
sales dept.



Disponibilità fino ad
esaurimento scorte
Available until stock out



Prodotto 2 moduli adatto
anche per scatola tonda
2 modules product suitable
for round box



Prodotto per scatola
rettangolare inglese
Product for British standard
rectangular box



Prodotto
per Export
For Export
only

Placche in tecnopolimero per scatola tonda o quadrata
Moulded front plates square or round box

Design:
A. Van Onck

1+1 MODULI / 1+1 MODULES	Cod. Code	Descrizione Description	Info	€	□	□
--------------------------	-----------	-------------------------	------	---	---	---

355



45P11R

45P11R	Grigio RAL 7035 RAL 7035 grey	1	20
--------	----------------------------------	---	----

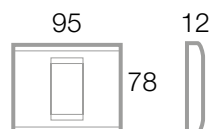

Armatura da utilizzare
To be used with



45363

Placche in tecnopolimero per scatola tonda o quadrata *Moulded front plates square or round box*

2 MODULI / 2 MODULES	Cod. Code	Descrizione Description	Info	€	□	□
----------------------	-----------	-------------------------	------	---	---	---



45P12BP	Bianco Blanc (RAL 1013) Blanc white (RAL 1013)	1	20
45P12R	Grigio RAL 7035 RAL 7035 grey	1	20

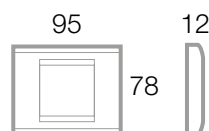

Armatura da utilizzare
To be used with



45363

Le dimensioni, salvo diversamente specificato, sono in mm
 Dimensions, except where otherwise specified, are in mm

◆ Prodotto per scatola quadrata
 Product for British Standard
 square box only

② Prodotto 1 modulo installabile in scatola tonda
 con altro prodotto 1 modulo
 1 module product installable in round box with
 another 1 module device

□ Imballo Minimo pcs
 Min. Packaging pcs

□ Imballo Standard pcs
 Std. Packaging pcs



Design:
B. Dall'Eco
L. Merletti

Serie Civili Sistema 45

System 45
Wiring Accessories

SERIE CIVILI
WIRING ACCESSORIES



357

Sistema 45
45 System

Supporti
Frames

358

Contenitori
Enclosures

362



45B61

Cod. Code	Descrizione Description	Info	€	□	□
45B61	Armatura 1 modulo per pannelli/profilati accoppiabile in verticale - con viti <i>1 module frame with fixing screws for section bars installations</i>	10	10		

Armature per scatole tonde e quadrate *Frames for round and square boxes*

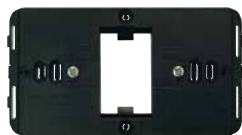

45361

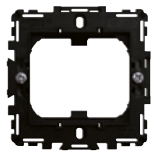

45362EX

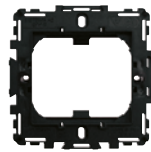

45362EX-SG



45363
F45363F



45361-N



45362-N



45762

Cod. Code	Descrizione Description	Info	€	□	□
45361	Armatura 1 modulo per scatola tonda 60mm per placche 45PY01..., 45P01..., 45P31, 45P61 <i>1 module frame for 60mm round box for plates 45PY01..., 45P01..., 45P31, 45P61</i>	50	50		
45361-N	Armatura 1 modulo per scatola quadrata - da utilizzare con placche 45PB91... <i>1 module frame for square box to be used with 45PB91 front plates</i>	50	50		
45362-N	Armatura 2 moduli per scatola quadrata - da utilizzare con placche 45PB92... <i>2 modules frame for square box to be used with 45PB92 front plates</i>	50	50		
45762	Armatura 2 moduli affiancati per placche 45P02... - 45P92... - 45PB02... - 45PY02... 45P622 - 45P722 - installabile su scatola quadrata con interasse 60mm (cod. AVE 2502) o standard rettangolare (cod. AVE 2503MG) 3 moduli <i>2 modules frame to be used with front plates 45P02... - 45P92... 45P622 - 45P722 - it can be installed on square boxes with centre distance 60 mm (code AVE 2502) or 3 modules rectangular standard (AVE code 2503MG)</i>	50	50		
45362EX	Armatura 1-2 moduli per scatola quadrata o tonda 60mm - accoppiabile in orizzontale o verticale - con griffe laterali <i>1-2 modules frame with side clips for squared or 60mm round boxes - it can be coupled either vertically or horizontally</i>	70	70		
45362EX-SG	Armatura 1-2 moduli per scatola quadrata o tonda 60mm accoppiabile in orizzontale o verticale - senza griffe <i>1-2 modules frame with no clips for squared or 60mm round boxes - it can be coupled either vertically or horizontally</i>	70	70		
45363	Armatura 1-2 moduli per scatola tonda 60mm o quadrata - con griffe - da utilizzare con placche 45P11...e 45P12... <i>1-2 modules frame for 60mm round box - with clips to be used with front plates codes 45P11...and 45P12...</i>	50	50		
F45363F	Armatura 1-2 moduli per scatola tonda Ø 60mm o quadrata - con griffe lunghe da utilizzare con placche 45P11...e 45P12... <i>1-2 modules frame for round box Ø 60mm or square box - with long clips to be used with front plates codes 45P11...and 45P12...</i>	100	100		



Per la disponibilità contattare la rete commerciale
For availability please contact sales dept.



Disponibilità fino ad esaurimento scorte
Available until stock out



Prodotto 2 moduli adatto anche per scatola tonda
2 modules product suitable for round box







Prodotto per scatola rettangolare inglese
Product for British standard rectangular box





Prodotto per Export
For Export only

Armature per scatole rettangolari Frames for rectangular boxes

	Cod. Code	Descrizione Description	Info	€	□	□
	45B63	Armatura 1-3 moduli per scatole 2503MG 1-3 modules frame for 2503MG boxes		120	120	
	45366	Armatura 6 moduli per scatole 2506 6 modules frame for 2506 boxes		8	8	
45B63	45762	Armatura 2 moduli affiancati per placche 45P02... - 45P92... - 45PB02... - 45PY02...45P622 - 45P722 - installabile su scatola quadrata con interasse 60mm (cod. AVE 2502) o standard rettangolare (cod. AVE 2503MG) - 3 moduli 2 modules frame to be used with front plates 45P02...-45P92... - 45PB02...45PY02...45P622 - 45P722 - it can be installed on square boxes with centre distance 60 mm (code AVE 2502) or 3 modules rectangular standard (AVE code 2503MG)		50	50	
	45764	Armatura 4 moduli per scatole 2504 4 modules frame for 2504 boxes		15	15	
45366	45B66	Armatura 6 moduli (3+3) per scatole BL02P, 45SY6 6 modules frame (3+3) for BL02P, 45SY6 boxes		8	8	
						
45764						
						
45B66						
						
45762						

Armature speciali Special frames

	Cod. Code	Descrizione Description	Info	€	□	□
	45360	Armatura 1-3 moduli per l'installazione di tutti i prodotti che per ragioni di dimensioni non possono essere installati nelle armature standard sistema 45 Ave quali: - prese rasoio cod. 45...33RS - microautomatici 3KA cod. 45...52NX6,45...52NX10, 45...52NX16 - magnetotermici differenziali cod. 45...62NX6, 45...62NX10, 45...62NX16 1-3 modules special frame for the devices that do not fit a standard S45 frame. The products that require this special frame are: - Shaver socket (45...33RS) - 3kA Micro MCBs (45...52NX6, 45...52NX10, 45...52NX16) - Micro combined MCB/RCDs (45...62NX6, 45...62NX10, 45...62NX16)		1	12	
45360	45364	Come sopra ma per 1-4 moduli As above, for 1-4 modules		1	12	
						
45364						

Nota: permettono inoltre, tramite gli appositi adattatori forniti in dotazione, di alloggiare tutti i frutti standard del sistema 45 Ave (vedi figura sotto riportata)

Note: All standard S45 modules can be fitted to these frames by using the dedicated adaptors (see picture below)

Esempio di installazione su Armatura 45360:
microinterruttore + presa schuko bypass del Sistema 45 AVE
Installation example 45360 Special Use Frame, micro MCB + System 45 schuko socket

I prodotti del Sistema 45 con aggancio standard si montano sulle armature 45360 - 45364 con l'utilizzo degli adattatori in dotazione con l'armatura.

System 45 products with standard clippings are fitted to Ref. 45360 and 45364 with the adaptors provided with the frames.

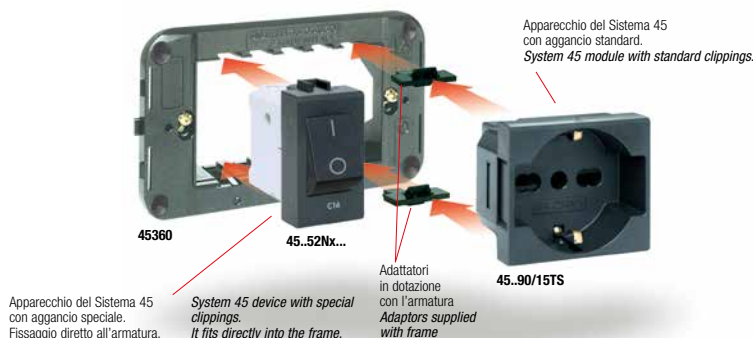

Le dimensioni, salvo diversamente specificato, sono in mm
Dimensions, except where otherwise specified, are in mm

◇ Prodotto per scatola quadrata
Product for British Standard square box only

② Prodotto 1 modulo installabile in scatola tonda con altro prodotto 1 modulo
1 module product installable in round box with another 1 module device

□ Imballo Minimo pcs
Min. Packaging pcs

□ Imballo Standard pcs
Std. Packaging pcs



Armature Frames

Sistema 45

Armature speciali per placche "Vera"
Special frames for "Vera" front plates

360

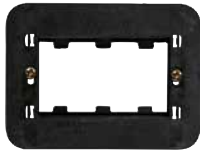

45V03

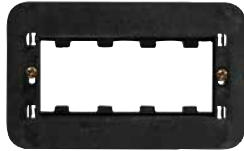

45V04

Cod. Code	Descrizione Description	Info	€	□	□
45V03	Armatura 3 moduli per scatola 2503MG - da utilizzare esclusivamente con placche "Vera" 3 moduli <i>3 modules frame for 2503MG box - to be used only with 3 modules "Vera" plates</i>	8	8		
45V04	Armatura 4 moduli per scatola 2504 - da utilizzare esclusivamente con placche "Vera" 4 moduli <i>4 modules frame for 2504 box - to be used with 4 modules "Vera" plates</i>	6	6		

Armature per moduli multipli Multi-module frames

Cod. Code	Descrizione Description	Info	€	□	□
45760/10	Armatura 10 moduli per scatole 53SA05, 53SA05BG, BL05P, BL05CG, 45SY10, 45SY10AO <i>10 modules frame for 53SA05, 53SA05BG, BL05P, 45SY10, 45SY10AO boxes</i>	1	1		
45760/15	Armatura 15 moduli per scatole BL06P <i>15 modules frame for BL06P boxes</i>	1	1		
45760/20	Armatura 20 moduli per scatole BL07P, 53SA12, 53SA12BG, 45SY20, 45SY20AO <i>20 modules frame for BL07P, 53SA12, 53SA12BG, 45SY20, 45SY20AO boxes</i>	1	1		



45760/10



45760/20

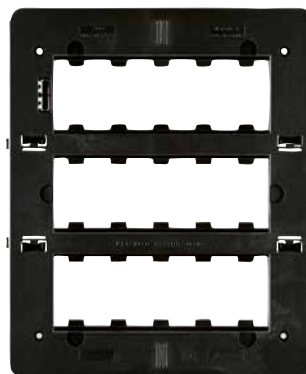

45760/15

Rimozione setto separatore

Divider removal



Per la disponibilità contattare la rete commerciale
For availability please contact sales dept.



Disponibilità fino ad esaurimento scorte
Available until stock out



Prodotto 2 moduli adatto anche per scatola tonda
2 modules product suitable for round box



Prodotto per scatola rettangolare inglese
Product for British standard rectangular box



Prodotto per Export
For Export only

Armature standard estero International standards frames



	Cod. Code	Descrizione Description	Info	€	□	□
	45362K	Armatura 2 moduli per scatola quadrata standard inglese 2 modules frame for square box UK standard		100	100	

45362K

361

Sistema 45



Accessori Accessories

	Cod. Code	Descrizione Description	Info	€	□	□
	VL0922	Vite lunga 35 mm per fissaggio armature su scatole incassate sotto il filo intonaco Long screw 35 mm to fix the frames on flush mounted wall-lined boxes		10	100	
	VL0923	Vite lunga 48 mm per fissaggio armature su scatole incassate sotto il filo intonaco Long screw 48 mm to fix the frames on flush mounted wall-lined boxes		100	100	

VL0922

VL0923

Accessori Accessories

	Cod. Code	Descrizione Description	Info	€	□	□
	53.45	Supporto 1 modulo per installazione frutti Sistema 45 su barra DIN 1 module adapter frame to install System 45 devices on DIN rail		20	20	
	53.45/2	Supporto 2 moduli per installazione frutti Sistema 45 su barra DIN 2 modules adapter frame to install System 45 devices on DIN rail		8	8	

53.45

53.45/2

Le dimensioni, salvo diversamente specificato, sono in mm
Dimensions, except where otherwise specified, are in mm

◇ Prodotto per scatola quadrata
Product for British Standard square box only

② Prodotto 1 modulo installabile in scatola tonda con altro prodotto 1 modulo
1 module product installable in round box with another 1 module device

□ Imballo Minimo pcs
Min. Packaging pcs

□ Imballo Standard pcs
Std. Packaging pcs



NORMATIVE
CEI EN 60529 (70-1)
CEI EN 60670-1 (23-48)

CEI EN 60529 (70-1)
CEI EN 60670-1 (23-48)

Le norme CEI EN 60529 (70-1) e CEI EN 60670-1 (23-48) prescrivono che "i gradi di protezione dichiarati restino immutati nelle condizioni ordinarie di servizio". Ne deriva che i contenitori per prese devono garantire il grado di protezione anche "nella condizione ordinaria di servizio" e dunque anche con inserita la spina di un qualsiasi apparecchio elettrico.

CEI EN 60529 (70-1) and CEI EN 60670-1 (23-48) standards prescribe that "declared protection degrees must remain unaltered in ordinary performing conditions". This means that enclosures for sockets must guarantee the protection degree "in ordinary performing conditions", also when any plug is in.

I normali contenitori per prese perdono il grado di protezione dichiarato (IP55) quando all'interno degli stessi è inserita una qualsiasi spina e lo sportello rimane aperto.

Usual enclosures for sockets lose their protection degree (IP55) every time a plug is in and the lid is open.



IERI
YESTERDAY

Contenitore per prese civili a membrana molle con spina inserita perde il grado di protezione IP55.

Enclosure for domestic sockets with soft membrane cover with plug in loses the IP55 protection degree.



CONTENITORE
IP40
PER APPARECCHI
DI COMANDO E
PRESE A SPINA

ENCLOSURE
FOR CONTROL DEVICES AND
SOCKET OUTLETS

CONTENITORE
IP55
PER APPARECCHI
DI COMANDO

ENCLOSURE
FOR CONTROL
DEVICES



I normali contenitori sono dunque adatti a contenere comandi (interruttori, deviatori, pulsanti o altri apparecchi modulari che consentono la chiusura dello sportello nella condizione ordinaria di servizio) mentre per le prese vanno utilizzati contenitori in grado di garantire il grado di protezione anche a spina inserita.

Usual enclosures are suitable for control devices (switches, push-buttons or other modular devices which allows the closure of the lid) while the sockets must be installed on enclosures which guarantee the protection degree also with plug-in.

La gamma AVE SEAL, brevetto AVE già vincitore di numerosi premi di settore, rende disponibili numerose soluzioni installative che garantiscono il mantenimento del grado di protezione dichiarato anche a spina inserita.

AVE SEAL range, AVE patent who has already won several awards, offers many installing solutions which guarantees the protection degree also with plug-in.

Ave Seal

OGGI
TODAY



CONTENITORE AVESEAL

IP56

PER PRESE A
SPINA INSERITA

*AVE SEAL ENCLOSURE
FOR SOCKET OUTLETS
WITH PLUG-IN*





Contenitori

Enclosures

Sistema 45

Contenitori industriali autoportanti IP40 da parete RAL7035 per tubo
IP40 indust. wall mounted enclosures for duct - self-supporting - RAL7035

Dimensioni d'ingombro (in mm) *Dimensions (mm)*

Caratteristiche Tecniche *Technical Features*

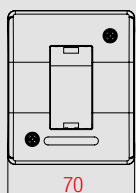

45Q41

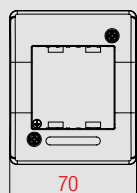
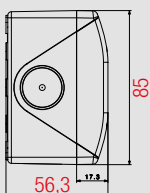

45Q42

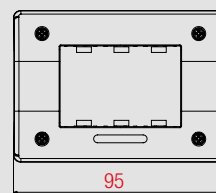
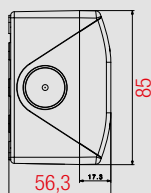

45Q43

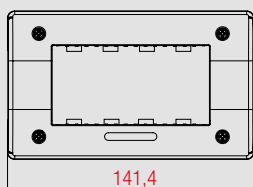
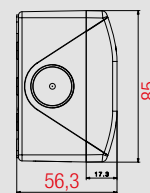

45Q44

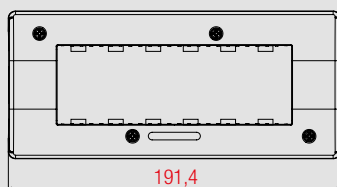
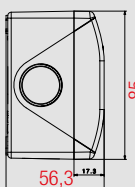

45Q46

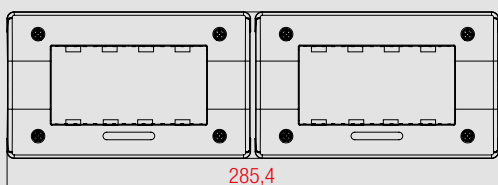
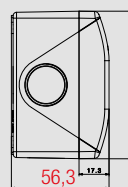

45Q48R

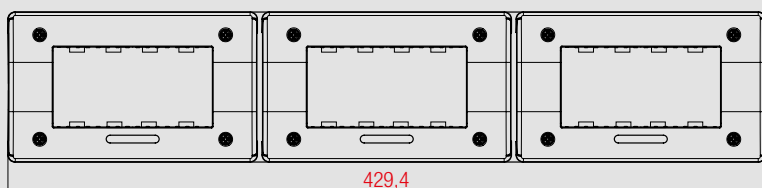
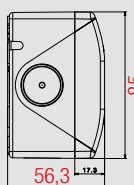

45Q4120R

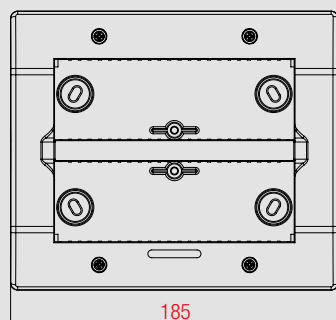
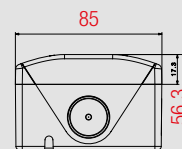
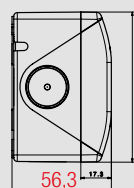

45Q412

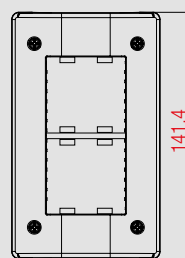
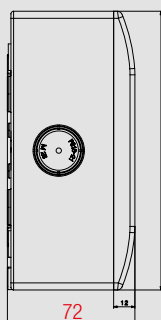

45Q44V

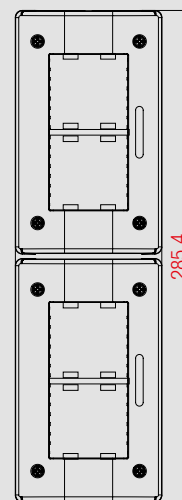
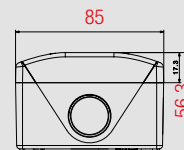

45Q48V



Per la disponibilità contattare la rete commerciale
For availability please contact sales dept.



Disponibilità fino ad esaurimento scorte
Available until stock out



Prodotto 2 moduli adatto anche per scatola tonda
2 modules product suitable for round box







Prodotto per scatola rettangolare inglese
Product for British standard rectangular box



Prodotto per Export
For Export only

Contenitori industriali autoportanti IP40 da parete RAL7035 per tubo
IP40 indust. wall mounted enclosures for duct - self-supporting - RAL7035

	Cod. Code	Descrizione Description	Info	€	□	□
	45Q41	1 modulo <i>1 module</i>		24	24	
	45Q42	2 moduli <i>2 modules</i>		24	24	
	45Q43	3 moduli <i>3 modules</i>		20	20	
	45Q44	4 moduli <i>4 modules</i>		20	20	
	45Q44V	4 (2+2) moduli - installazione verticale <i>4 (2+2) modules - vertical installation</i>		20	20	
	45Q46	6 moduli <i>6 modules</i>		1	10	
	45Q48V	8 (2+2+2+2) moduli - installazione verticale <i>8 (2+2+2+2) modules - vertical installation</i>		1	6	
	45Q43	8 (4+4) moduli - installazione orizzontale <i>8 (4+4) modules - horizontal installation</i>		1	6	
	45Q412	12 (6+6) moduli - installazione verticale <i>12 (6+6) modules - vertical installation</i>		1	6	
	45Q4120R	12 (4+4+4) moduli - installazione orizzontale <i>12 (4+4+4) modules - horizontal installation</i>		1	18	
	45Q44	Scatola di derivazione da parete <i>Wall mounted junction box</i>		1	20	

45Q41

45Q42

45Q43

45Q44

45Q46

45Q480R

45Q44V

45Q48V

45ST99

45Q4120R

45Q412

Le dimensioni, salvo diversamente specificato, sono in mm
 Dimensions, except where otherwise specified, are in mm

◆ Prodotto per scatola quadrata
 Product for British Standard square box only

② Prodotto 1 modulo installabile in scatola tonda con altro prodotto 1 modulo
 1 module product installable in round box with another 1 module device

□ Imballo Minimo pcs
 Min. Packaging pcs

□ Imballo Standard pcs
 Std. Packaging pcs



Contenitori

Enclosures

Sistema 45

Contenitori autoportanti IP40 da parete RAL1013
IP40 wall mounted enclosures - self-supporting - RAL1013

366

Dimensioni d'ingombro (in mm) *Dimensions (mm)*

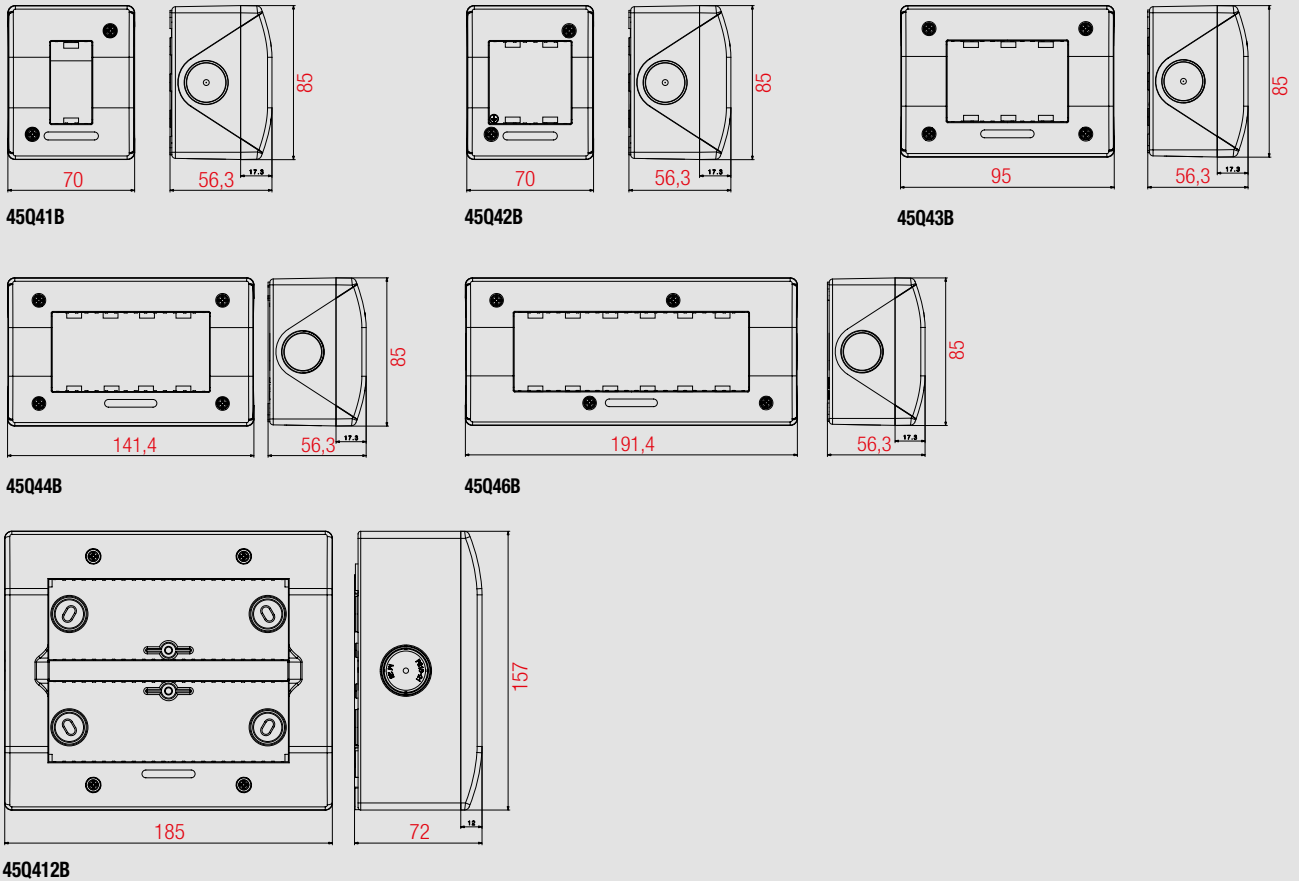
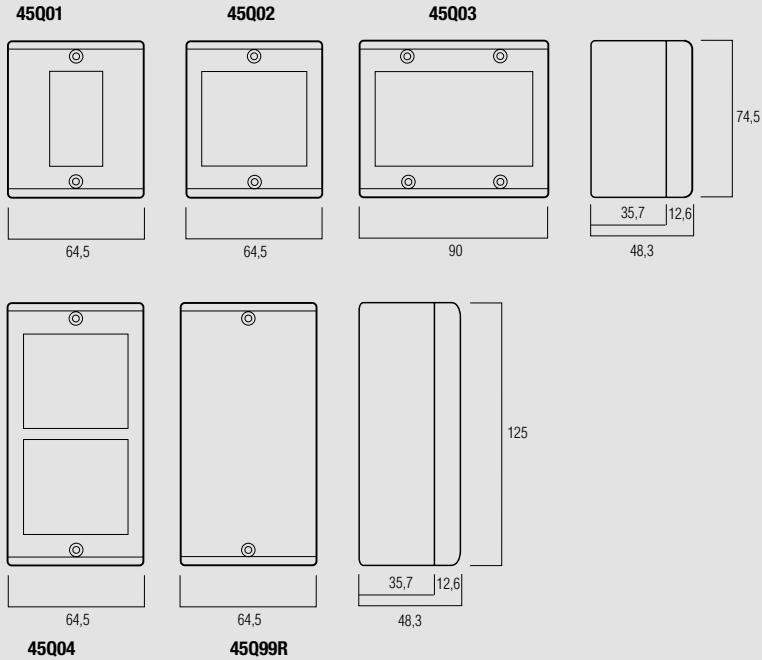

Caratteristiche Tecniche *Technical Features*



Per la disponibilità contattare la rete commerciale
For availability please contact sales dept.



Disponibilità fino ad esaurimento scorte
Available until stock out



Prodotto 2 moduli adatto anche per scatola tonda
2 modules product suitable for round box





Prodotto per scatola rettangolare inglese
Product for British standard rectangular box



Prodotto per Export
For Export only

Contenitori autoportanti IP40 da parete RAL1013

IP40 wall mounted enclosures - self-supporting - RAL1013

	Cod. Code	Descrizione Description	Info	€	<input type="checkbox"/>	<input type="checkbox"/>
	45Q01	1 modulo 1 module		30	30	
	45Q02	2 moduli 2 modules		30	30	
	45Q03	3 moduli 3 modules		24	24	
	45Q04	4 (2+2) moduli - installazione verticale 4 (2+2) modules - vertical installation		20	20	
	45Q12	12 (6+6) moduli - installazione verticale 12 (6+6) modules - vertical installation		1	6	
	45Q99R	Scatola di derivazione a parete - colore RAL7035 Wall mounted junction box - RAL7035 colour		20	20	

45Q01

45Q02



45Q03





45Q04



45Q12

Contenitori industriali autoportanti IP40 da parete RAL 9016 per tubo

IP40 indust. wall mounted enclosures for duct- self-supporting - RAL 9016

	Cod. Code	Descrizione Description	Info	€	<input type="checkbox"/>	<input type="checkbox"/>
	45Q41B	1 modulo 1 module		24	24	
	45Q42B	2 moduli 2 modules		24	24	
	45Q43B	3 moduli 3 modules		20	20	
	45Q44B	4 moduli 4 modules		20	20	
	45Q46B	6 moduli 6 modules		1	10	
	45Q412B	12 (6+6) moduli 12 (6+6) modules		1	6	

45Q41B

45Q42B



45Q43B



45Q44B



45Q46B



45Q412B

Le dimensioni, salvo diversamente specificato, sono in mm
Dimensions, except where otherwise specified, are in mm

Prodotto per scatola quadrata
Product for British Standard square box only

Prodotto 1 modulo installabile in scatola tonda con altro prodotto 1 modulo
1 module product installable in round box with another 1 module device

Imballo Minimo pcs
Min. Packaging pcs

Imballo Standard pcs
Std. Packaging pcs



Contenitori

Enclosures

Sistema 45

Contenitori autoportanti IP40 da parete RAL9016 "Yesmin" - per minicanale
"Yesmin" wall mounted IP40 Enclosures RAL 9016 - self-supporting - for mini trunkings

368



45QY1BB



45QY2BB

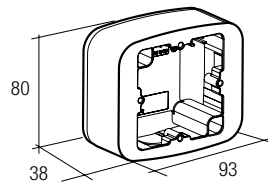

45QY1BB
45QY2BB

Cod. Code	Descrizione Description	Info	€	□	□
45QY1BB	1 modulo 1 module	1	30		
45QY2BB	2 moduli 2 modules	1	30		

Scatole portafrutto da parete RAL 9016 per placche "YES 45" - per minicanale
Wall mounted boxes for "YES 45" front plates RAL 9016 - for mini trunkings



45SY02



45SY2



45SY3

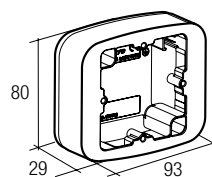

45SY02

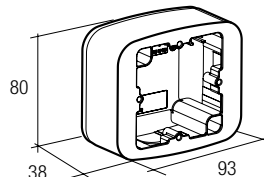

45SY2

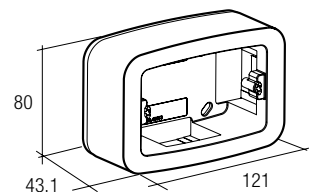

45SY3

Cod. Code	Descrizione Description	Info	€	□	□
45SY02	1-2 moduli - profondita ridotta - colore bianco Banquise 1-2 modules Banquise white reduced depth box	1	30		
45SY2	1-2 moduli - colore bianco Banquise 1-2 modules Banquise white box	1	30		
45SY3	3 moduli - colore bianco Banquise - da utilizzare con armatura standard 3 moduli 45B63 - da completare con placche codice 45PY01..., 45PY002..., 45PY02..., 45PY03... 3 modules Banquise white box to be used with 45B63 frames and 45PY01..., 45PY02..., 45PY002..., 45PY03... front plates	1	24		



Per la disponibilità contattare la rete commerciale
For availability please contact sales dept.



Disponibilità fino ad esaurimento scorte
Available until stock out



Prodotto 2 moduli adatto anche per scatola tonda
2 modules product suitable for round box





Prodotto per scatola rettangolare inglese
Product for British standard rectangular box



Prodotto per Export
For Export only

Scatole portafrutto da parete per placche "MAXI YES" - per minicanale
Wall mounted boxes for "MAXI YES" front plates - for mini trunkings

	Cod. Code	Descrizione Description	Info	€	□	□
	45SY6	6 moduli (3+3) - colore Bianco Banquise - da utilizzare con armatura 45B66 - da completare con placche codice 45PY033... <i>6 modules (3+3) banquise white box to be used with 45B66 frames and 45PY033.. front plates</i>	1	15		
45SY6	45SY10	10 moduli (5+5) - colore Bianco Banquise - da utilizzare con armatura 45760/10 - da completare con placche codice 45PY010... <i>10 modules (5+5) banquise white box to be used with 45760/10 frames and 45PY010.. front plates</i>	1	6		
	45SY20	20 moduli (5+5+5+5) - colore Bianco Banquise - da utilizzare con armatura 45760/20 - da completare con placche codice 45PY020..., 45PY10DIN... <i>20 modules (5+5+5+5) banquise white box to be used with 45760/20 frames and 45PY020..., 45PY10DIN front plates</i>	1	5		
						

369

Sistema 45

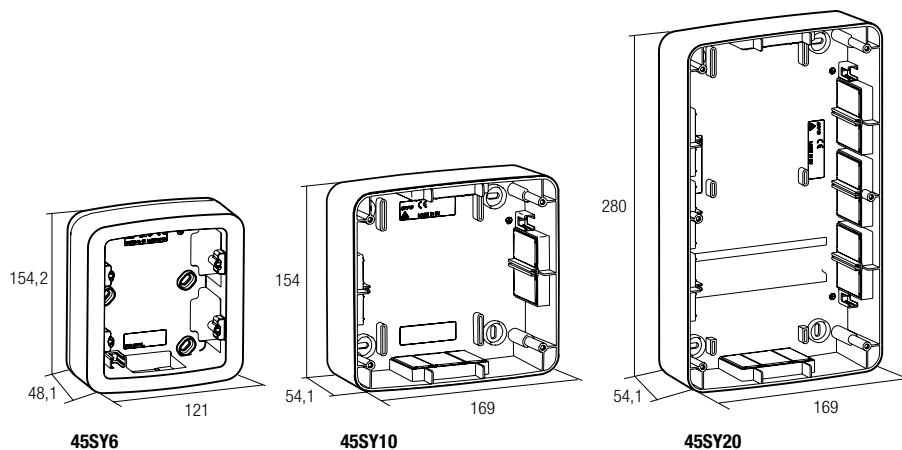

Le dimensioni, salvo diversamente specificato, sono in mm
 Dimensions, except where otherwise specified, are in mm

◆ Prodotto per scatola quadrata
 Product for British Standard square box only

② Prodotto 1 modulo installabile in scatola tonda con altro prodotto 1 modulo
 1 module product installable in round box with another 1 module device

□ Imballo Minimo pcs
 Min. Packaging pcs

□ Imballo Standard pcs
 Std. Packaging pcs



Scatole Universali IP40 per minicanali RAL 9010 IP40 RAL 9010 Universal boxes for mini trunkings

370



44SC03



44SC04

Cod. Code	Descrizione Description	Info	€	□	□
44SC03	3 moduli - da utilizzare con armature standard 3 moduli (interasse 83,5 mm) - per minicanali da 20x10 mm a 30x18 mm <i>3 modules - to be used with standard 3 modules frames (centre distance 83,5 mm) for trunkings from 20x10 mm to 30x18 mm</i>	1	20		
44SC04	4 moduli - da utilizzare con armature standard 4 moduli (interasse 108 mm) - per minicanali da 20x10 mm a 30x18 mm <i>4 modules - to be used with standard 4 modules frames (centre distance 108 mm) for trunkings from 20x10 mm to 30x18 mm</i>	1	15		

Nota: adatte anche per placche Sistema 44

Note: suitable also for System 44 front plates

44QC01

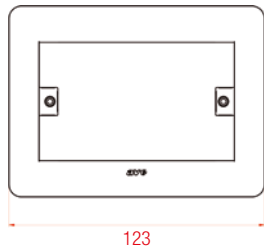

123

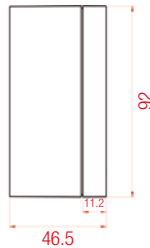

46.5

44QC03

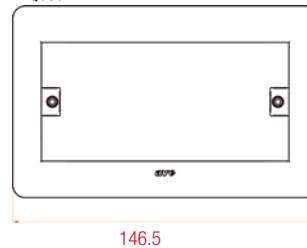

146.5

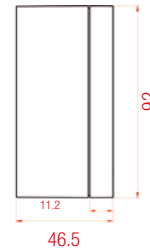

46.5

Scatole portafrutto da parete per placche "Ral 45" e "Zama 45" Wall mounted boxes for "Ral 45" and "Zama 45" front plates



45SA03



45SA03GN



45CI03

Cod. Code	Descrizione Description	Info	€	□	□
45SA03	Scatola d'arredo 3 moduli bianco Banquise (RAL 9016) - da utilizzare con armature standard 3 moduli - completare con placche codice 45P93... o 45P03... <i>3 modules white box to be used with System 45 3 modules frames to be completed with 45P93... or 45P03... front plates</i>	1	16		
45SA03GN	Scatola d'arredo 3 moduli grigio Noir - da utilizzare con armature standard 3 moduli. - completare con placche codice 45P93... o 45P03... <i>3 modules Noir grey box to be used with System 45 3 modules frames to be completed with 45P93... or 45P03... front plates</i>	1	16		
45CI03	Cornice rialzatrice inclinata 3 moduli bianco Banquise (RAL 9016) <i>3 modules Banquise white (RAL 9016) angled raiser frame</i>	1	1		



Per la disponibilità contattare la rete commerciale
For availability please contact sales dept.



Disponibilità fino ad esaurimento scorte
Available until stock out



Prodotto 2 moduli adatto anche per scatola tonda
2 modules product suitable for round box



Prodotto per scatola rettangolare inglese
Product for British standard rectangular box



Prodotto per Export
For Export only

Scatole portafrutto da parete per placche "Zama 45" multimodulo

Wall mounted boxes for "Zama 45" multi-module front plates

Cod. Code	Descrizione Description	Info	€	□	□
53SA05	Scatola RAL 7035 - da utilizzare con armature 45760/10 moduli Completare con placche codice 45P910..., 45P010... o 45PMX... <i>10 modules RAL 7035 box to be used with System 45 45760/10 frames to be completed with 45P910..., 45P010... or 45PMX... front plates</i>	1	8		
53SA05BG	Scatola bianco Banquise - da utilizzare con armature 45760/10 moduli Completare con placche codice 45P910... o 45PMX... <i>10 modules white box to be used with System 45 45760/10 frames to be completed with 45P910... or 45PMX... front plates</i>	1	8		



53SA05

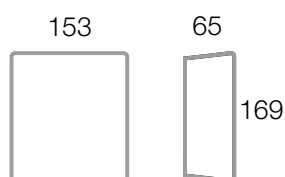

53SA05

371

Sistema 45

Modalità d'impiego Instructions

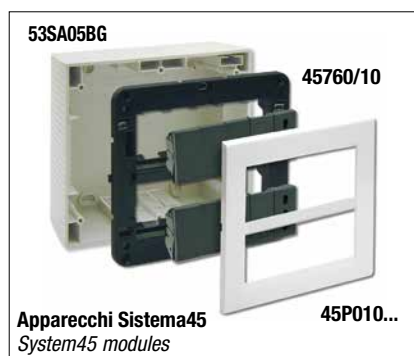

Pretranciatura che permette la copertura di scatole preesistenti
Pre-cutting for covering existing boxes



Sede per microinterruttore antisportazione
Seat for anti-removal micro-switch



Le dimensioni, salvo diversamente specificato, sono in mm
Dimensions, except where otherwise specified, are in mm

◇ Prodotto per scatola quadrata
Product for British Standard
square box only

② Prodotto 1 modulo installabile in scatola tonda
con altro prodotto 1 modulo
1 module product installable in round box with
another 1 module device

□ Imballo Minimo pcs
Min. Packaging pcs

□ Imballo Standard pcs
Std. Packaging pcs



Contenitori

Enclosures

Scatole e contenitori da tavolo
Desktop box and enclosures

Sistema 45

372



45SI03GN



45TL3BMC

Cod. Code	Descrizione Description	Info	€	□	□
45SI03GN	Scatola inclinata 3 moduli grigio Noir - da utilizzare con armature standard 3 moduli - completare con placche codice 45P93... o 45P03... <i>3 modules Noir grey angled box to be used with System 45 3 modules frames to be completed with 45P93... or 45P03... front plates</i>	1	1		
45TL3BMC	Contenitore autoportante da tavolo 3 moduli bianco Banquise (RAL 9016) - completo di placca color bianco Banquise micalizzato <i>3 modules Banquise white (RAL 9016) desktop enclosure with mica-finished Banquise white front plate</i>	1	12		

Placche stagne (IP44) con sportello rigido IP44 front plates with rigid cover



45SPQ02

Cod. Code	Descrizione Description	Info	€	□	□
45SPQ02	Placca 2 moduli con sportello rigido - autoportante (non necessita di armatura portafrutti) - fissaggio con viti su scatola quadrata con interasse 60mm - RAL 7035 <i>IP44 2 modules front plate with rigid cover - self-supporting (no frame is required) To be fixed by screws on square box interax 60mm - RAL 7035</i>	1	8		

Nota: grado di protezione garantito IP44 con apparecchi di comando o altri apparecchi modulari che consentano la chiusura dello sportello nella condizione ordinaria di servizio

Note: IP44 protection degree guaranteed with control devices or other modular devices that allow the closure of the lid in ordinary performing conditions

ESEMPIO di utilizzo Application example



1



2

INSTALLAZIONE INSTALLATION



Scatola da incasso cod. 2502
Flush-mounted box code 2502



Apparecchi Sistema 45 AVE
System 45 AVE devices

Sportello rigido antiurto: non ingiallisce anche se esposto a raggi solari diretti
Anti-shock rigid cover: it doesn't yellow even if directly exposed to sunbeams



Per la disponibilità contattare la rete commerciale
For availability please contact sales dept.



Disponibilità fino ad esaurimento scorte
Available until stock out



Prodotto 2 moduli adatto anche per scatola tonda
2 modules product suitable for round box









Prodotto per scatola rettangolare inglese
Product for British standard rectangular box



Prodotto per Export
For Export only





Placche stagne (IP55) autoportanti con sportello con membrana cedibile

IP55 front plates with soft membrane cover - self-supporting

		Cod. Code	Descrizione Description	Info	€	□	□
		45SP43N	Placca 3 moduli stagna con membrana - autoportante (non necessita di armatura portafrutti) - grigio RAL 7035 <i>IP55 splashproof 3 modules front plate with soft membrane cover - self-supporting (no frame is required) - RAL 7035 grey</i>	6	6		
		45SP43BN	Placca 3 moduli stagna con membrana - autoportante (non necessita di armatura portafrutti) - bianco Banquise (RAL 9016) <i>IP55 splashproof 3 modules front plate with soft membrane cover - self-supporting (no frame is required) - Banquise white (RAL 9016)</i>	6	6		
		45SP43BPN	Placca 3 moduli stagna con membrana - autoportante (non necessita di armatura portafrutti) - bianco Blanc (RAL 1013) <i>IP55 splashproof 3 modules front plate with soft membrane cover - self-supporting (no frame is required) - Blanc white (RAL 1013)</i>	6	6		
		45SP43GM	Placca 3 moduli stagna con membrana - autoportante (non necessita di armatura portafrutti) - grigio metallizzato <i>IP55 splashproof 3 modules front plate with soft membrane cover - self-supporting (no frame is required) - Metallic grey</i>	6	6		
		45SP44	Placca 4 moduli stagna con membrana - autoportante (non necessita di armatura portafrutti) grigio RAL 7035 <i>4 modules splash proof front plate - self-supporting (no frame is required) - RAL 7035 grey</i>	6	6		
		45SP44B	Placca 4 moduli stagna con membrana autoportante (non necessita di armatura portafrutti) bianco Banquise (RAL 9016) <i>4 modules splash proof front plate - self-supporting (no frame is required) - Banquise white (RAL 9016)</i>	6	6		
			Nota: grado di protezione garantito IP55 con apparecchi di comando o altri apparecchi modulari che consentano la chiusura dello sportello nella condizione ordinaria di servizio Note: IP55 protection degree guaranteed with control devices or other modular devices that allow the closure of the cover in ordinary performing conditions				

Contenitori stagni (IP44) autoportanti da parete con sportello rigido

IP44 wall mounted enclosures with rigid cover - self-supporting

		Cod. Code	Descrizione Description	Info	€	□	□
		45ST41	1 modulo - colore RAL 7035 <i>1 module - RAL 7035 colour</i>	20	20		
		45ST42	2 moduli - colore RAL 7035 <i>2 modules - RAL 7035 colour</i>	20	20		
		45ST41BB	1 modulo - bianco Banquise (RAL 9016) <i>1 module - Banquise white (RAL 9016) colour</i>	20	20		
		45ST42BB	2 moduli - bianco Banquise (RAL 9016) <i>2 modules - Banquise white (RAL 9016) colour</i>	20	20		
			Nota: grado di protezione garantito IP44 con apparecchi di comando o altri apparecchi modulari che consentano la chiusura dello sportello nella condizione ordinaria di servizio Note: IP44 protection degree guaranteed with control devices or other modular devices that allow the closure of the cover in ordinary performing conditions				

Le dimensioni, salvo diversamente specificato, sono in mm
Dimensions, except where otherwise specified, are in mm

◆ Prodotto per scatola quadrata
Product for British Standard square box only

② Prodotto 1 modulo installabile in scatola tonda con altro prodotto 1 modulo
1 module product installable in round box with another 1 module device

□ Imballo Minimo pcs
Min. Packaging pcs

□ Imballo Standard pcs
Std. Packaging pcs



Contenitori

Enclosures

Contenitori stagni (IP55) autoportanti da parete RAL 7035 con sportello a membrana cedibile per tubo
IP55 wall mounted enclosures RAL 7035 with soft membrane cover - self-supporting for duct

374

Dimensioni d'ingombro (in mm) *Dimensions (mm)*

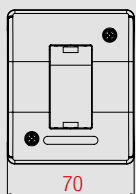

45Q41B

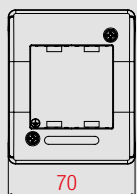
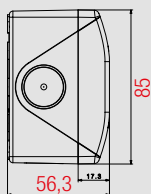

45Q42B

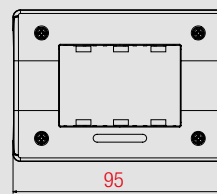
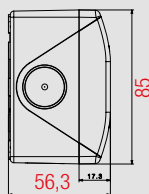

45Q43B

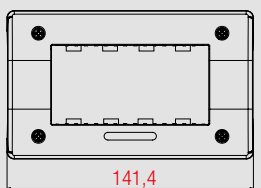
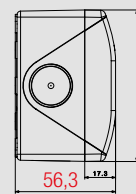

45Q44B

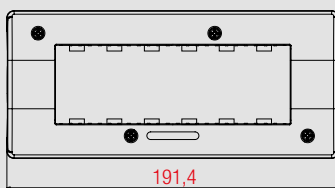
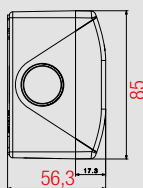

45Q46B

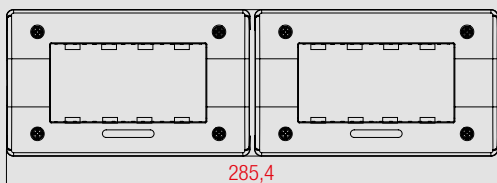
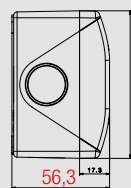

45Q480R

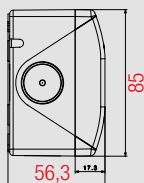

Caratteristiche Tecniche *Technical Features*



Per la disponibilità contattare la rete commerciale
For availability please contact sales dept.



Disponibilità fino ad esaurimento scorte
Available until stock out



Prodotto 2 moduli adatto anche per scatola tonda
2 modules product suitable for round box



Prodotto per scatola rettangolare inglese
Product for British standard rectangular box



Prodotto per Export
For Export only

Contenitori stagni (IP55) autoportanti da parete RAL 7035 con sportello a membrana cedibile per tubo IP55 wall mounted enclosures RAL 7035 with soft membrane cover - self-supporting for duct

Cod. Code	Descrizione Description	Info	€	□	□
45ST01	Contenitore da parete 1 modulo 1 module wall mounted enclosure	1	24		
45ST02	Contenitore da parete 2 moduli 2 modules wall mounted enclosure	1	24		
45ST03	Contenitore da parete 3 moduli 3 modules wall mounted enclosure	1	20		
45ST04	Contenitore da parete 4 moduli 4 modules wall mounted enclosure	20	20		
45ST080R	Contenitore da parete 8 (4+4) moduli - installazione orizzontale 8 (4+4) modules wall mounted enclosure - horizontal installation	1	6		
45ST99	Scatola di derivazione da parete Wall mounted junction box	1	20		



45ST01



45ST02



45ST03



45ST04



45ST080R



45ST99

Nota: grado di protezione garantito IP55 con apparecchi di comando o altri apparecchi modulari che consentano la chiusura dello sportello nella condizione ordinaria di servizio

Note: IP55 protection degree guaranteed with control devices or other modular devices that allow the closure of the lid in ordinary performing conditions

375

Sistema 45

Accessori per contenitori da parete IP40 e IP55 Accessories for IP40 and IP55 wall mounted enclosures

Cod. Code	Descrizione Description	Info	€	□	□
44PC00	Passacavo/passatubo universale - da applicare a sfondabili Ø 24 mm Universal conduit entry - to be fixed on breakable holes Ø 24mm	10	10		
45BMT	Adattatore per installazione orizzontale di interruttori automatici magnetotermici su armature standard Sistema 45 o su contenitori/scatole da parete IP40/IP55 - 2 moduli Adaptor for horizontal installation of MCBs on standard System 45 frames or in wall mounted enclosures/boxes IP40/IP55 - 2 modules	1	6		
45PC00	Passacavo/passatubo universale filettato - da applicare a sfondabili Ø 24 mm Universal threaded conduit entry - to be fixed on breakable holes Ø 24mm	10	10		
45PRT20	Pressatubo per tubi Ø 20mm - da applicare a sfondabili Ø 24mm Tube gland for tubes Ø 20mm - to be fixed on breakable holes Ø 24mm	5	5		
45RD03	Raccordo di giunzione scatole per passaggio cavi - da applicare a sfondabili Ø 24mm Box coupler for cables passage - to be fixed on breakable holes Ø 24mm	10	10		



45BMT



44PC00



45PC00



45RD03



45PRT20

Le dimensioni, salvo diversamente specificato, sono in mm
Dimensions, except where otherwise specified, are in mm

◇ Prodotto per scatola quadrata
Product for British Standard square box only

② Prodotto 1 modulo installabile in scatola tonda con altro prodotto 1 modulo
1 module product installable in round box with another 1 module device

□ Imballo Minimo pcs
Min. Packaging pcs

□ Imballo Standard pcs
Std. Packaging pcs



Contenitori

Enclosures

Contenitori AVE SEAL IP56 da parete per tubo
AVE SEAL IP56 wall mounted enclosures for duct

376

Dimensioni d'ingombro (in mm) *Dimensions (mm)*

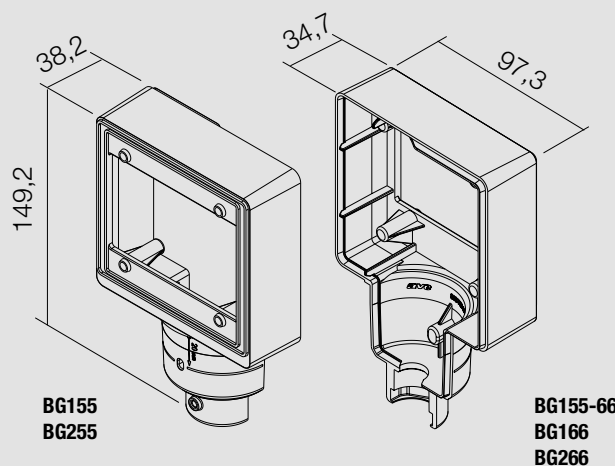
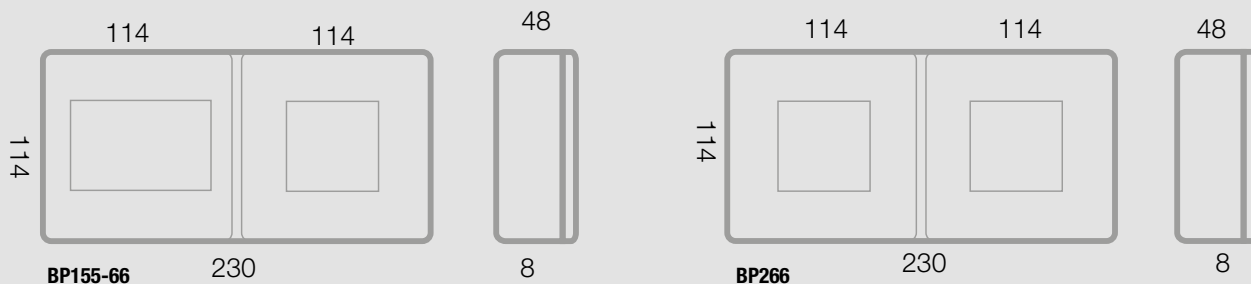
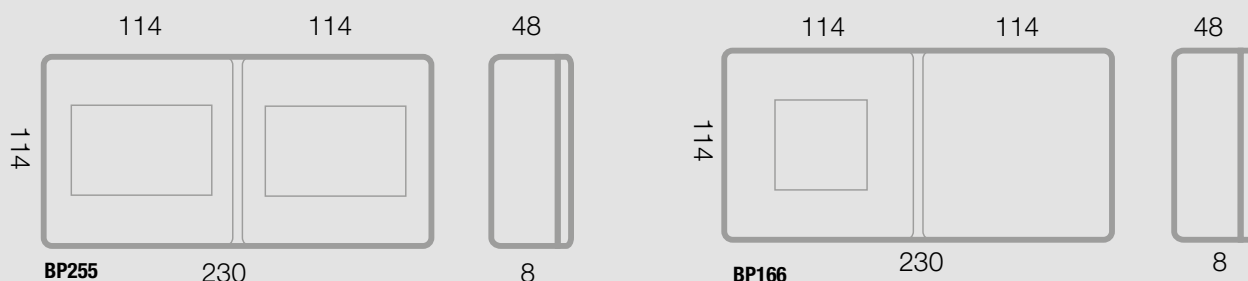
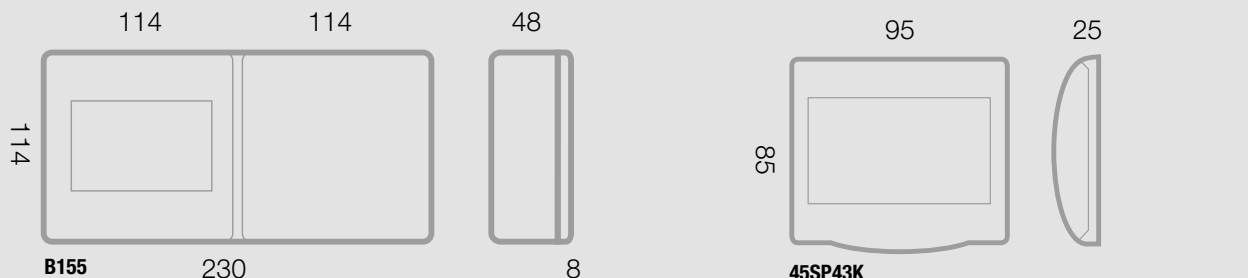

Caratteristiche Tecniche *Technical Features*



Per la disponibilità contattare la rete commerciale
For availability please contact sales dept.



Disponibilità fino ad esaurimento scorte
Available until stock out



Prodotto 2 moduli adatto anche per scatola tonda
2 modules product suitable for round box







Prodotto per scatola rettangolare inglese
Product for British standard rectangular box



Prodotto per Export
For Export only

Contenitori AVE SEAL IP56 da parete per tubo



AVE SEAL IP56 wall mounted enclosures for duct

	Cod. Code	Descrizione Description	Info	€	□	□
	45ST02K	Contenitore AVE SEAL 2 moduli stagno con sportello apribile a cerniera grado di protezione garantito IP56 <u>anche con spina inserita</u> <i>IP56 splashproof 2 modules enclosure with opening cover guaranteed IP56 protection degree also with plug in</i>		1	2	
45ST02K						
	45ST590/15TS	Contenitore AVE SEAL stagno con sportello apribile a cerniera completo di presa schuko bipasso (universale) 2P+T 10/16A 250V grado di protezione garantito IP56 <u>anche con spina inserita</u> <i>IP56 splashproof with opening cover + 2P+E 10/16A 250V combined schuko + Italian standard socket (universal) - guaranteed IP56 protection also with plug in</i>		1	2	
45ST590/15TS						

377



Sistema 45

Soluzione AVE SEAL IP55 da incasso Flush-mounted enclosure AVE SEAL IP55 solution

	Cod. Code	Descrizione Description	Info	€	□	□
	45STPK	Piastra adattatrice coperchio AVE SEAL 2 moduli a scatola 3 moduli rettangolare - da completare con n° 1 45SP42K <i>Adapter for IP55 2 modules cover on 3 module rectangular box to be completed with n. 1 45SP42K</i>		1	8	
45STPK						
	45SP42K	Coperchio AVE SEAL 2 moduli con sportello apribile a cerniera <i>2 modules IP55 cover with opening cover with hinge</i>		1	10	
45SP42K						

Soluzioni AVE SEAL IP55/IP56 multiple da parete per tubo

Wall mounted double enclosures AVE SEAL IP55/IP56 solutions for duct

	Cod. Code	Descrizione Description	Info	€	□	□
	45SP42K	Coperchio AVE SEAL 2 moduli con sportello apribile a cerniera <i>2 modules AVE SEAL cover with opening lid with hinge</i>		1	10	
45SP42K						
	45SP43K	Coperchio 3 moduli con sportello con membrana cedibile <i>3 modules cover with soft membrane lid</i>		1	8	
45SP43K						

Le dimensioni, salvo diversamente specificato, sono in mm
Dimensions, except where otherwise specified, are in mm

◇ Prodotto per scatola quadrata
Product for British Standard square box only

② Prodotto 1 modulo installabile in scatola tonda con altro prodotto 1 modulo
1 module product installable in round box with another 1 module device

□ Imballo Minimo pcs
Min. Packaging pcs

□ Imballo Standard pcs
Std. Packaging pcs



Contenitori

Enclosures

Sistema 45

Soluzioni AVE SEAL IP55/IP56 multiple da parete per tubo
Wall mounted double enclosures AVE SEAL IP55/IP56 solutions for duct

378



BP255



BP155-66

Cod. Code Descrizione Description Info € □ □

BP255	Box da parete per 6 (3+3) moduli IP55 - da completare con n° 2 45SP43K grado di protezione garantito IP55 con apparecchi di comando (*) <i>Wall mounted box for 6 (3+3) modules IP55 - to be completed with n° 2 45SP43K - guaranteed IP55 protection degree with control devices (*)</i>		1	1
-------	--	--	---	---

BP155-66	Box da parete per 3 moduli IP55 + 2 moduli AVE SEAL - da completare con n° 1 45SP43K + n° 1 45SP42K - grado di protezione garantito IP55 con apparecchi di comando (*) da un lato e prese dall'altro <i>Wall mounted box for IP55 3 modules + AVE SEAL 2 modules to be completed with n°1 45SP43K + n° 1 45SP42K - IP55 protection degree guaranteed with control devices (*) on the one hand and sockets on the other hand</i>		1	1
----------	--	--	---	---

(*) o altri apparecchi modulari che consentano la chiusura dello sportello nella condizione ordinaria di servizio

(*) or other modular devices which allow the closure of the cover

Esempi installativi Installation examples



Per la disponibilità contattare la rete commerciale
For availability please contact sales dept.



Disponibilità fino ad esaurimento scorte
Available until stock out



Prodotto 2 moduli adatto anche per scatola tonda
2 modules product suitable for round box





Prodotto per scatola rettangolare inglese
Product for British standard rectangular box



Prodotto per Export
For Export only

Soluzioni AVE SEAL IP55/IP56 multiple da parete per tubo
Wall mounted double box AVE SEAL IP55/IP56 solutions for duct

	Cod. Code	Descrizione Description	Info	€	<input type="checkbox"/>	<input type="checkbox"/>
 BP166	BP166	Box da parete per 2 moduli AVE SEAL IP56 + piastra cieca - da completare con n° 1 45SP42K - grado di protezione garantito IP56 <u>anche con spina inserita</u> <i>Wall mounted box for AVE SEAL IP56 2 modules + blank plate - to be completed with n°1 45SP42K - guaranteed IP56 protection degree also with plug in</i>			1	1
	BP266	Box da parete per 4 (2+2) moduli AVE SEAL IP56 - da completare con n° 2 45SP42K - grado di protezione garantito IP56 <u>anche con spina inserita</u> <i>Wall mounted box for AVE SEAL IP56 4 (2+2) modules - to be completed with n°2 45SP42K - guaranteed IP56 protection degree also with plug in</i>			1	1



BP266

Sistema 45



Le dimensioni, salvo diversamente specificato, sono in mm
 Dimensions, except where otherwise specified, are in mm

 Prodotto per scatola quadrata
 Product for British Standard square box only

 Prodotto 1 modulo installabile in scatola tonda con altro prodotto 1 modulo
 1 module product installable in round box with another 1 module device

 Imballo Minimo pcs
 Min. Packaging pcs

 Imballo Standard pcs
 Std. Packaging pcs



Contenitori

Enclosures

Soluzioni AVE SEAL IP55/IP56 abbraccio palo
Pole fixing AVE SEAL IP55/IP56 solutions

Sistema 45

380



45SP42K



45SP43K



BG155



BG255



BG155-66



BG166



BG266



BG100

Cod. Code	Descrizione Description	Info	€	□	□
45SP42K	Coperchio AVE SEAL 2 moduli con sportello apribile a cerniera 2 modules AVE SEAL cover with opening lid with hinge		1	10	
45SP43K	Coperchio 3 moduli con sportello con membrana cedibile 3 modules cover with soft membrane lid		1	8	
BG155	Box testa-palo a 1 fronte IP55 - installabile su palo BG100 - da completare con n° 1 45SP43K - grado di protezione garantito IP55 con apparecchi di comando (*) Box on pole top with 1 IP55 front - to be installed on pole BG100 to be completed with n. 1 45SP43K - IP55 protection degree guaranteed with control devices (*)		1	1	
BG255	Box testa-palo a 2 fronti IP55 - installabile su palo BG100 - da completare con n° 2 45SP43K - grado di protezione garantito IP55 con apparecchi di comando (*) Box on pole top with 2 IP55 fronts - to be installed on pole BG100 to be completed with n. 2 45SP43K - IP55 protection degree guaranteed with control devices (*)		1	1	
BG155-66	Box testa-palo a 2 fronti IP56 + IP55 - installabile su palo BG100 - da completare con n° 1 45SP42K + n° 1 45SP43K - grado di protezione garantito IP55 con apparecchi di comando (*) da un lato e prese dall'altro Box on pole top with 2 IP56 + IP55 fronts - to be installed on pole BG100 to be completed with n. 1 45SP42K - IP55 protection degree guaranteed with control devices (*) on the one hand and sockets on the other hand		1	1	
BG166	Box testa-palo a 1 fronte IP56 - installabile su palo BG100 - da completare con n° 1 45SP42K - grado di protezione garantito IP56 <u>anche con spina inserita</u> Box on pole top with 1 IP56 front - to be installed on pole BG100 to be completed with n. 1 45SP42K - guaranteed IP56 protection degree <u>also with plug in</u>		1	1	
BG266	Box testa-palo a 2 fronti IP56 - installabile su palo BG100 - da completare con n° 2 45SP42K - grado di protezione garantito IP56 <u>anche con spina inserita</u> Box on pole top with 2 IP56 fronts - to be installed on pole BG100 to be completed with n. 2 45SP42K - guaranteed IP56 protection degree <u>also with plug in</u>		1	1	
BG100	Palo isolante per box testa palo - Ø esterno 60mm - lunghezza 1 Insulating pole for garden enclosures - external Ø 60mm - length 1m		1	1	

(*) o altri apparecchi modulari che consentano la chiusura dello sportello nella condizione ordinaria di servizio

(*) or others modular devices which allow the closure of the cover

Nota: le dimensioni dei contenitori sono riportate a pag. 388

Nota: le dimensioni dei contenitori sono riportate a pag. 388



Per la disponibilità contattare la rete commerciale
For availability please contact sales dept.



Disponibilità fino ad esaurimento scorte
Available until stock out



Prodotto 2 moduli adatto anche per scatola tonda
2 modules product suitable for round box





Prodotto per scatola rettangolare inglese
Product for British standard rectangular box



Prodotto per Export
For Export only

Soluzione AVE SEAL IP56 abbraccio palo

Pole fixing AVE SEAL IP56 solution

	Cod. Code	Descrizione Description	Info	€	□	□
	BG101AP	Accessorio abbraccio palo per contenitore IP56 - installabile su pali con diametro 55/60mm e con diametro 35/40mm a mezzo fascette standard non fornite in dotazione - da completare con n° 1 45ST02K - grado di protezione garantito IP56 <i>Accessory to fix the IP56 enclosure at the pole to be installed on poles with diameter 55/60mm and on poles with diameter 35/40 by standard bands that are not supplied - to be completed with n. 1 45ST02K - guaranteed IP56 protection degree</i>		1	10	
	45ST02K	Contenitore AVE SEAL 2 moduli stagno con sportello apribile a cerniera - grado di protezione garantito IP56 <u>anche con spina inserita</u> <i>IP56 splashproof 2 modules enclosure with opening lid guaranteed IP56 protection degree also with plug in</i>		1	2	
	BG100	Palo isolante per box testa palo - Ø esterno 60mm - lunghezza 1m <i>Insulating pole for garden enclosures - external Ø 60mm - length 1m</i>		1	1	

BG101AP



45ST02K



BG100

Accessori per contenitori stagni (IP56) da parete

Accessories for IP56 wall mounted enclosures

	Cod. Code	Descrizione Description	Info	€	□	□
	45PRT16	Pressatubo per tubi Ø 16mm - da applicare a sfondabili Ø 20mm <i>Tube gland for tubes Ø 16mm - to be fixed on breakable holes Ø 20mm</i>		10	10	
	45PRT20	Pressatubo per tubi Ø 20mm - da applicare a sfondabili Ø 24mm <i>Tube gland for tubes Ø 20mm - to be fixed on breakable holes Ø 24mm</i>		5	5	
	45PR01	Passacavo per cavi fino a 13mm - da applicare a sfondabili Ø 20mm <i>Cable gland for cables until 13mm - to be fixed on breakable holes Ø 20mm</i>		10	10	
	45RD03	Raccordo di giunzione scatole per passaggio cavi - da applicare a sfondabili Ø 24mm <i>Box coupler for cables passage - to be fixed on breakable holes Ø 24mm</i>		10	10	

45PRT16

45PRT20

45PR01

45RD03

Le dimensioni, salvo diversamente specificato, sono in mm
Dimensions, except where otherwise specified, are in mm

◇ Prodotto per scatola quadrata
Product for British Standard square box only

② Prodotto 1 modulo installabile in scatola tonda con altro prodotto 1 modulo
1 module product installable in round box with another 1 module device

□ Imballo Minimo pcs
Min. Packaging pcs

□ Imballo Standard pcs
Std. Packaging pcs